

Sestava B&C Speakers 12HPL76 + DE500/16 + ME45

Osazení:

- B&C Speakers 12HPL76 8/Ohm
<http://eshop.prodance.cz/DetailPage.asp?DPG=82710>
- B&C Speakers DE500/16 16/Ohm
<http://eshop.prodance.cz/DetailPage.asp?DPG=82311>
- B&C Speakers ME45
<http://eshop.prodance.cz/DetailPage.asp?DPG=79828>

Schéma výhybky:

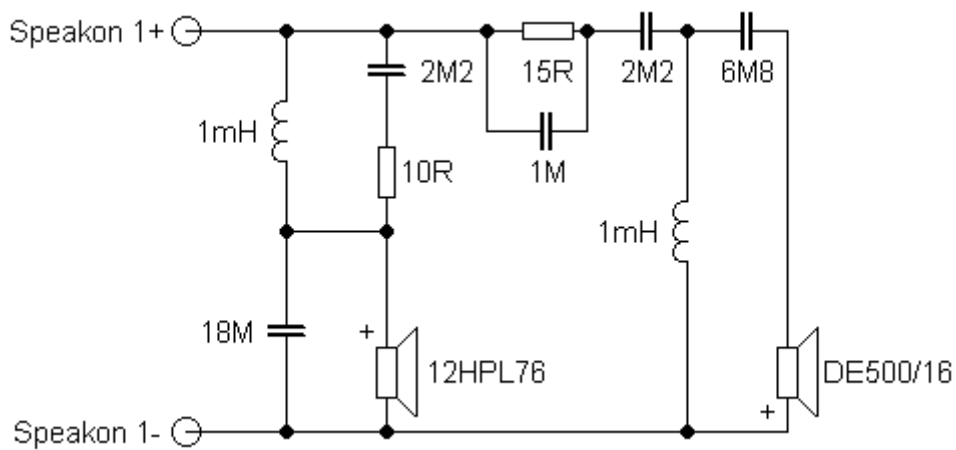

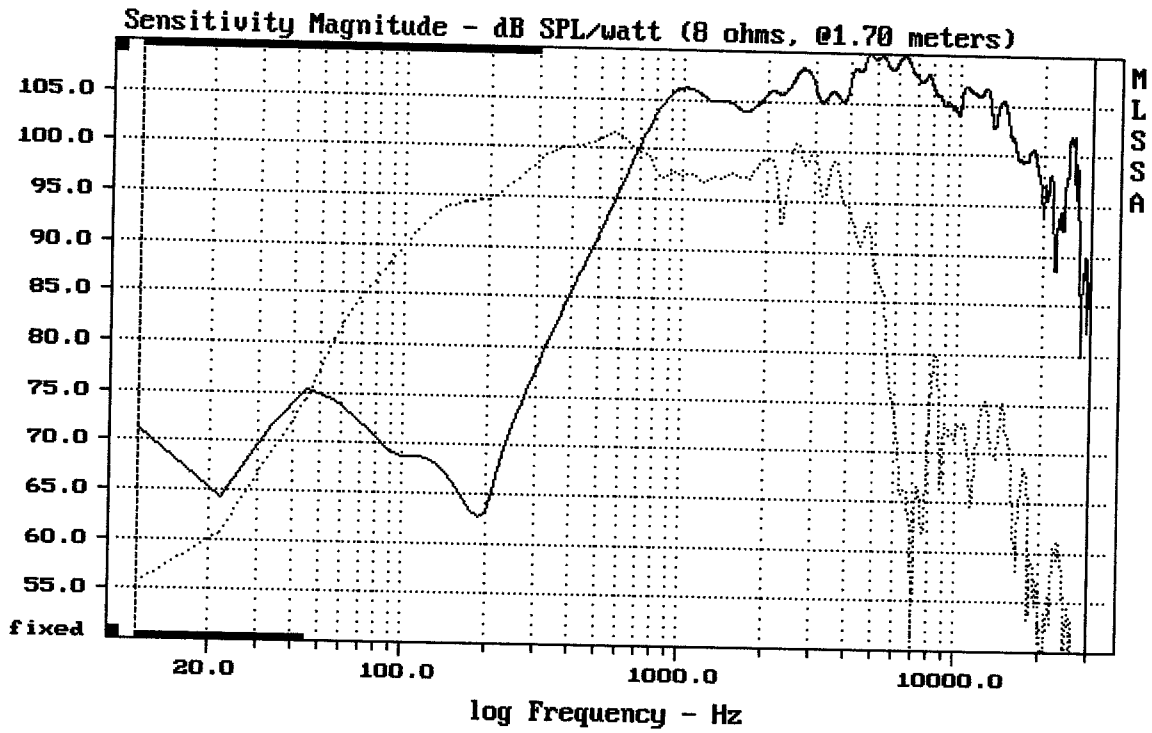

CURSOR: $dy = -43.2691$ $x = 30007.1014$ (2704)

12HPL76 + DE500/16 + ME45

MLSSA: Frequency Domain

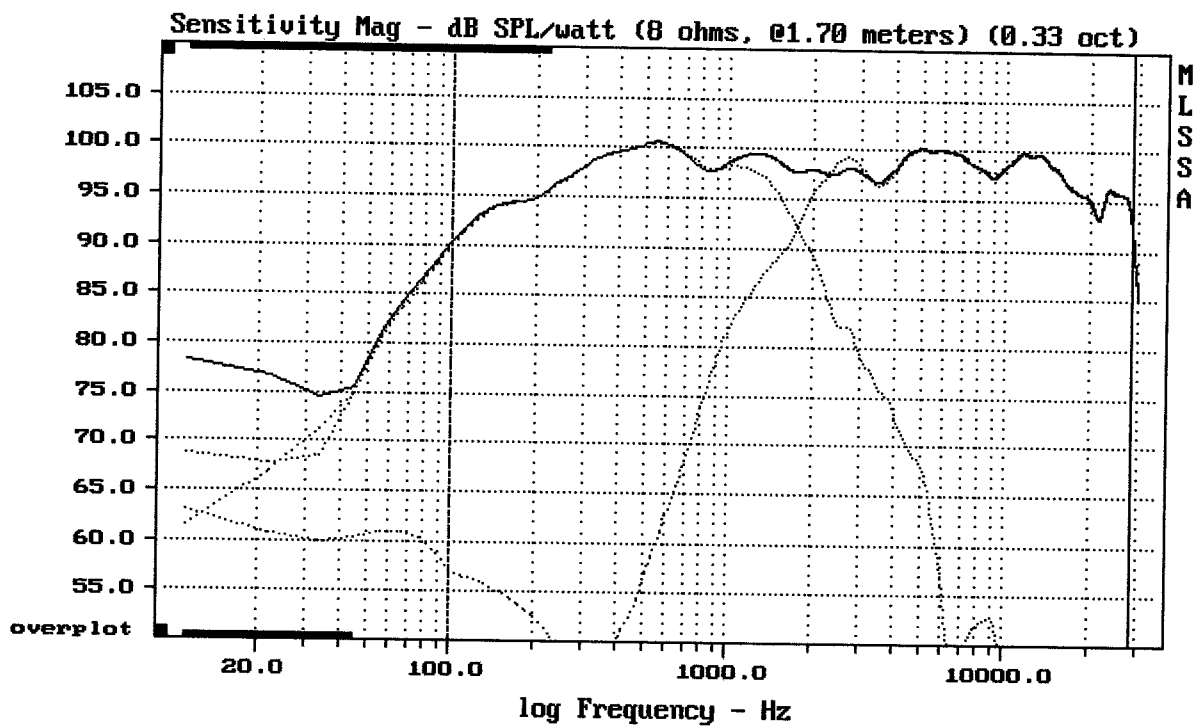

Level (100:20509 Hz) = 98.04 dB SPL/watt (8 ohms, @1.70 meters) (0.33 oct)

12HPL76 + DE500/16 + ME45

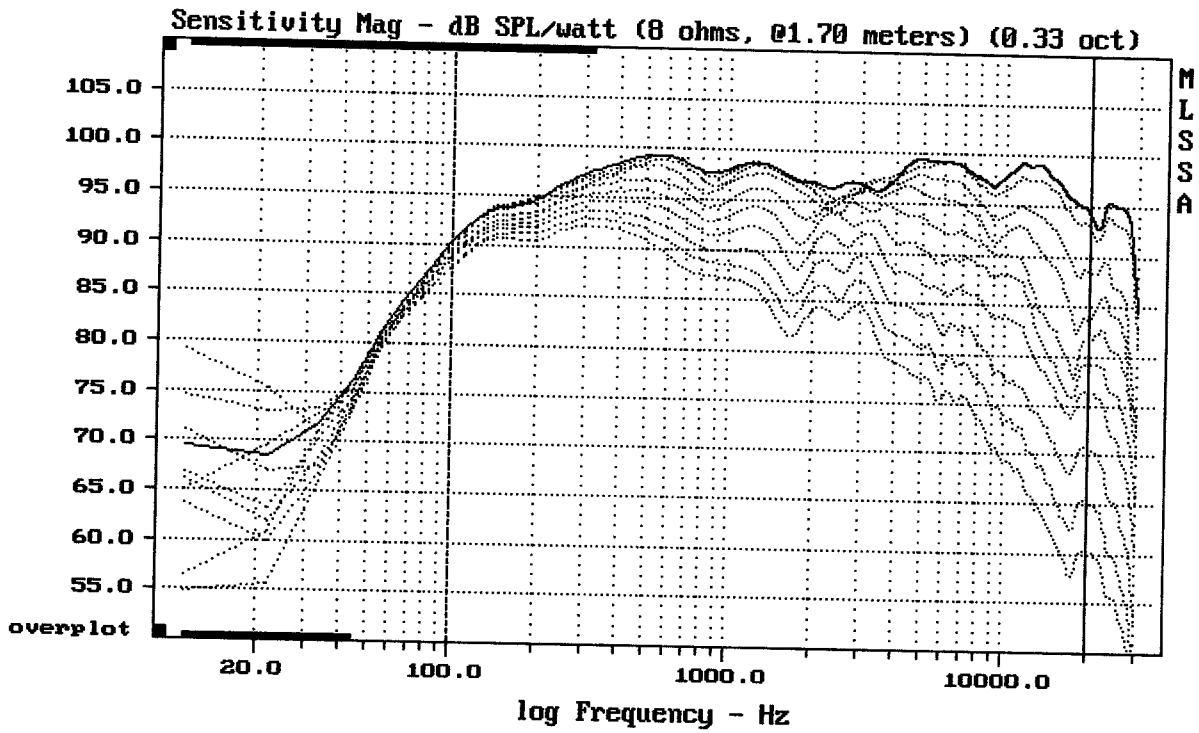

Overlay Compare: dev= +24/-11, std= 8.8, avg= -27

12HPL76 + DE500/16 + ME45

MLSSA: Frequency Domain

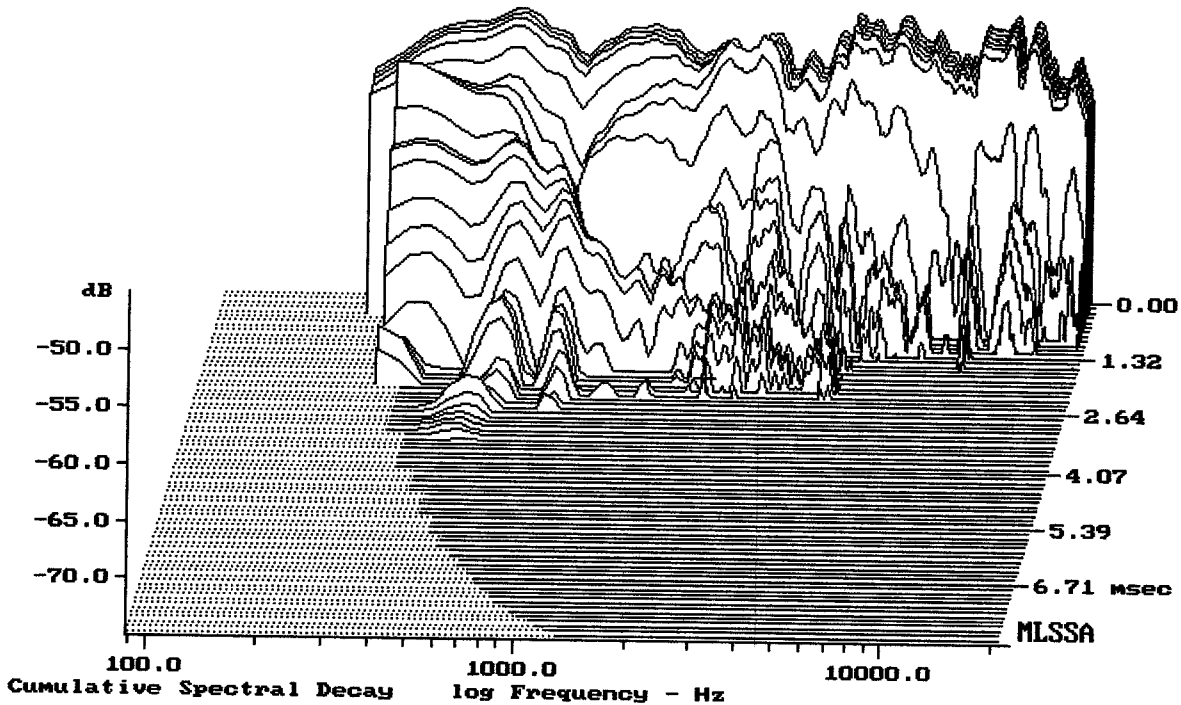

-73.44 dB, 2131 Hz (48), 2.310 msec (22)

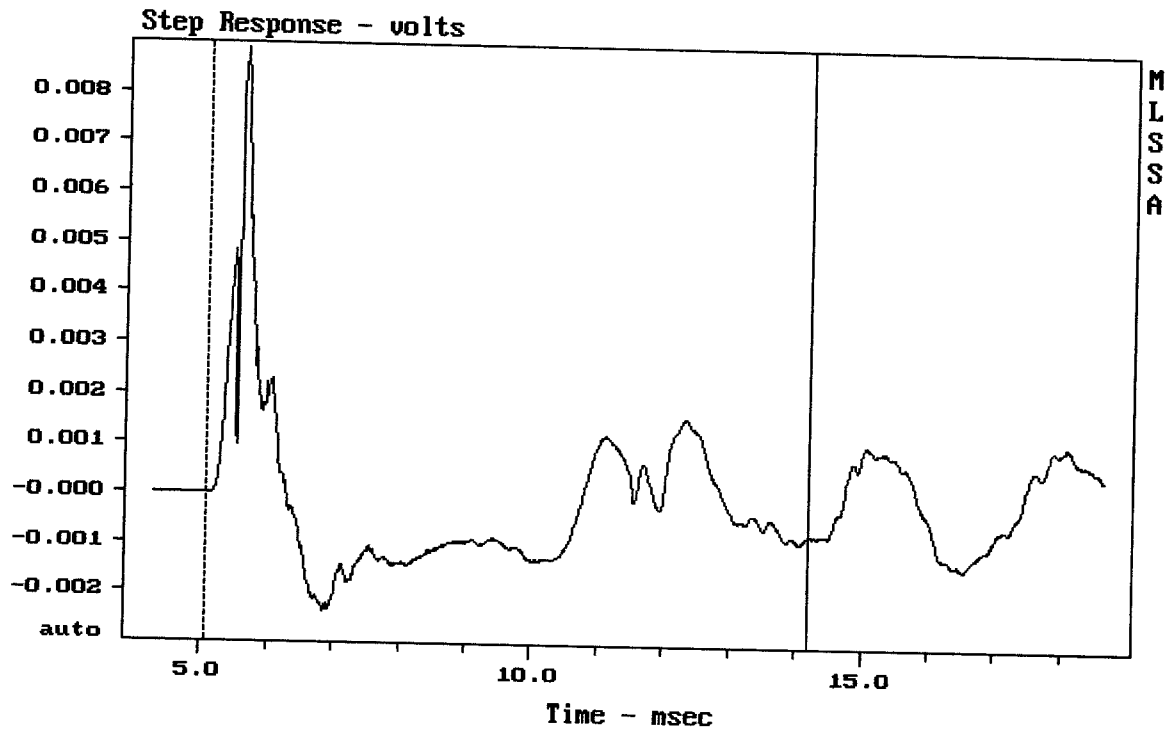

mean: -0.0001701, rms: 0.001642, std: 0.001633, max: 0.008874, min: -0.00236

12HPL76 + DE500/16 + ME45

MLSSA: Time Domain

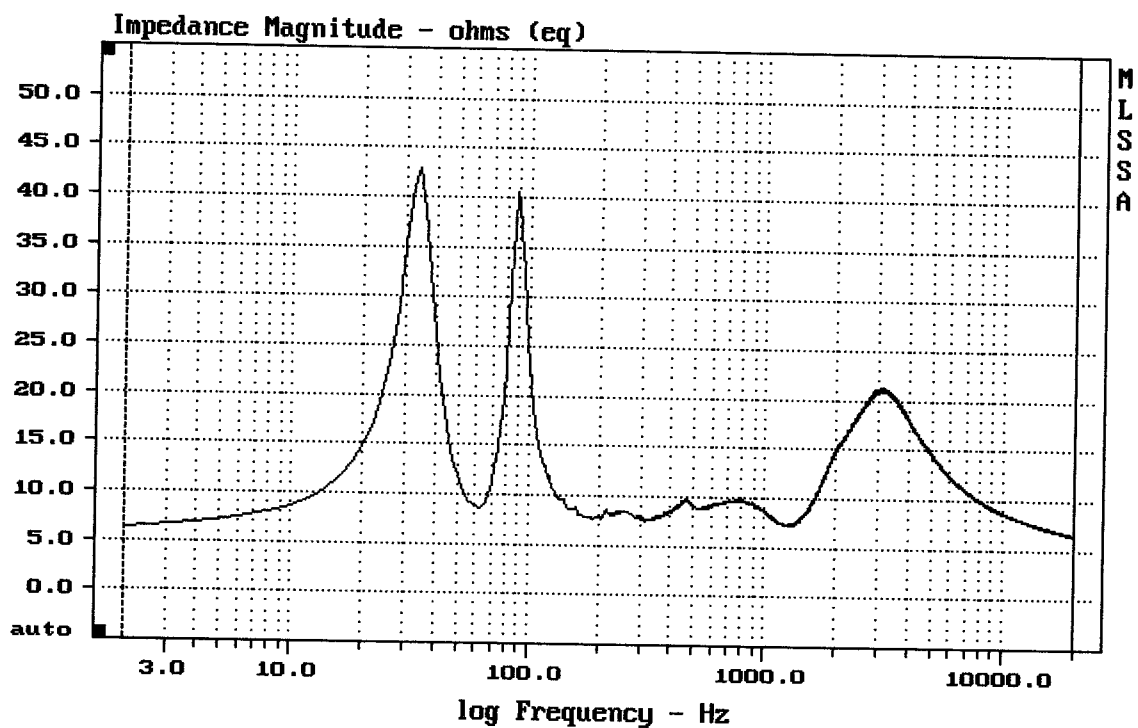

mean: 10.11, rms: 10.91, std: 4.102, max: 42.84, min: 6.366

12HPL76 + DE500/16 + ME45