

## Sestava B&C Speakers 12MH32 + Fane CD150 + Megaton A9090t

### Osazení:

- B&C Speakers 12MH32 8/Ohm  
<http://eshop.prodance.cz/DetailPage.asp?DPG=82718>
- Fane CD150 8/Ohm  
<http://eshop.prodance.cz/DetailPage.asp?DPG=90670>
- Megaton A9090t  
<http://eshop.prodance.cz/DetailPage.asp?DPG=83923>

### Schéma výhybky:

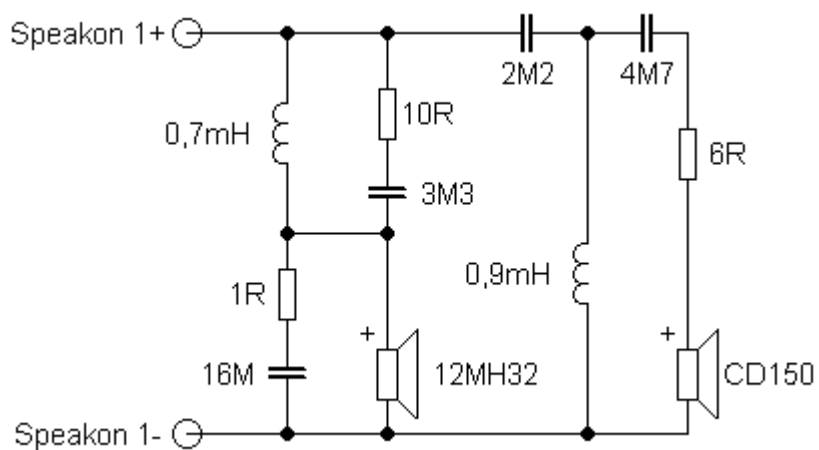

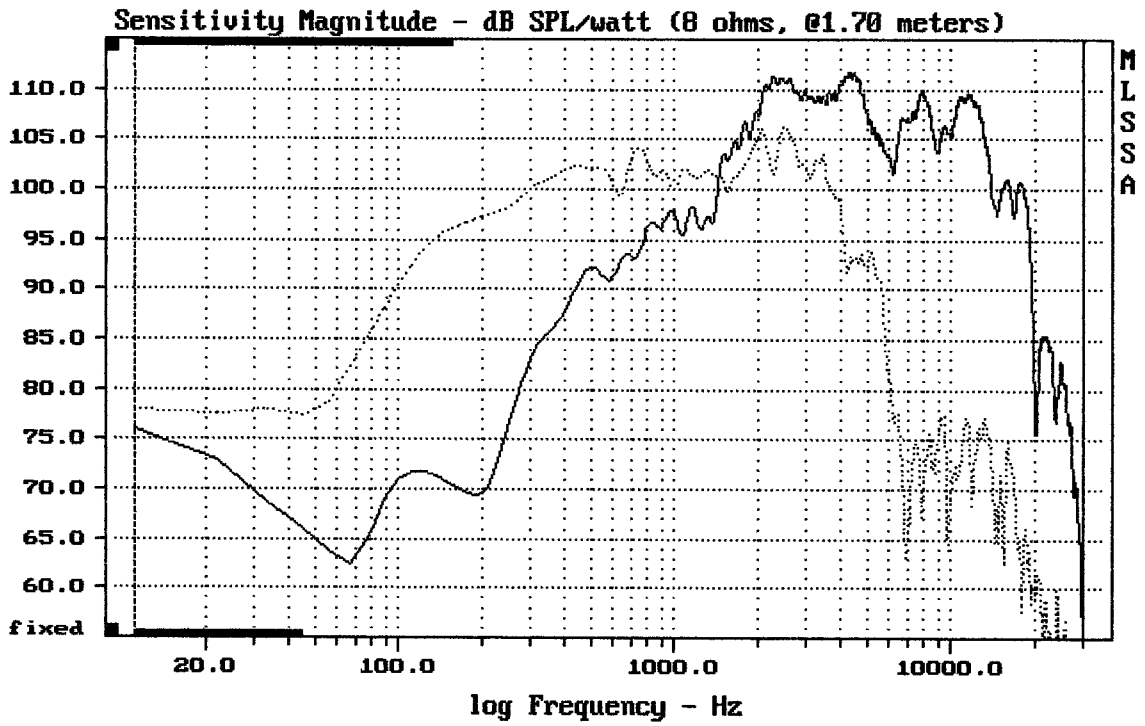

CURSOR:  $\Delta y = -17.4651$   $x = 30007.1014$  (2704)

12MH32 + CD150 + A9090t

MLSSA: Frequency Domain

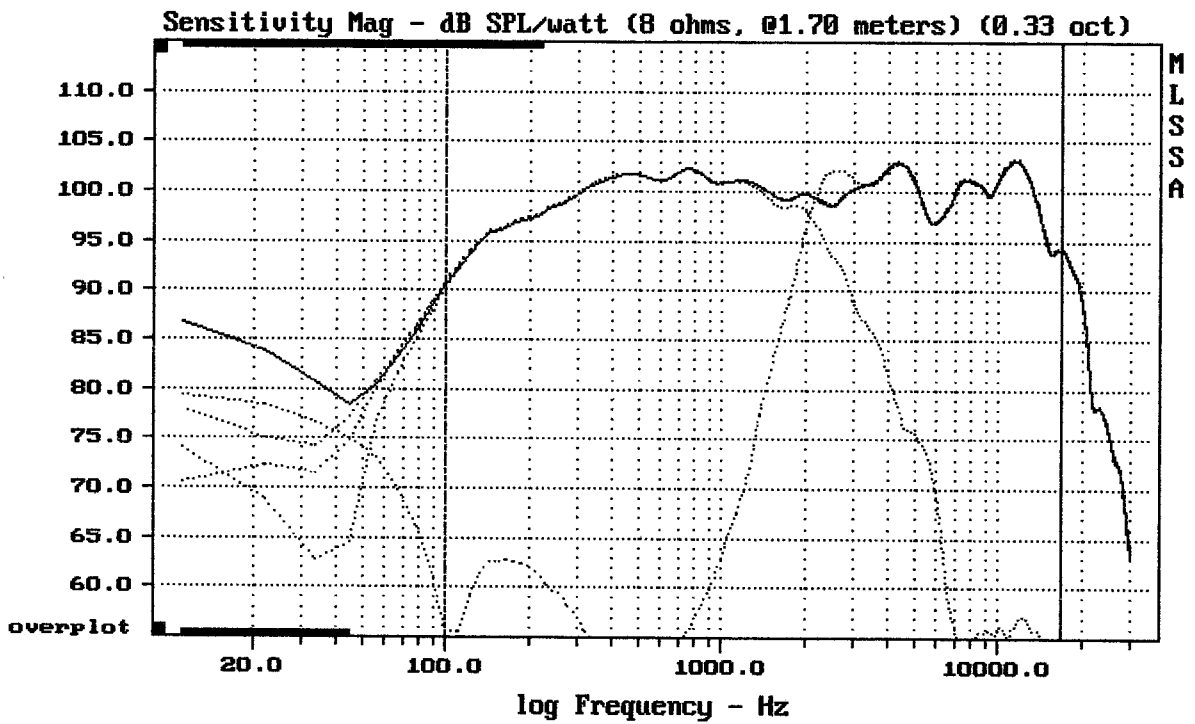

Level (100:17001 Hz) = 100.09 dB SPL/watt (8 ohms, @1.70 meters) (0.33 oct)

12MH32 + CD150 + A9090t

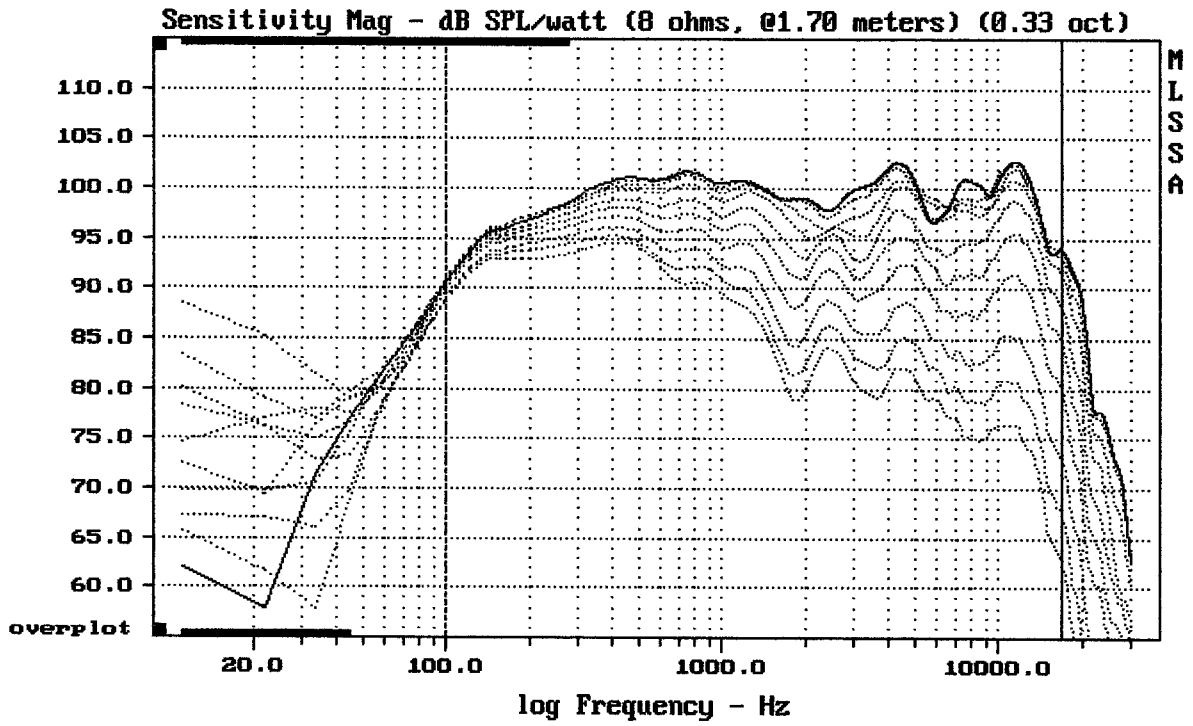

Overlay Compare: dev= +21/-8.8, std= 5.7, avg= -23

12MH32 + CD150 + A9090t

MLSSA: Frequency Domain

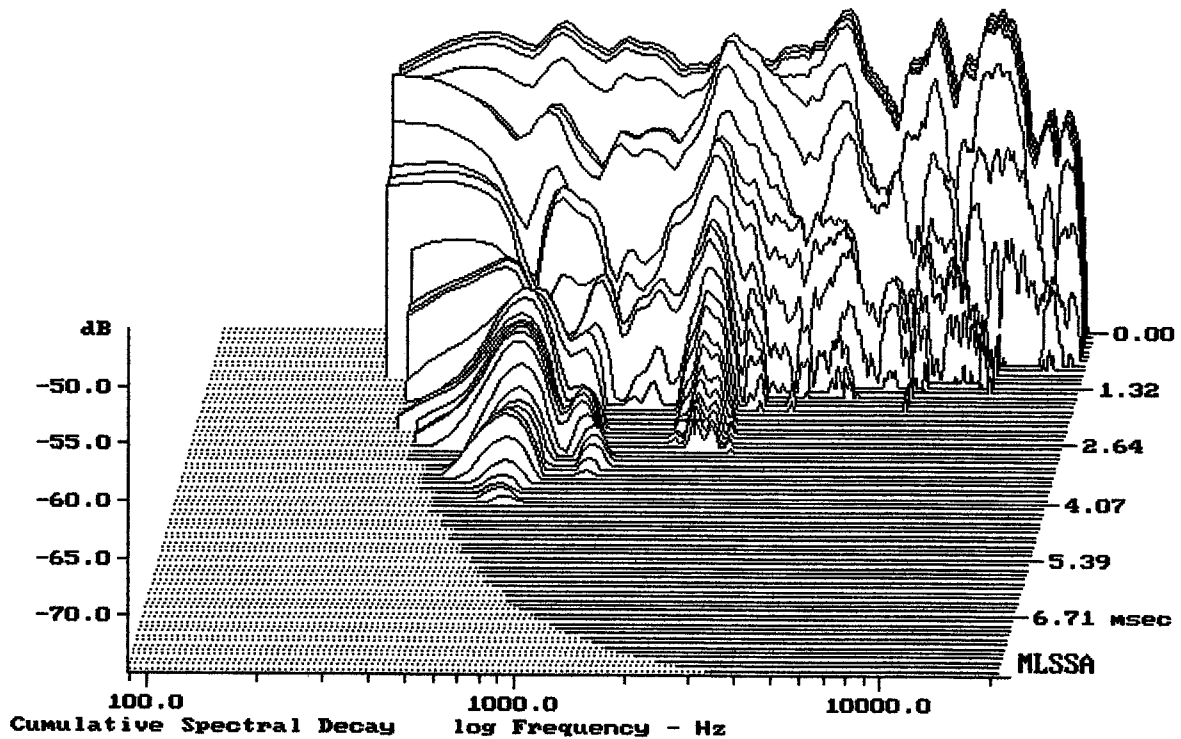

-72.59 dB, 2086 Hz (47), 2.750 msec (26)

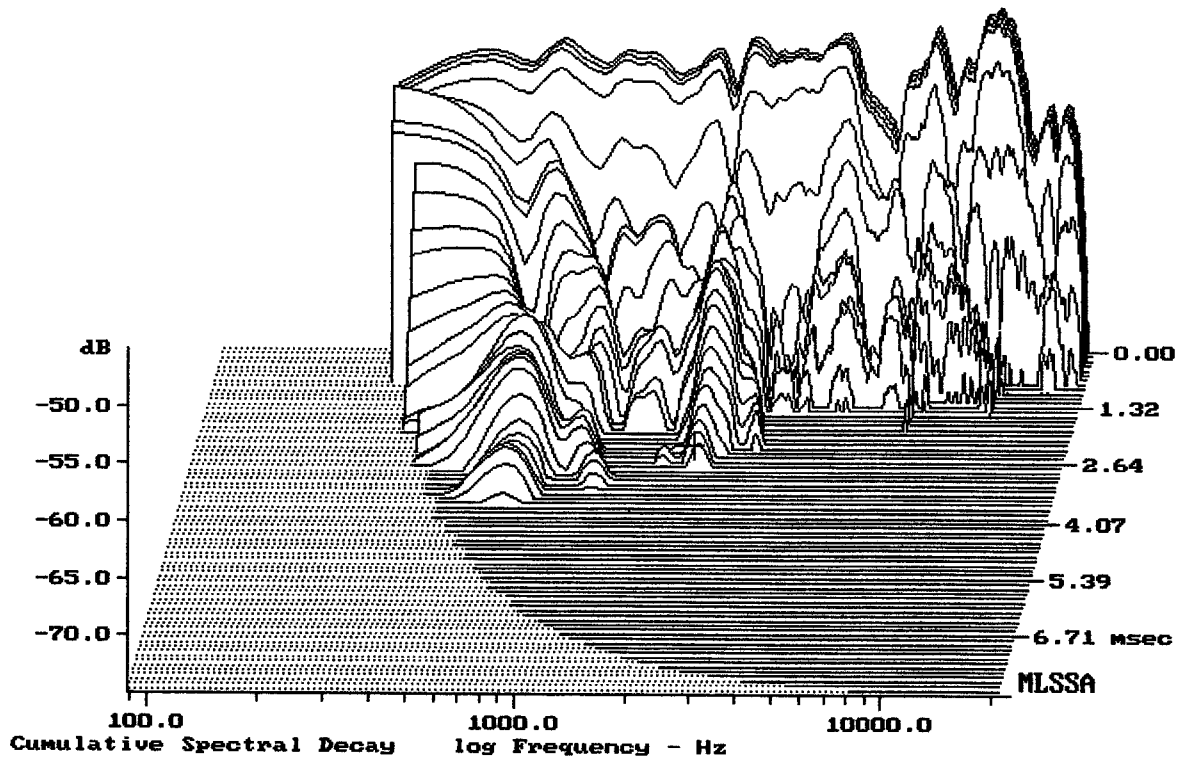

-73.12 dB, 2086 Hz (47), 2.750 msec (26)

DTTO

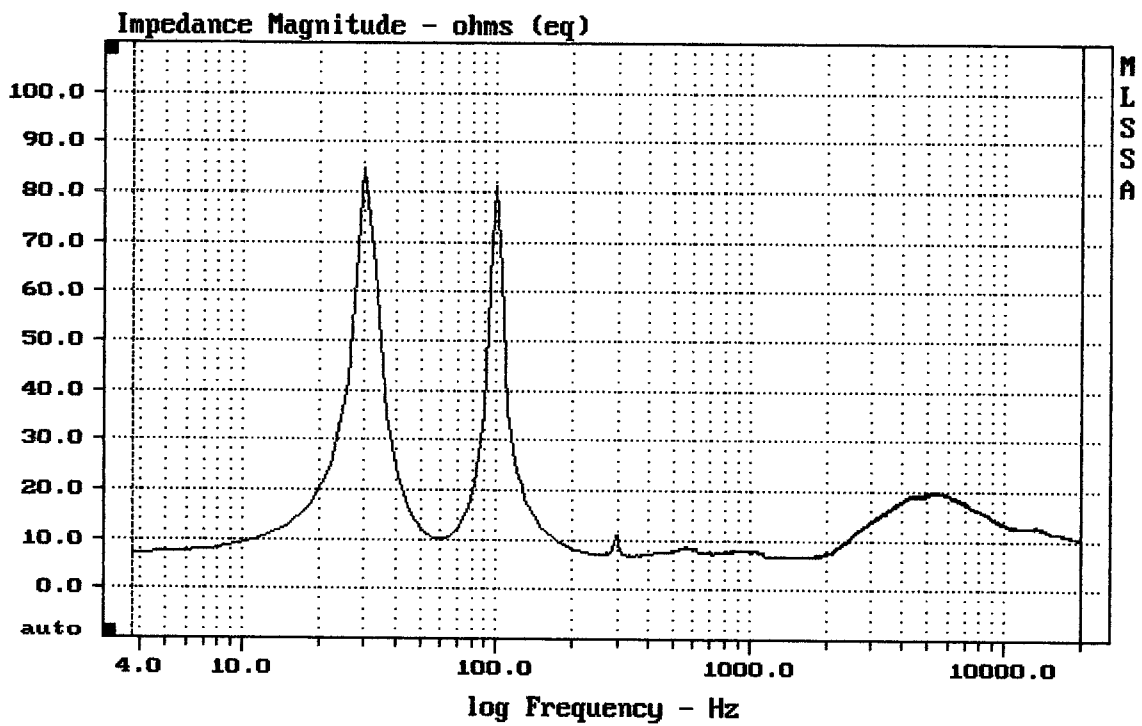

mean: 13.26, rms: 13.85, std: 4.015, max: 84.63, min: 6.565

12MH32 + CD150 + A9090t