

## Sestava B&C Speakers 15HPL76W + DE200 + Megaton A7570

### Osazení:

- B&C Speakers 15HPL76W 8/Ohm  
<http://eshop.prodance.cz/DetailPage.asp?DPG=82848>
- B&C Speakers DE200 8/Ohm  
<http://eshop.prodance.cz/DetailPage.asp?DPG=82302>
- Megaton A7570  
<http://eshop.prodance.cz/DetailPage.asp?DPG=83912>

### Schéma výhybky:

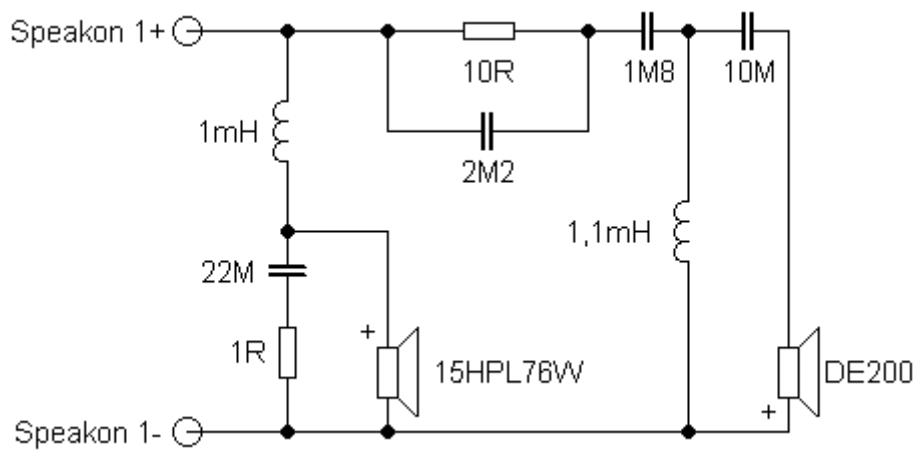

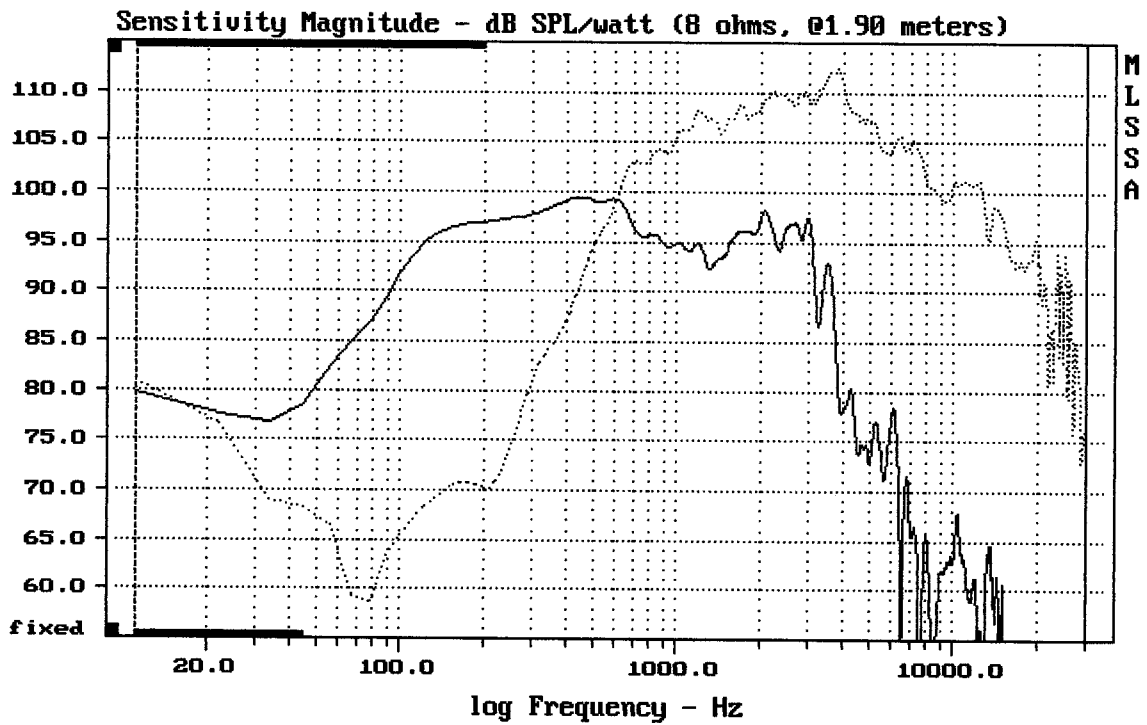

CURSOR: dy = 44.1969 x = 30007.1014 (2704)

15HPL76W + DE200 + A7570

MLSSA: Frequency Domain

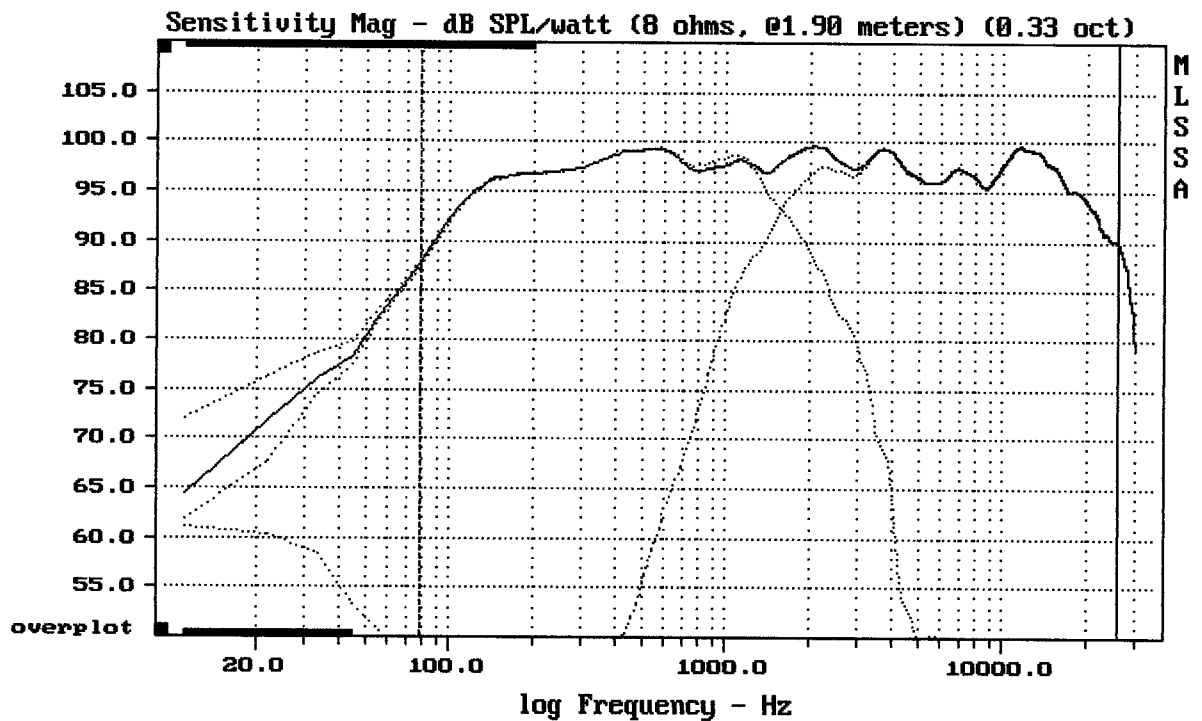

Level (78:26001 Hz) = 97.33 dB SPL/watt (8 ohms, @1.90 meters) (0.33 oct)

15HPL76W + DE200 + A7570

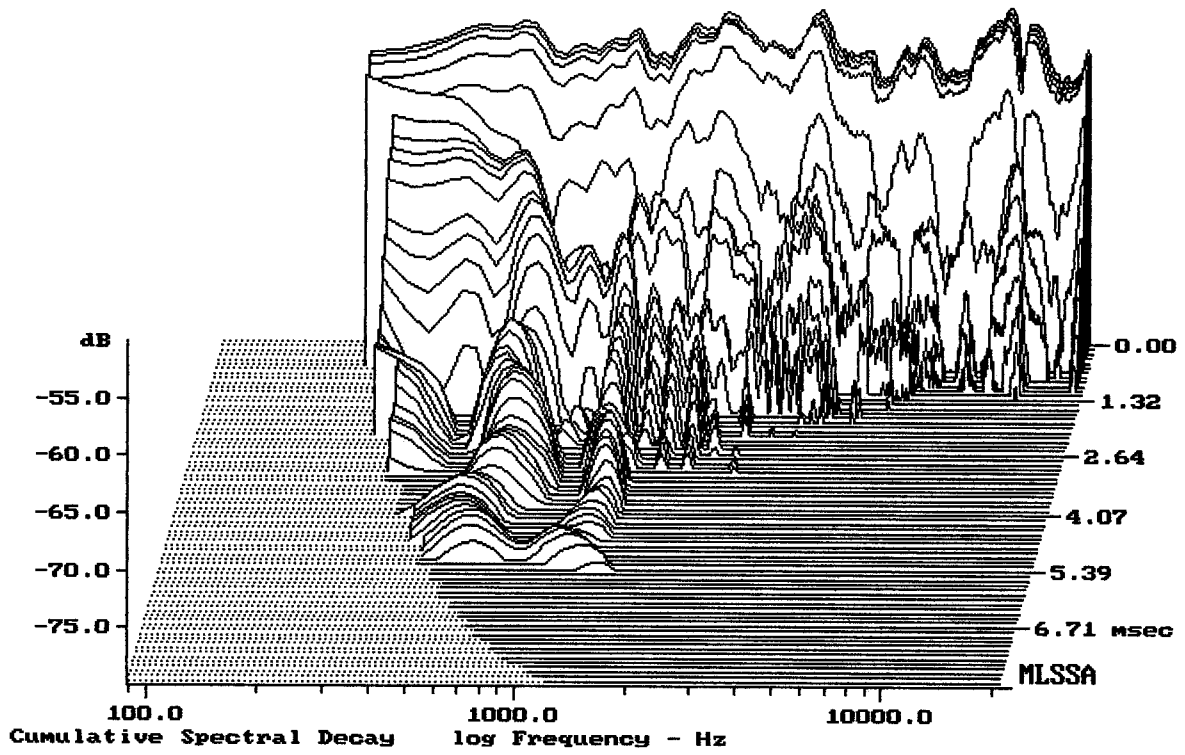

-78.27 dB, 1687 Hz (38), 2.860 msec (27)

DTTO

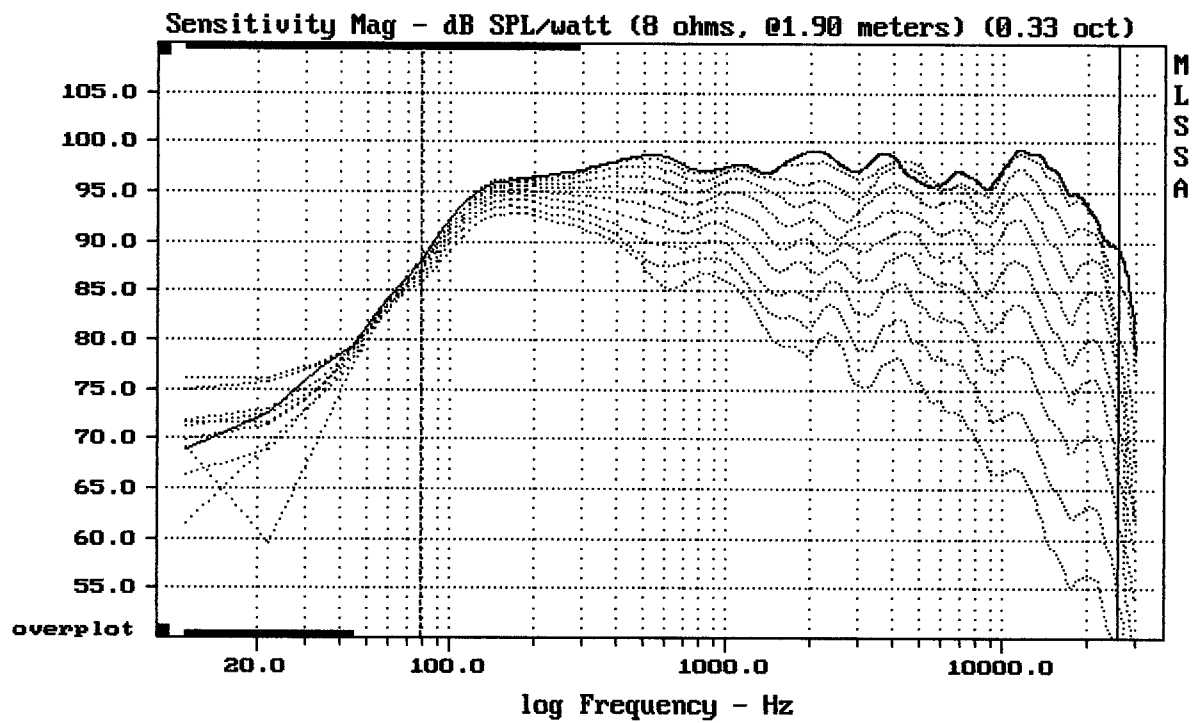

Overlay Compare: dev= +29/-12, std= 8.6, avg= -31

15HPL76W + DE200 + A7570

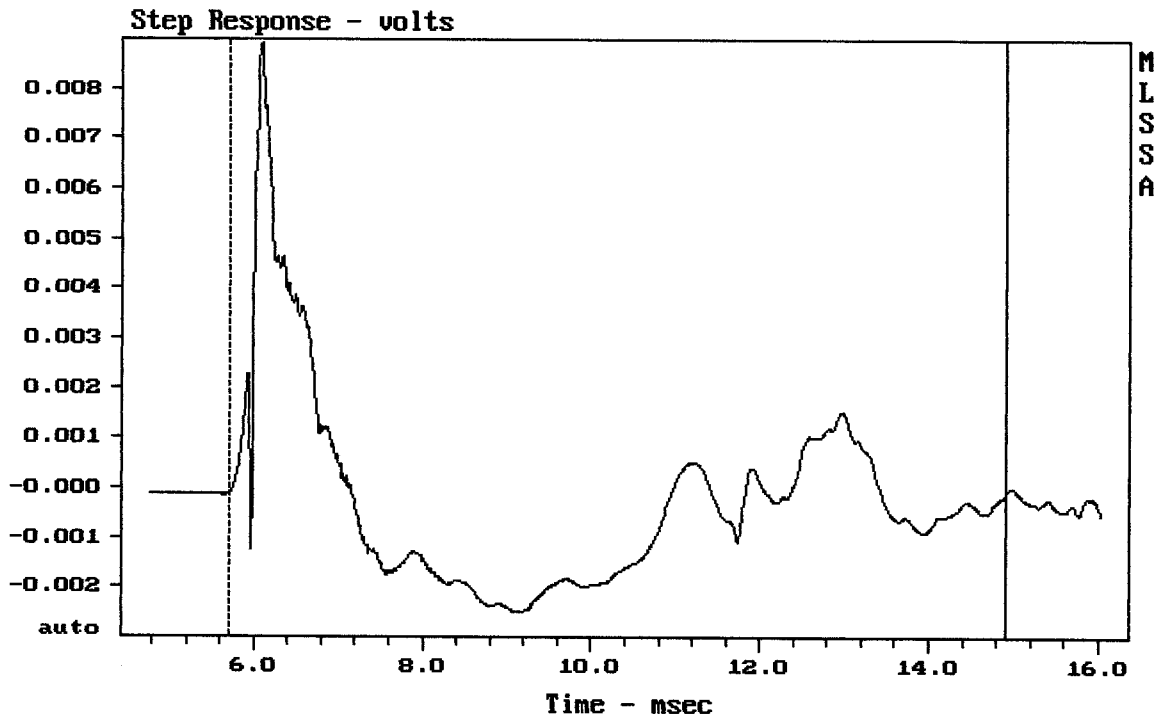



---

mean: -0.000269, rms: 0.001936, std: 0.001917, max: 0.008914, min: -0.002511

---

15HPL76W + DE200 + A7570

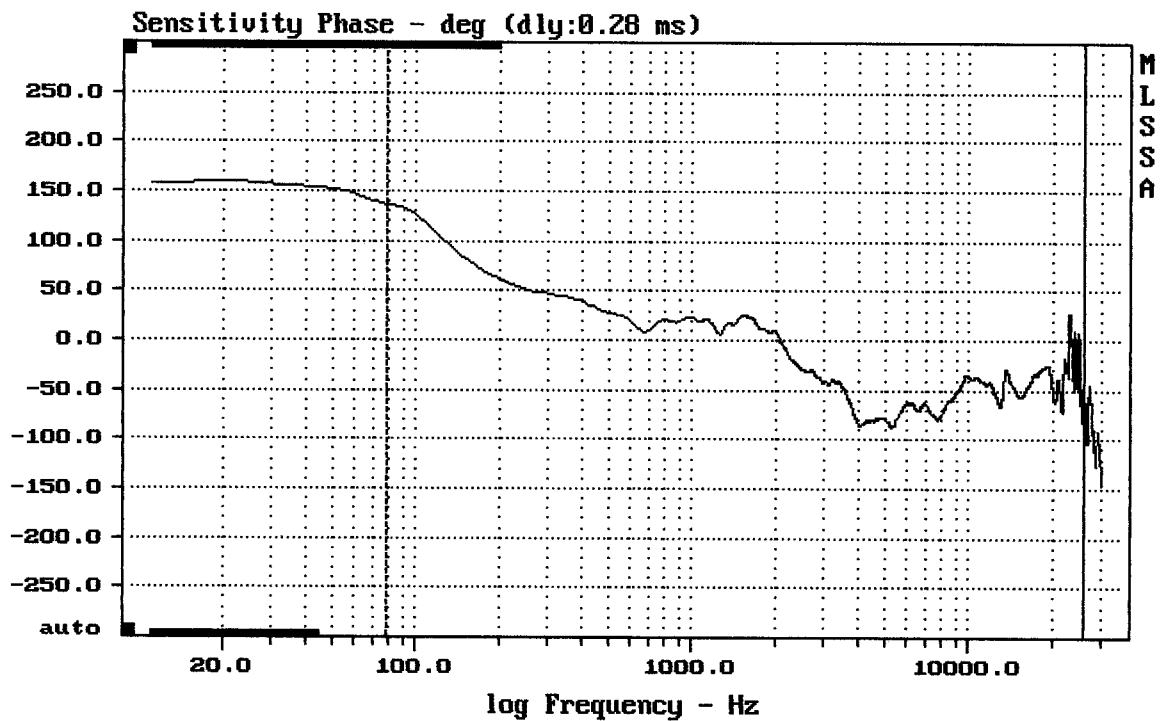
MLSSA: Time Domain





---

mean: -40.5, rms: 49.59, std: 28.61, max: 137.3, min: -87.49

---

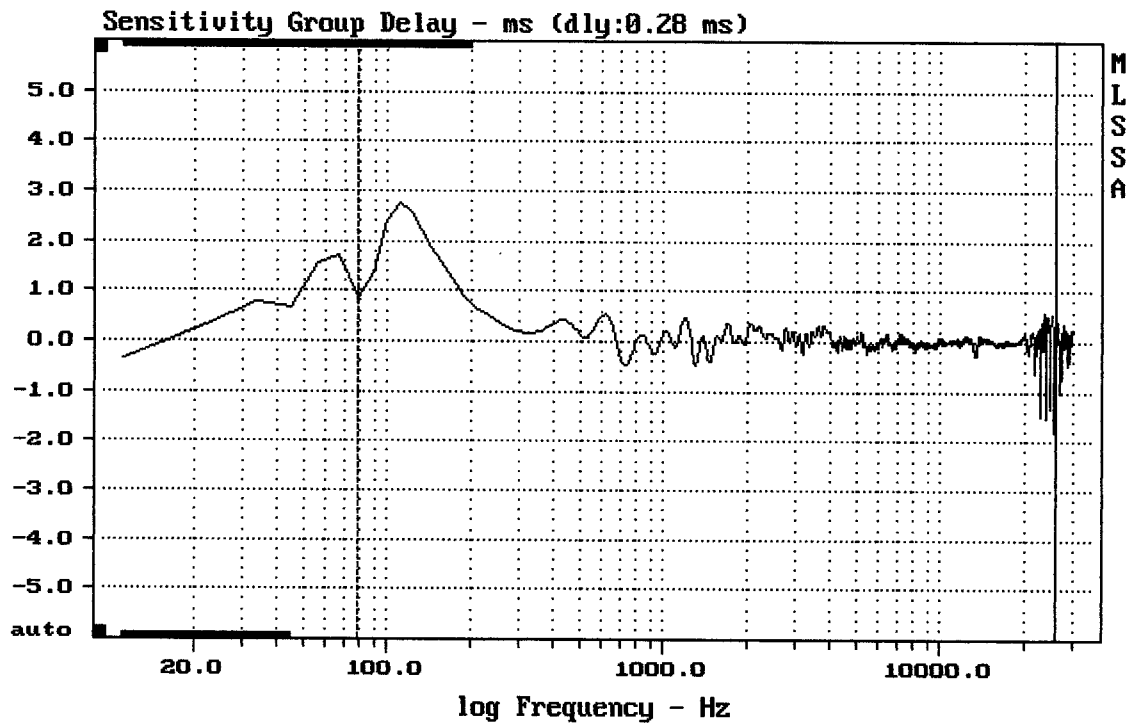
15HPL76W + DE200 + A7570





---

mean: 0.01795, rms: 0.2655, std: 0.2649, max: 2.772, min: -1.817

---

15HPL76W + DE200 + A7570

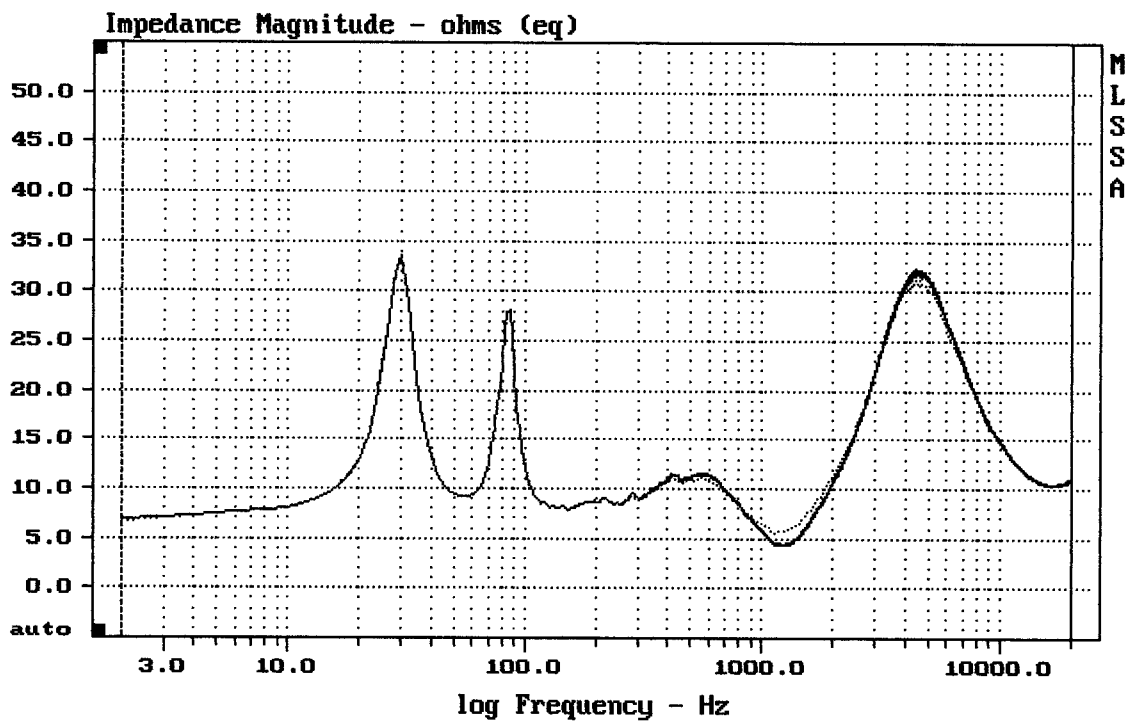
MLSSA: Frequency Domain



---

mean: 15.59, rms: 17.05, std: 6.911, max: 33.4, min: 5.599

---

15HPL76W + DE200 + A7570