

Sestava B&C Speakers 15NDL76 + DE250 + Megaton A6560

Osazení:

- B&C Speakers 15NDL76 8/Ohm
<http://eshop.prodance.cz/DetailPage.asp?DPG=82860>
- B&C Speakers DE250 8/Ohm
<http://eshop.prodance.cz/DetailPage.asp?DPG=82306>
- Megaton A6560
<http://eshop.prodance.cz/DetailPage.asp?DPG=83901>

Schéma výhybky:

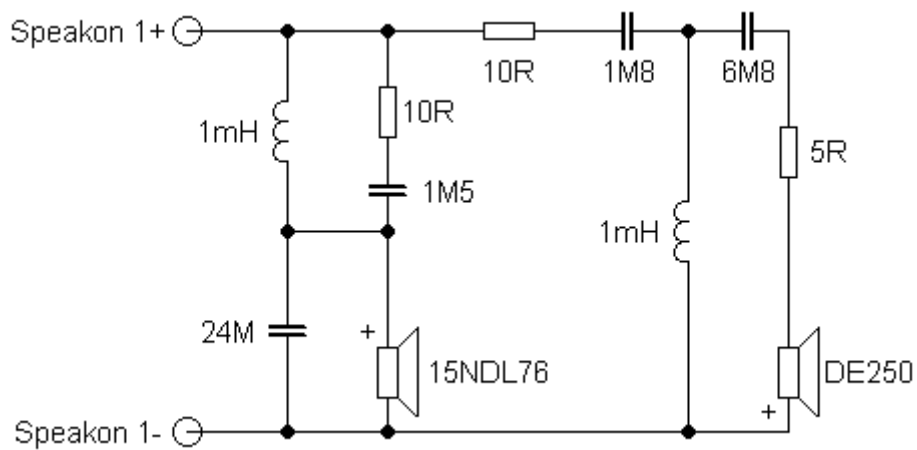

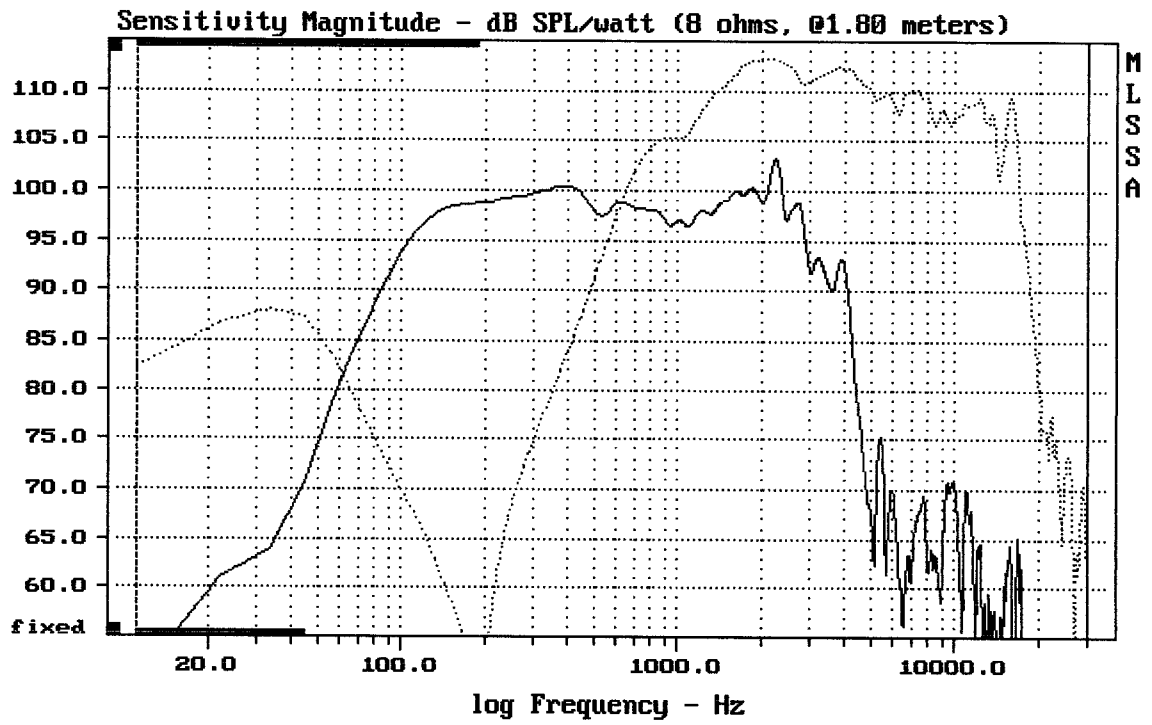

CURSOR: dy = 31.0035 x = 30007.1014 (2704)

15NDL76 + DE250 + A6560

MLSSA: Frequency Domain

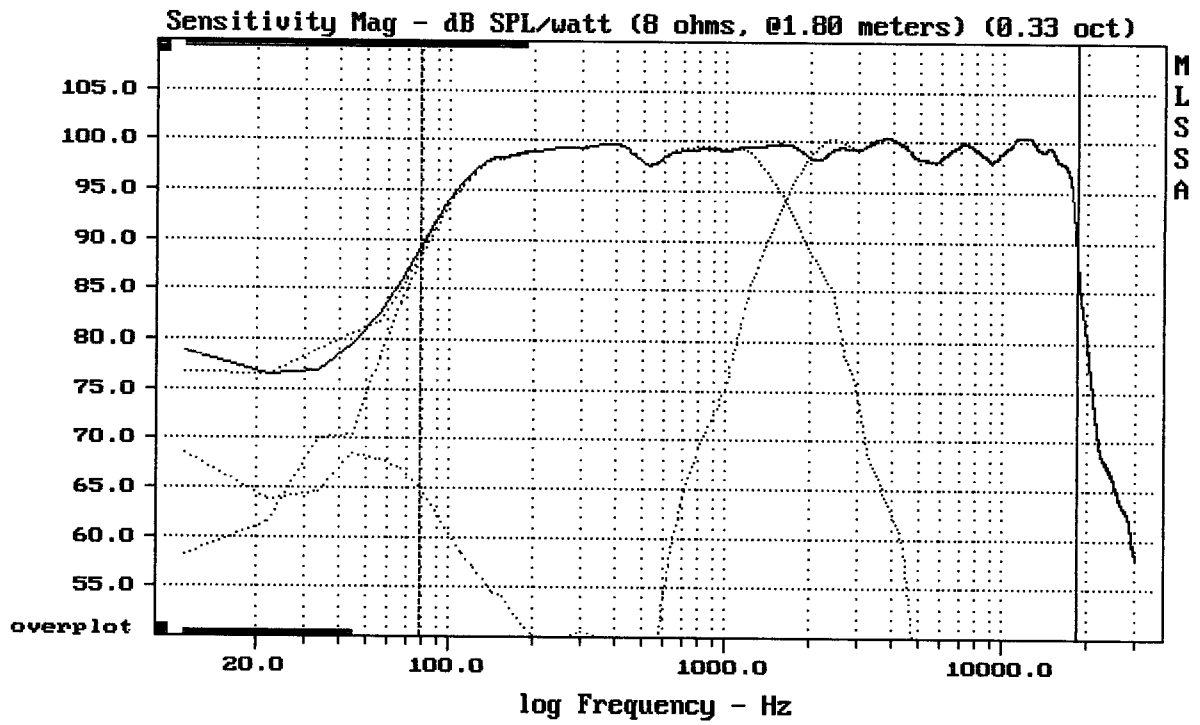

Level (78:18499 Hz) = 98.77 dB SPL/watt (8 ohms, @1.80 meters) (0.33 oct)

15NDL76 + DE250 + A6560

MLSSA: Frequency Domain

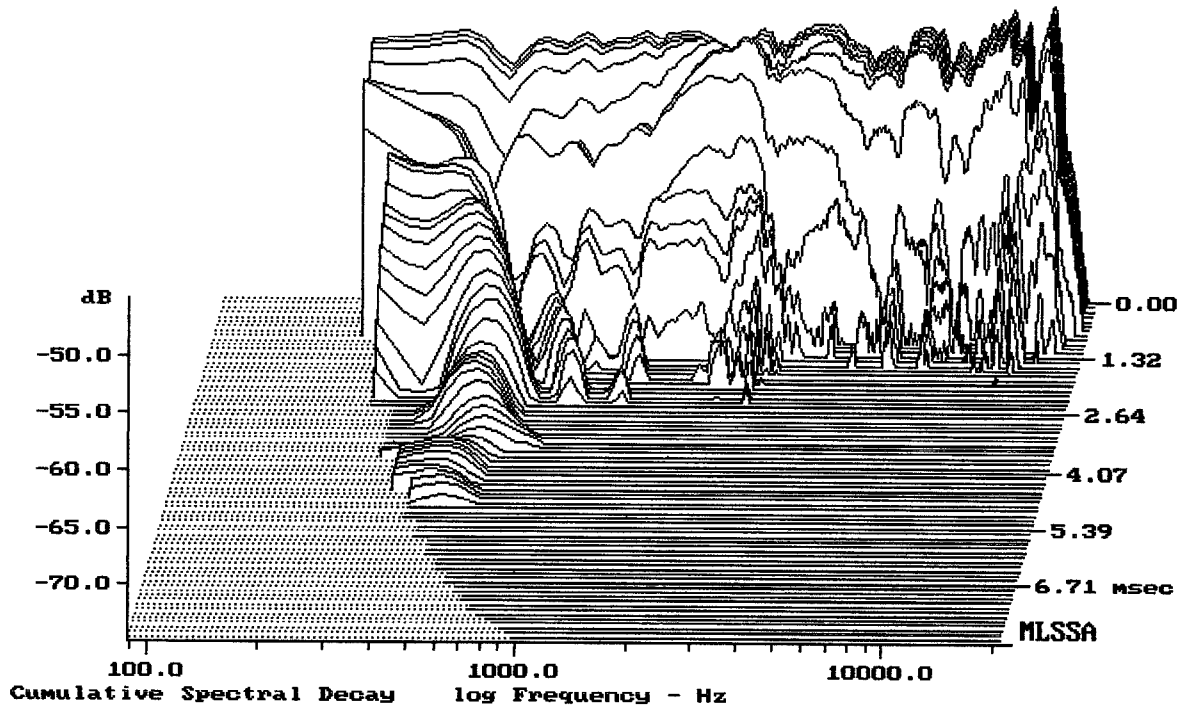

-71.25 dB, 2300 Hz (52), 1.980 msec (19)

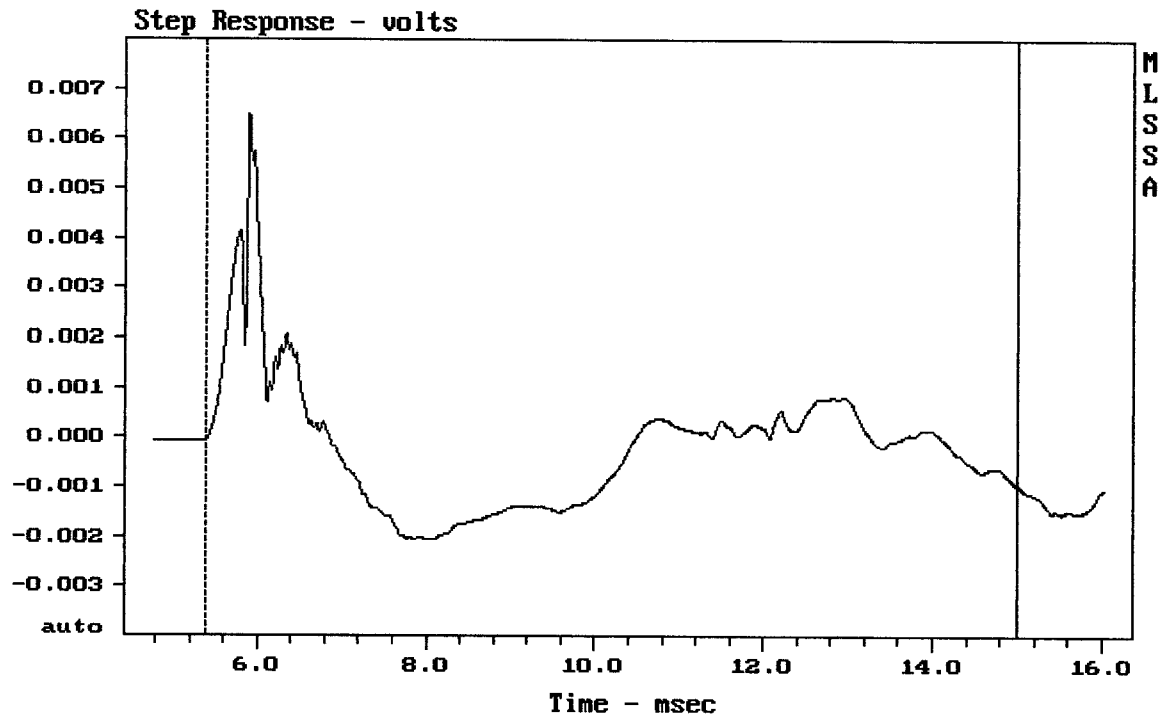

mean: -0.0001909, rms: 0.001331, std: 0.001317, max: 0.006491, min: -0.002059

15NDL76 + DE250 + A6560

MLSSA: Time Domain

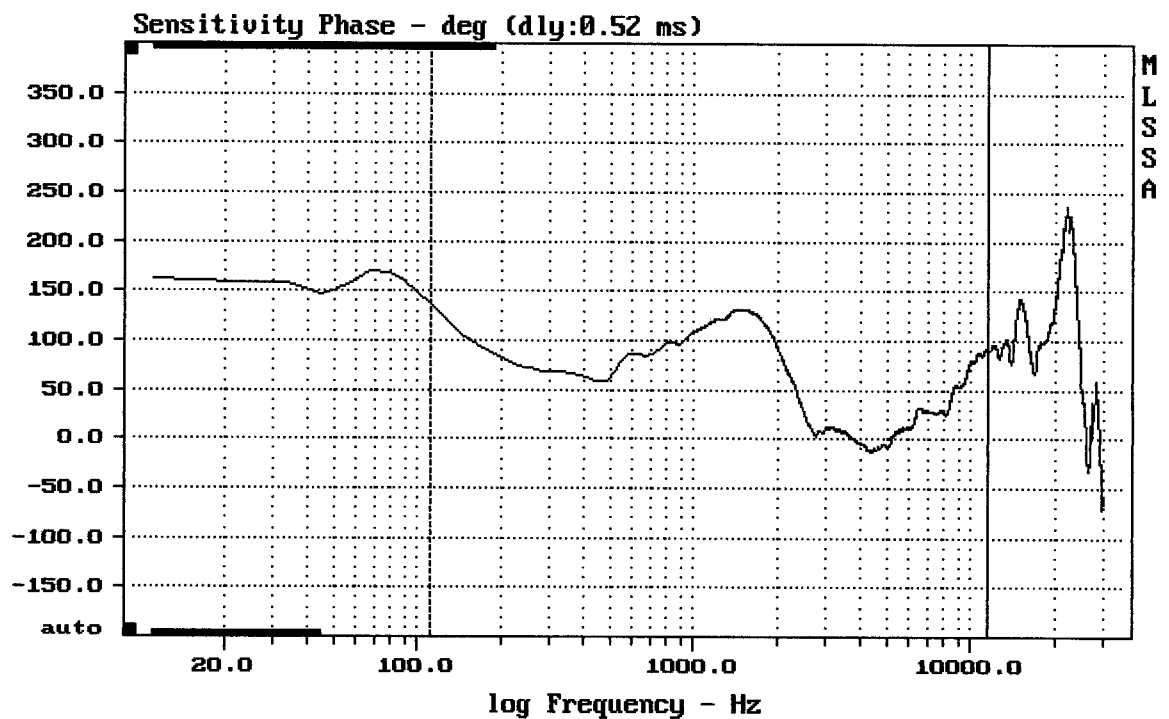

mean: 45.53, rms: 60.5, std: 39.84, max: 136.6, min: -13.62

15NDL76 + DE250 + A6560

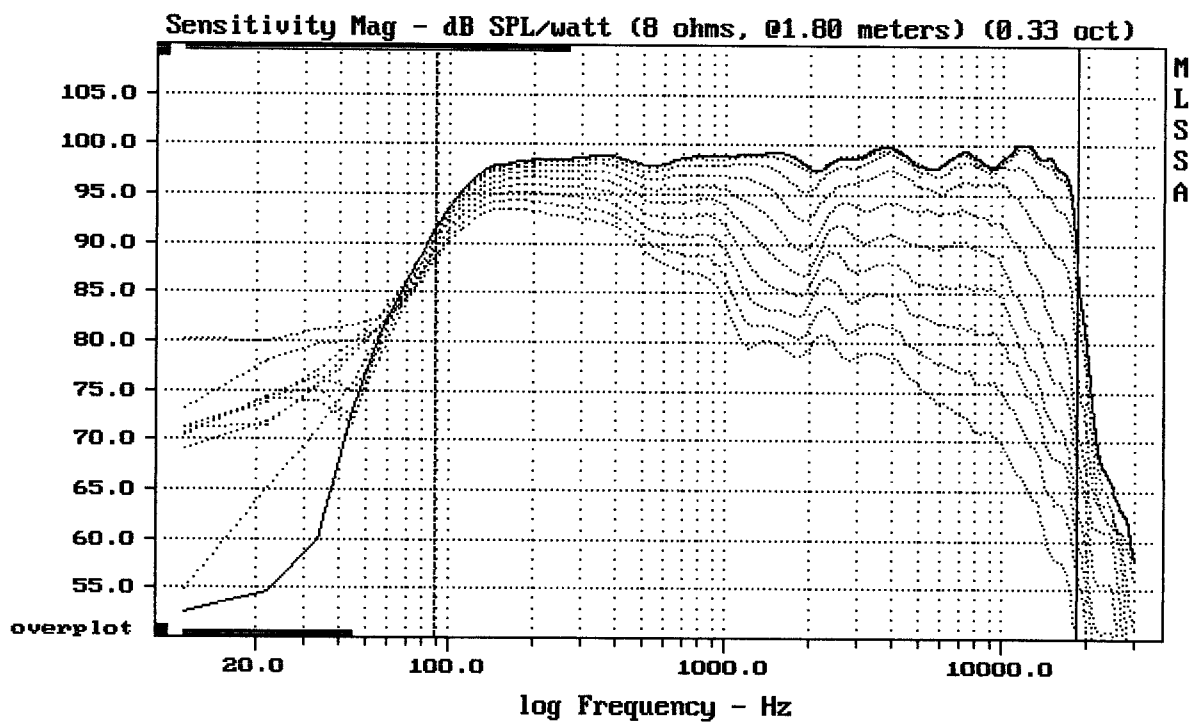

Overlay Compare: dev= +26/-12, std= 8.7, avg= -29

15NDL76 + DE250 + A6560

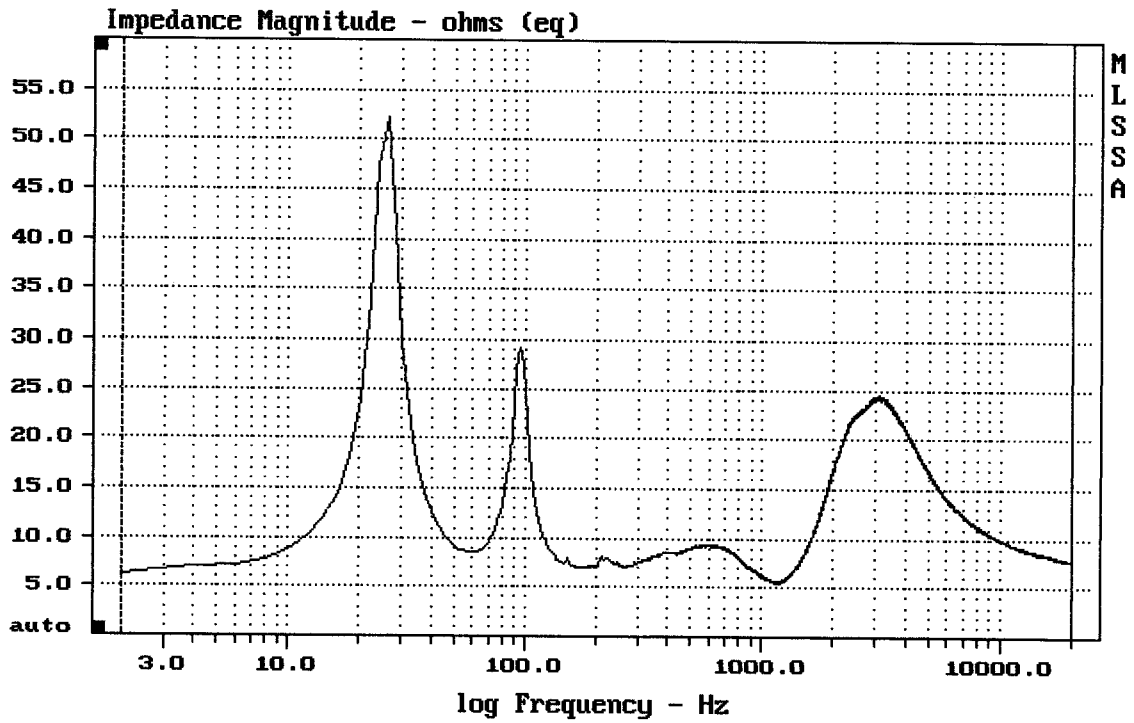

mean: 11.45, rms: 12.4, std: 4.76, max: 52.12, min: 5.472

15NDL76 + DE250 + A6560

MLSSA: Frequency Domain

