

Sestava B&C Speakers 15PWB40 + DE72 + ME90

Osazení:

- B&C Speakers 15PWB40 8/Ohm
<http://eshop.prodance.cz/DetailPage.asp?DPG=82917>
- B&C Speakers DE72 8/Ohm
<http://eshop.prodance.cz/DetailPage.asp?DPG=82321>
- B&C Speakers ME90
<http://eshop.prodance.cz/DetailPage.asp?DPG=80246>

Schéma výhybky:

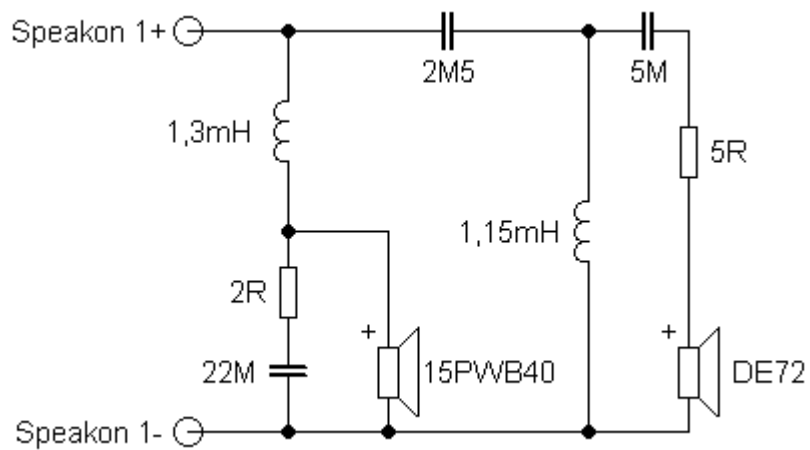

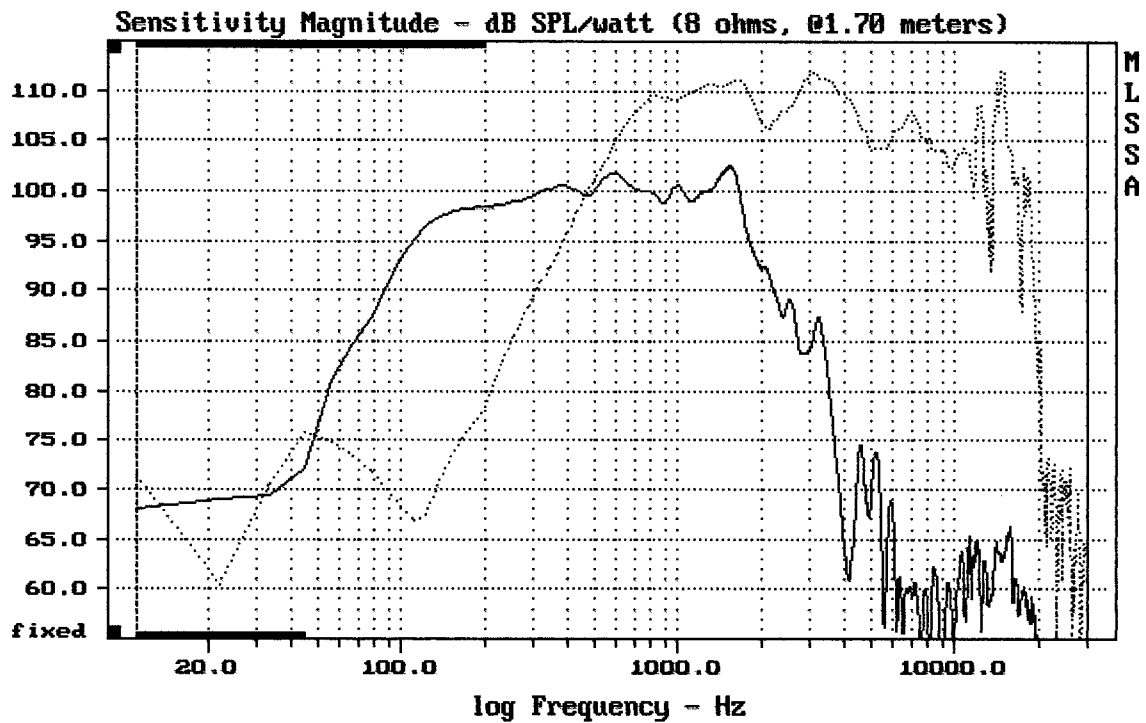

CURSOR: $dy = 27.6113$ $x = 30007.1014$ (2704)

15PWB40 + DE72 + ME90

MLSSA: Frequency Domain

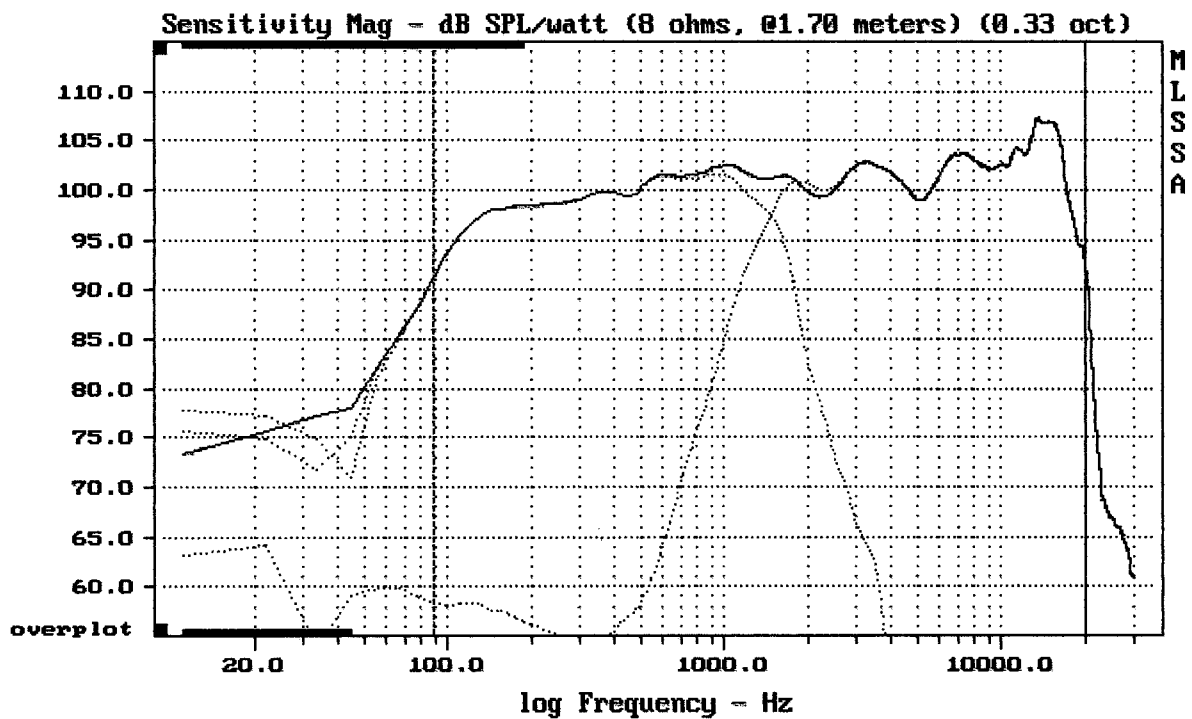

Level (89:20008 Hz) = 101.32 dB SPL/watt (8 ohms, @1.70 meters) (0.33 oct)

15PWB40 + DE72 + ME90

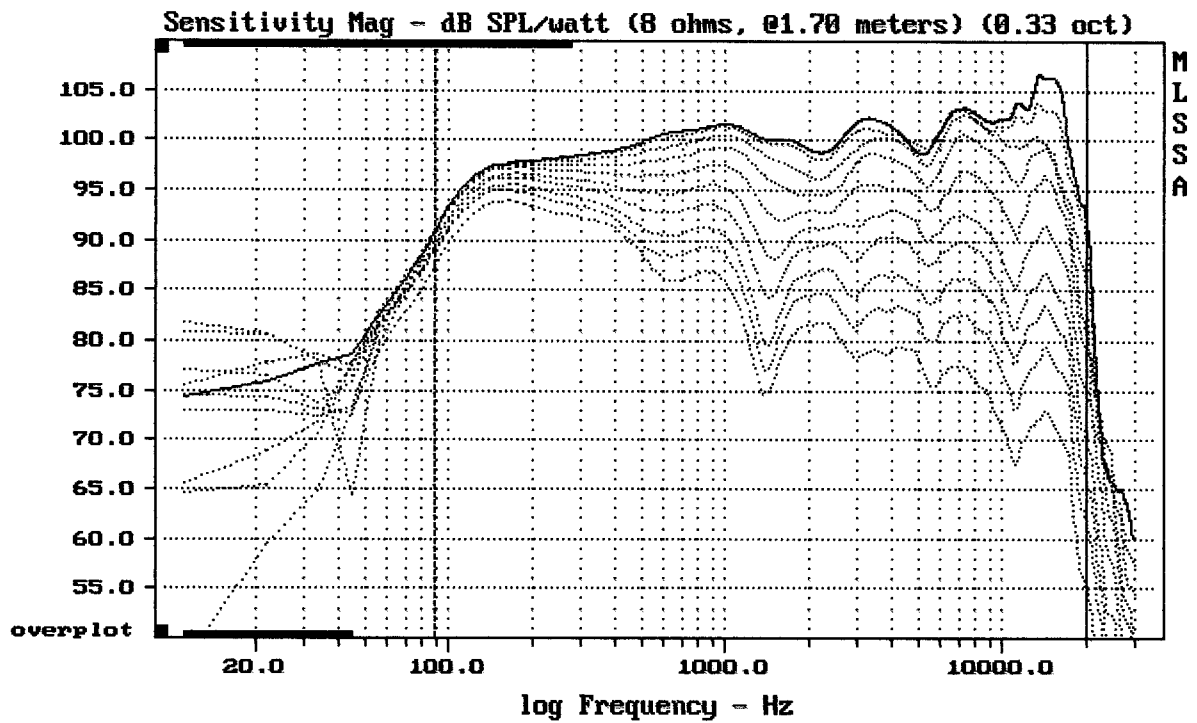

Overlay Compare: dev= +25/-9.1, std= 6.9, avg= -28

15PWB40 + DE72 + ME90

MLSSA: Frequency Domain

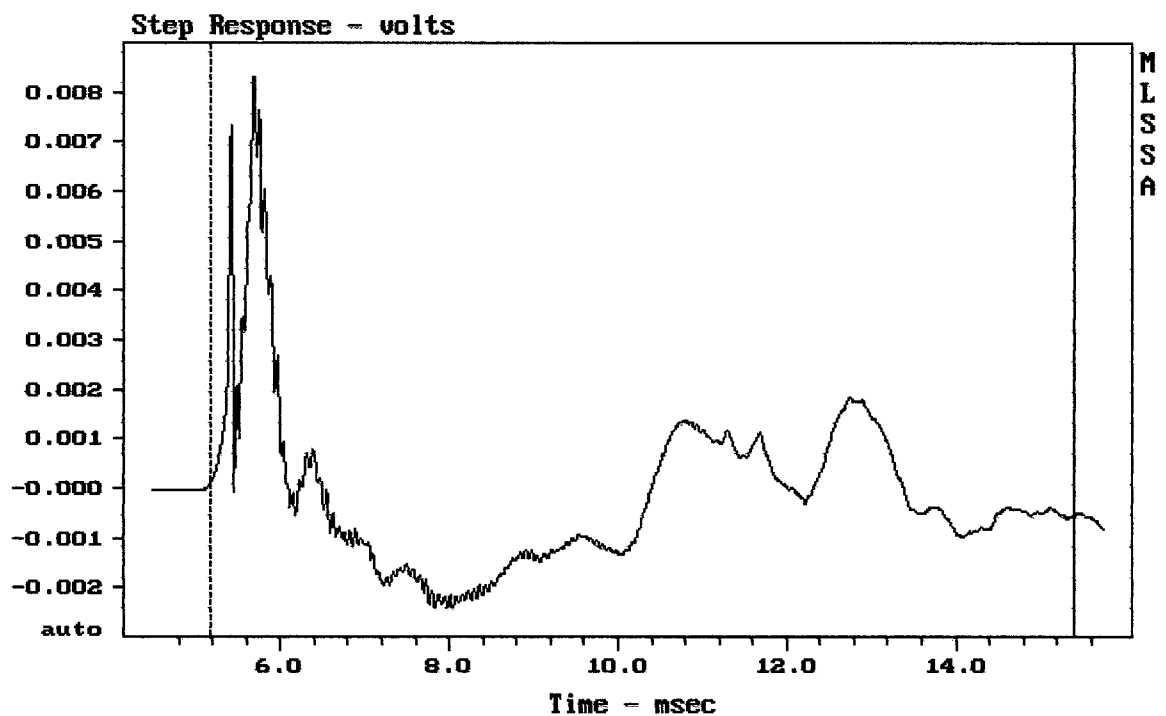

mean: -0.0001299, rms: 0.001648, std: 0.001643, max: 0.008309, min: -0.002423

15PWB40 + DE72 + ME90

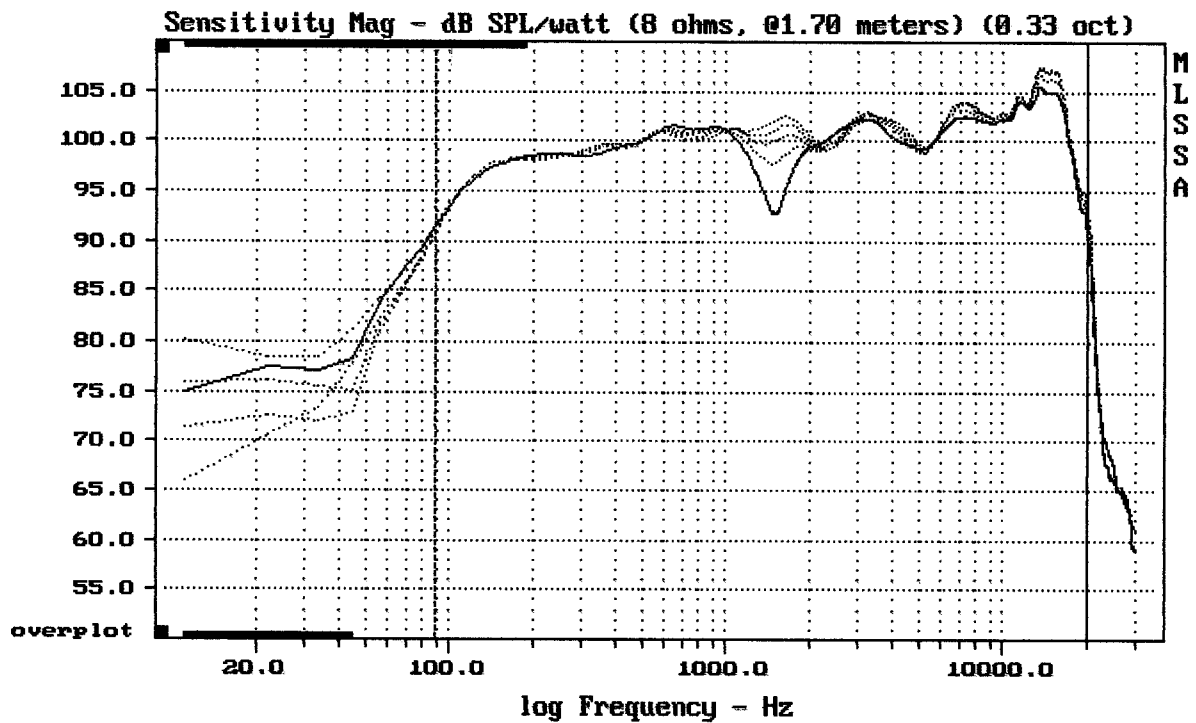

mean: 102.85, rms: 103.35, std: 2.61, max: 107.49, min: 91.03

15PWB40 + DE72 + ME90

MLSSA: Frequency Domain

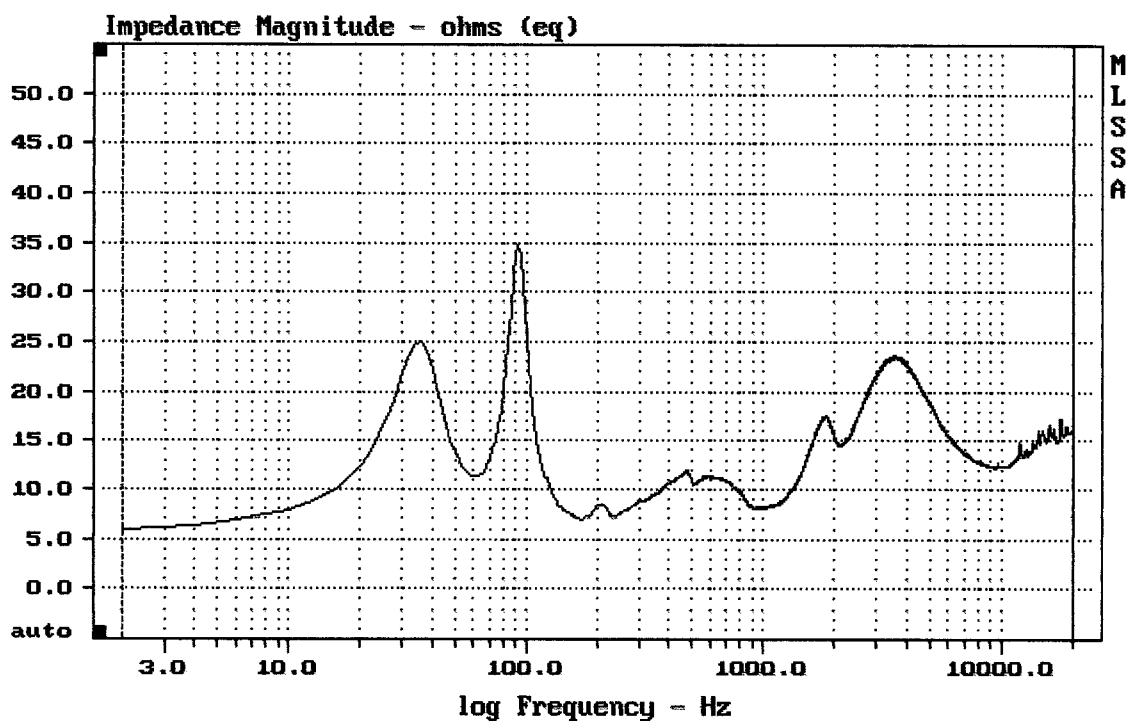

mean: 15.08, rms: 15.41, std: 3.17, max: 34.8, min: 5.864

15PWB40 + DE72 + ME90