

Sestava Fane Colossus 12MB + BMS BMS4555 + Megaton B8575

Osazení:

- Fane Colossus 12MB 8/Ohm

<http://eshop.prodance.cz/DetailPage.asp?DPG=85020>

- BMS BMS4555 8/Ohm

<http://eshop.prodance.cz/DetailPage.asp?DPG=87228>

- Megaton B8575

<http://eshop.prodance.cz/DetailPage.asp?DPG=84261>

Schéma výhybky:

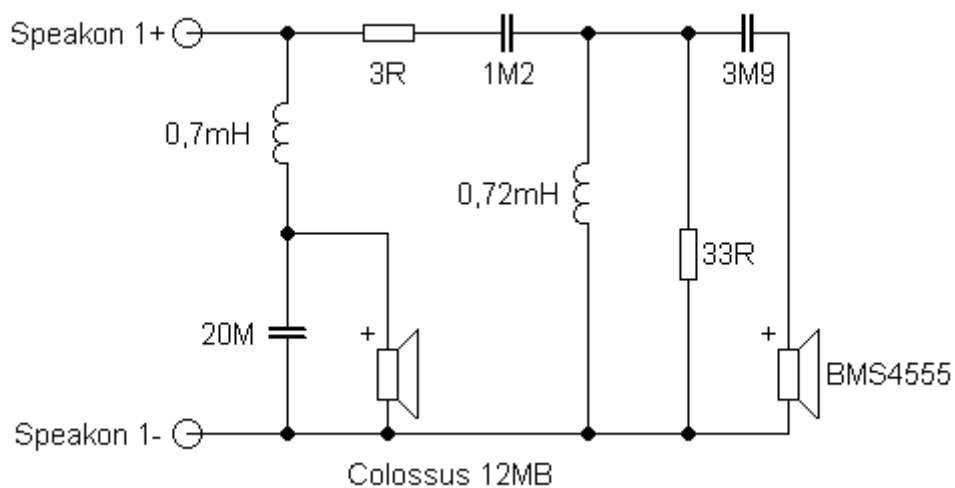

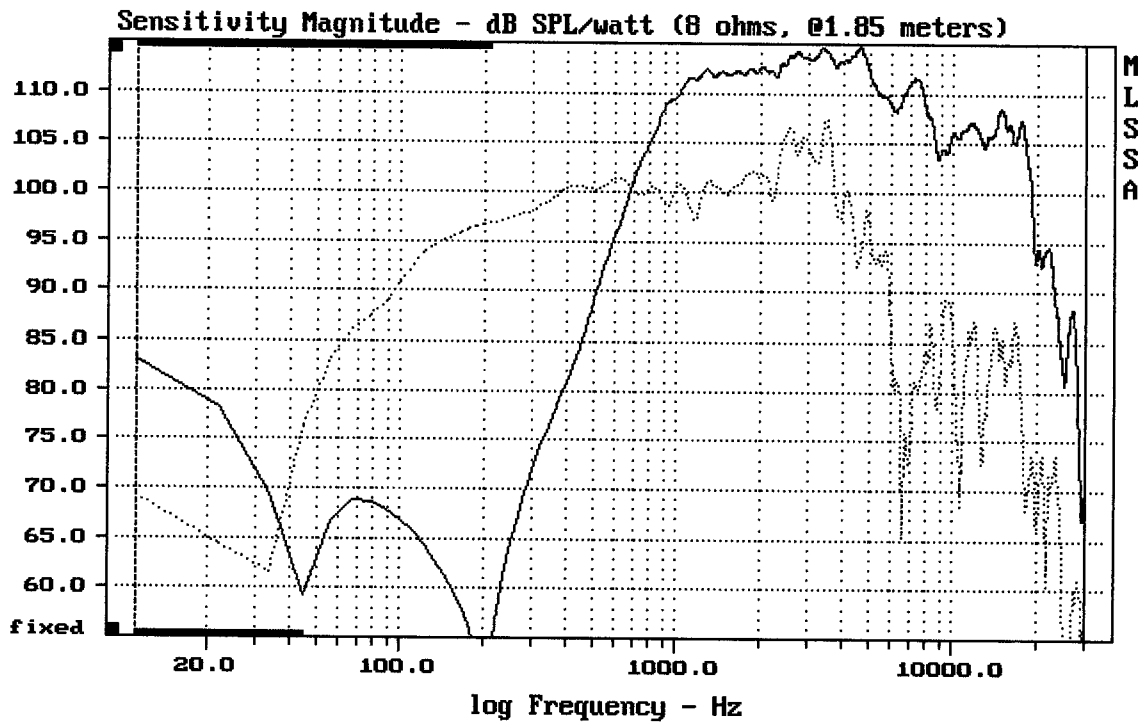

CURSOR: $dy = -12.5229$ $x = 30007.1014$ (2704)

COL12MB + BMS4555 + B8575

MLSSA: Frequency Domain

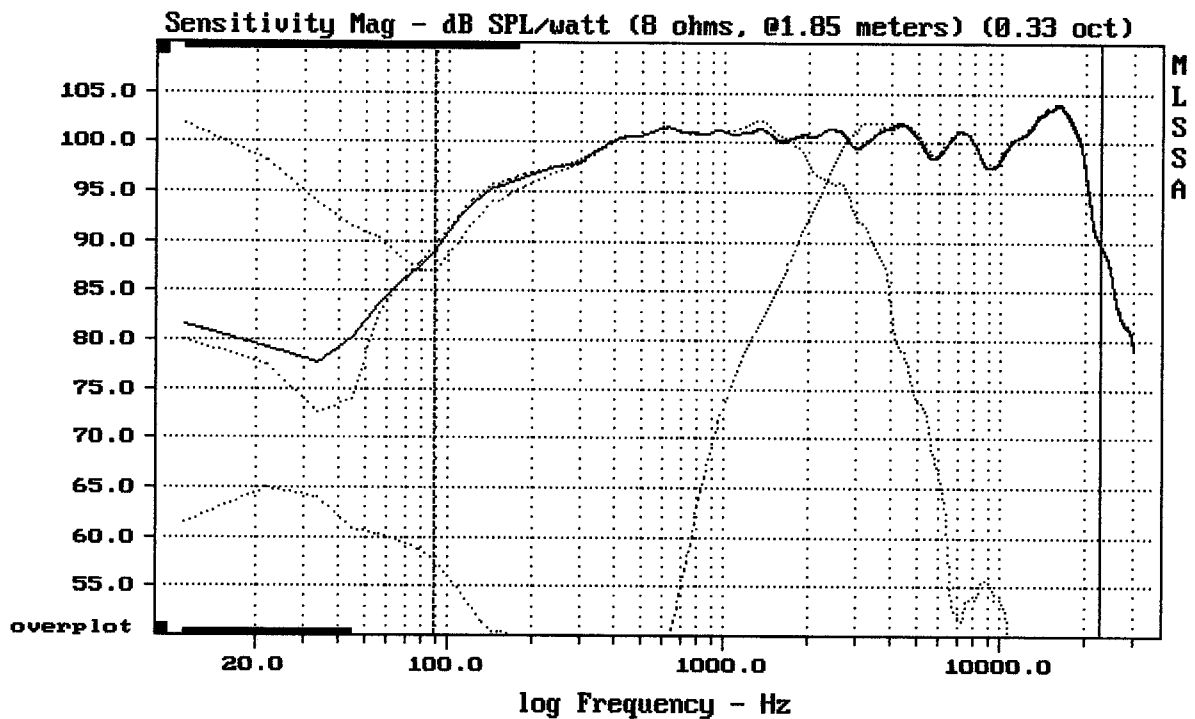

Level (89:23005 Hz) = 100.00 dB SPL/watt (8 ohms, @1.85 meters) (0.33 oct)

COL12MB + BMS4555 + B8575

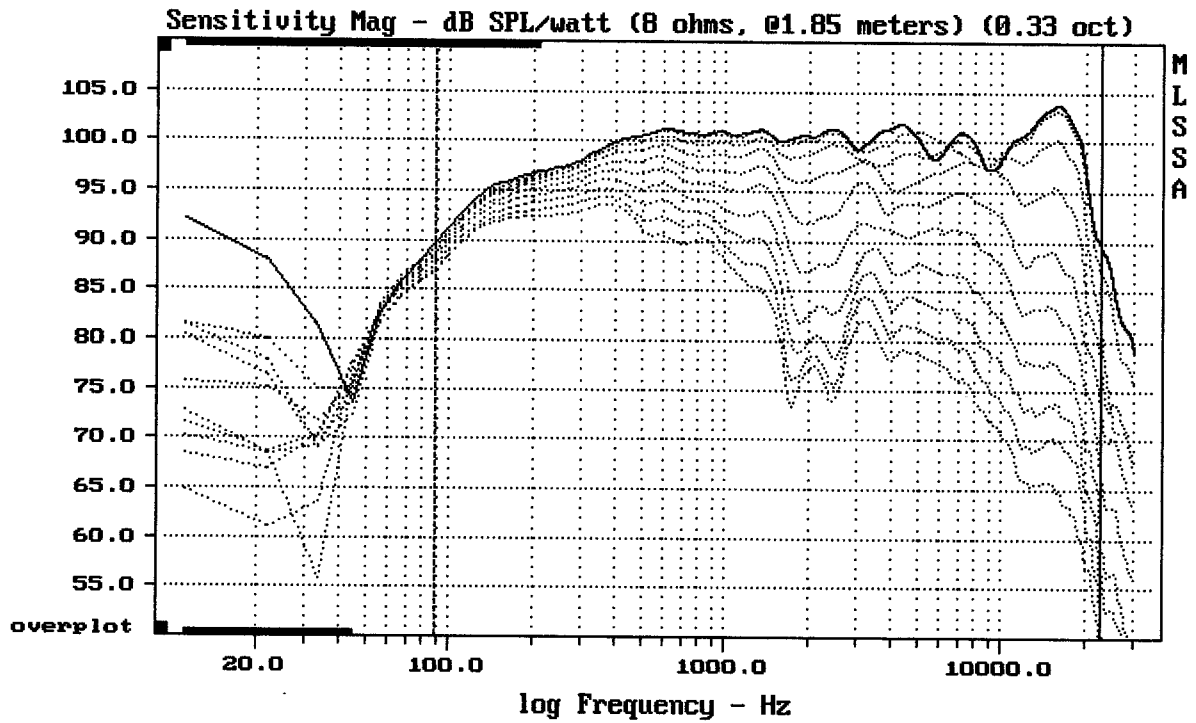

Overlay Compare: dev= +28/-11, std= 8.8, avg= -30

COL12MB + BMS4555 + B8575

MLSSA: Frequency Domain

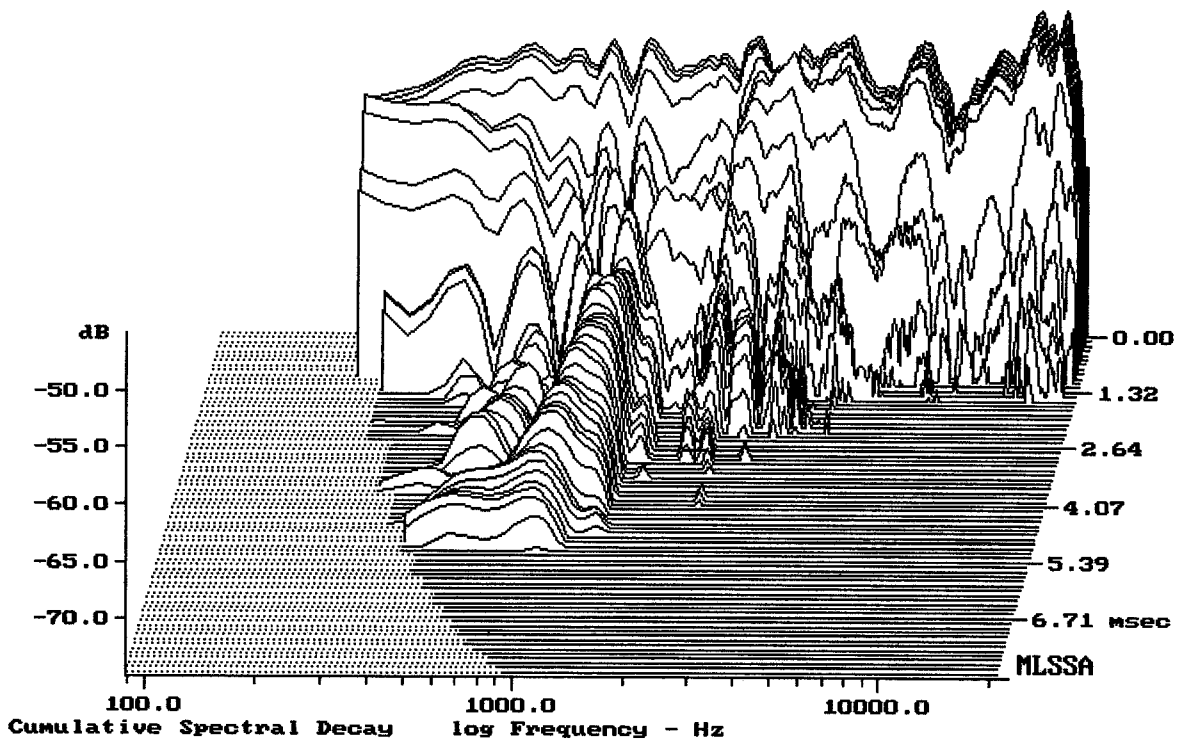

-74.63 dB, 2131 Hz (48), 2.860 msec (27)

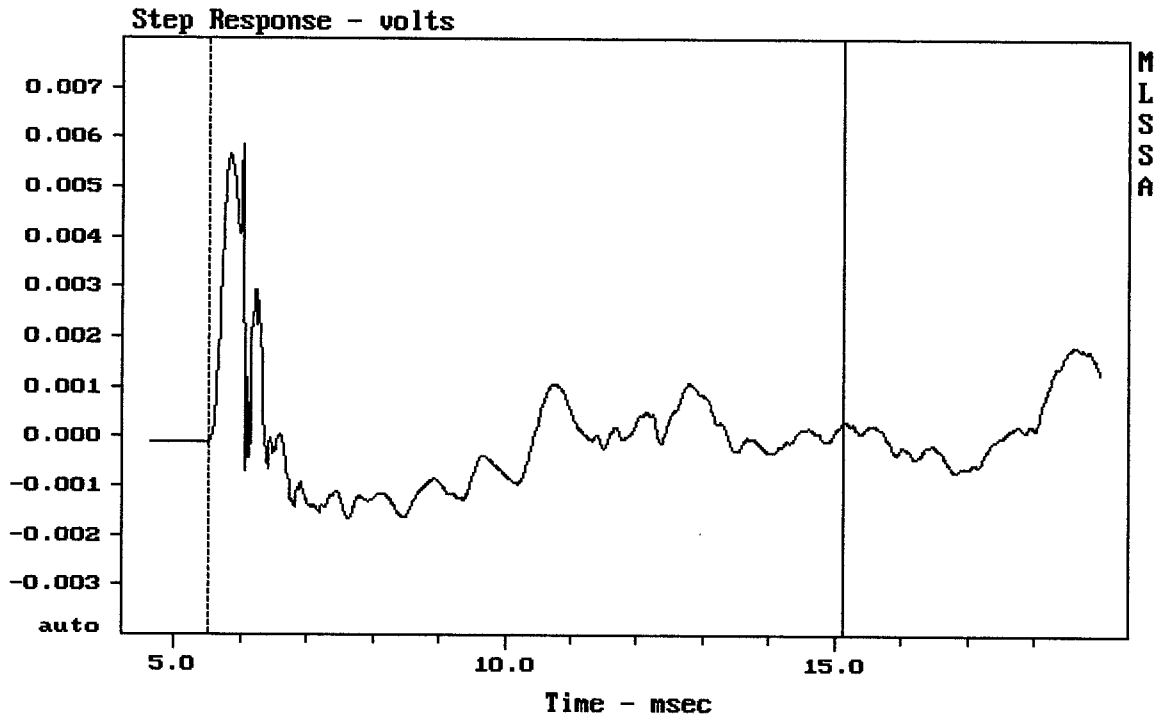

mean: $-6.875e-005$, rms: 0.001274, std: 0.001272, max: 0.005868, min: -0.00167

COL12MB + BMS4555 + B8575

MLSSA: Time Domain

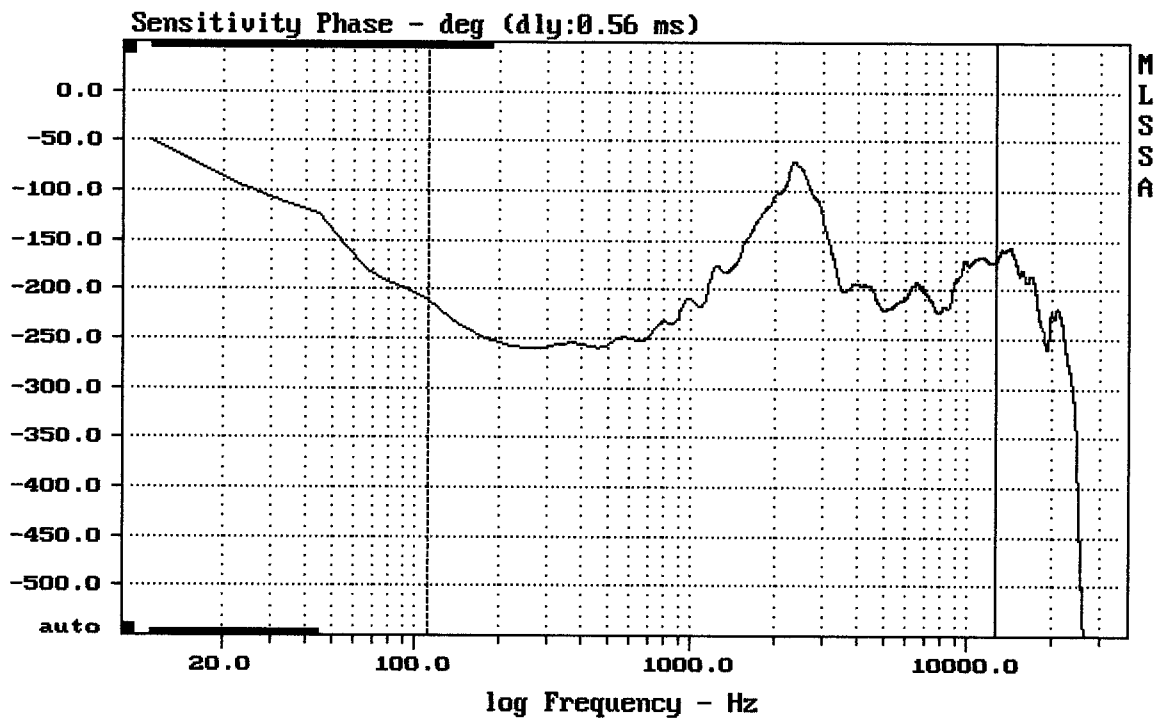

mean: -185.5, rms: 189.4, std: 38.05, max: -70.03, min: -259.6

COL12MB + BMS4555 + B8575

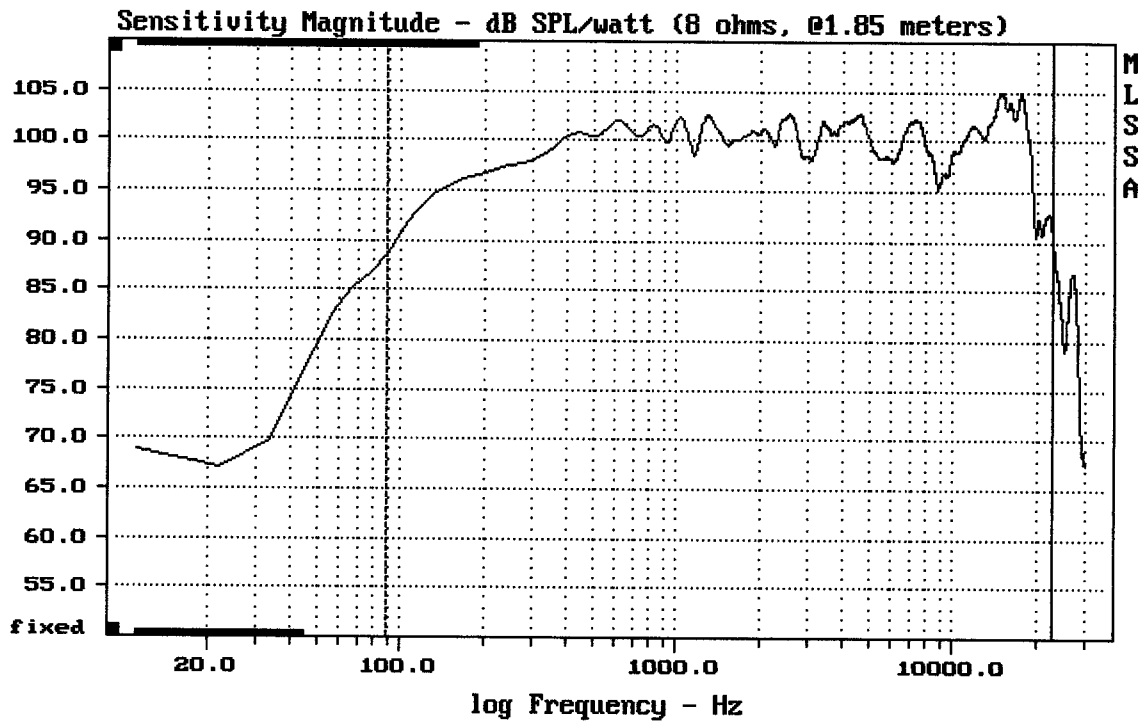

mean: 100.23, rms: 100.78, std: 2.70, max: 104.95, min: 88.53

COL12MB + BMS4555 + B8575

MLSSA: Frequency Domain

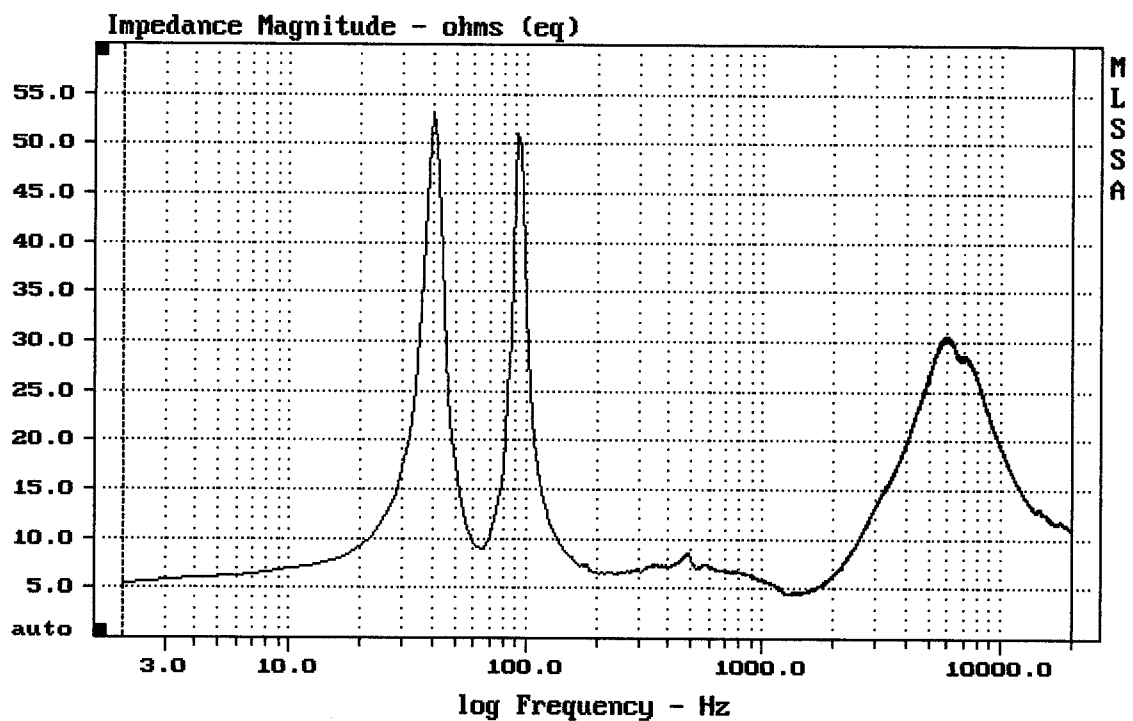

mean: 16.35, rms: 17.83, std: 7.097, max: 53.23, min: 4.389

COL12MB + BMS4555 + B8575