

Sestava RCF LF12G301 + B&C Speakers DE250 + Megaton A9090

Osazení:

- RCF LF12G301 8/Ohm

<http://eshop.prodance.cz/DetailPage.asp?DPG=80644>

- B&C Speakers DE250 8/Ohm

<http://eshop.prodance.cz/DetailPage.asp?DPG=82306>

- Megaton A9090

<http://eshop.prodance.cz/DetailPage.asp?DPG=83920>

Schéma výhybky:

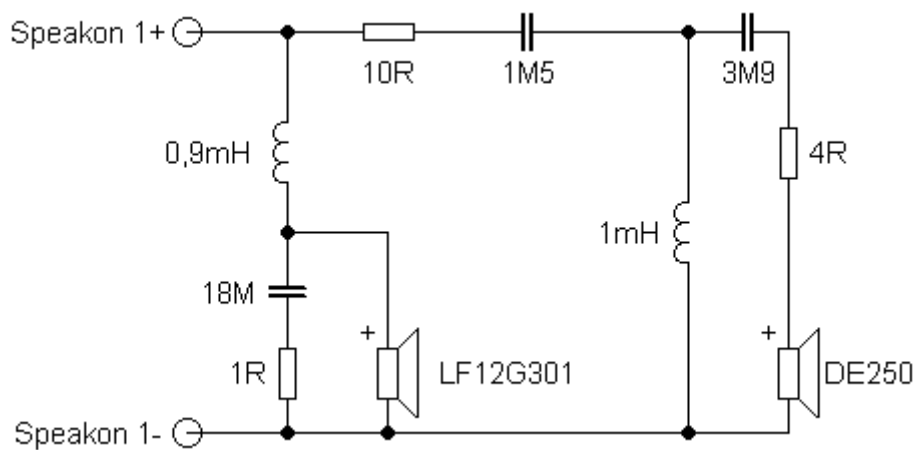

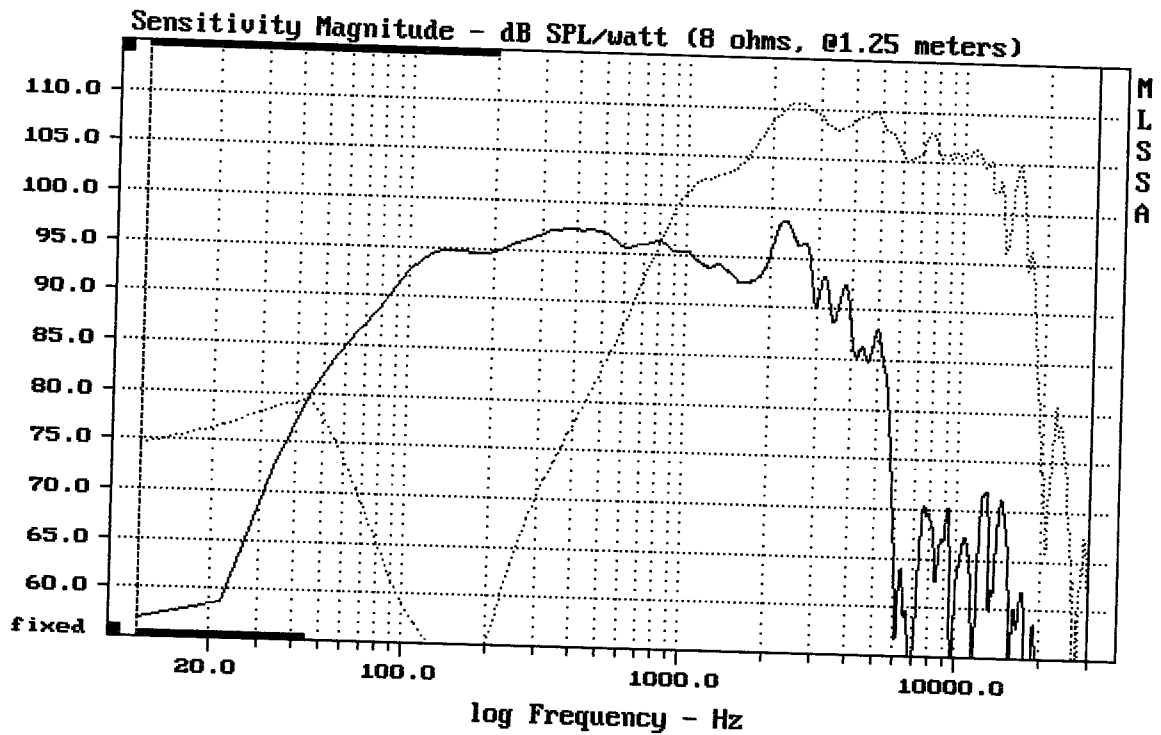

CURSOR: dy = 30.9395 x = 30007.1014 (2704)

LF12G301 + DE250 + A9090

MLSSA: Frequency Domain

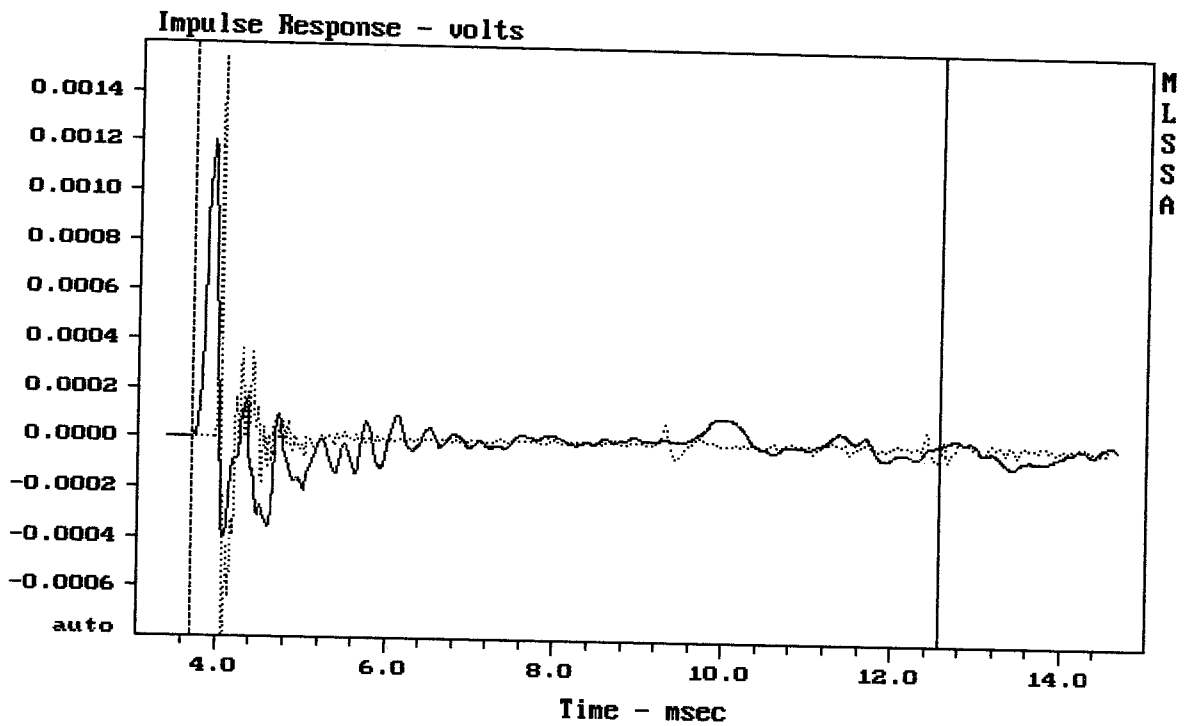

mean: -3.826e-007, rms: 0.0001263, std: 0.0001263, max: 0.001537, min: -0.0012

LF12G301 + DE250 + A9090

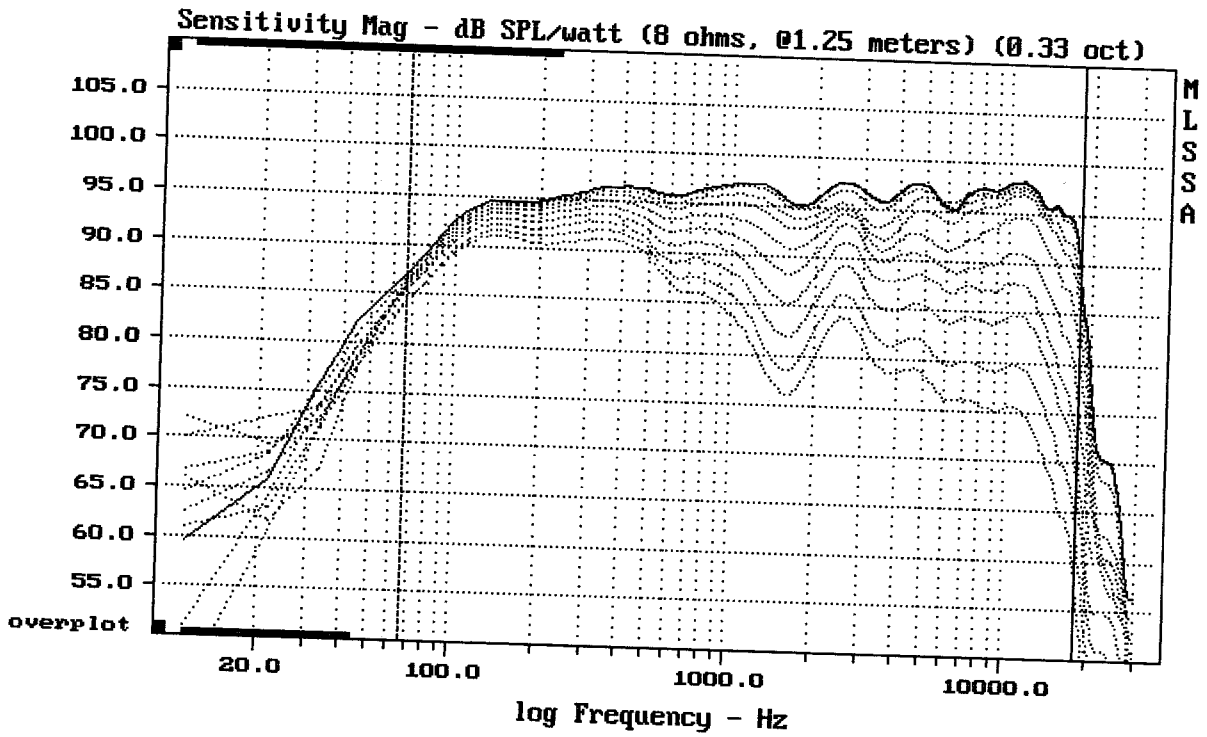

Overlay Compare: dev= +19/-9.4, std= 5.8, avg= -22

MLSSA: Frequency Domain

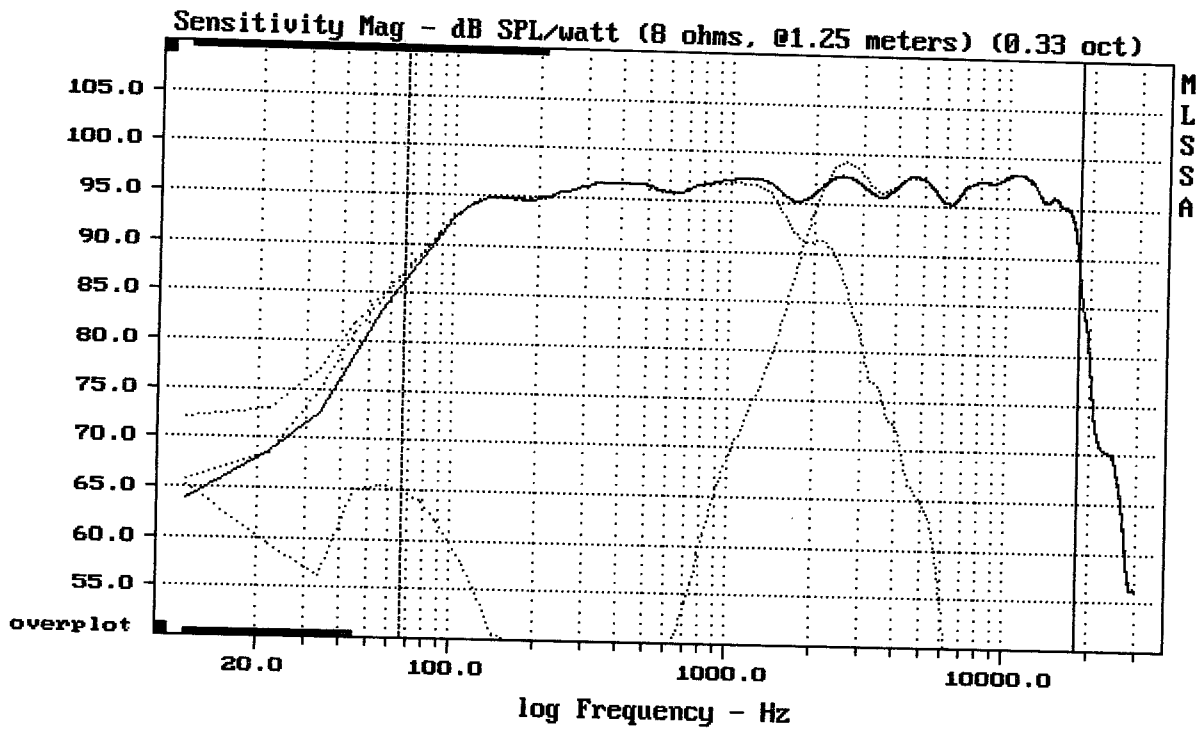

Level (67:18399 Hz) = 96.07 dB SPL/watt (8 ohms, 0.1.25 meters) (0.33 oct)

LF12G301 + DE250 + A9090

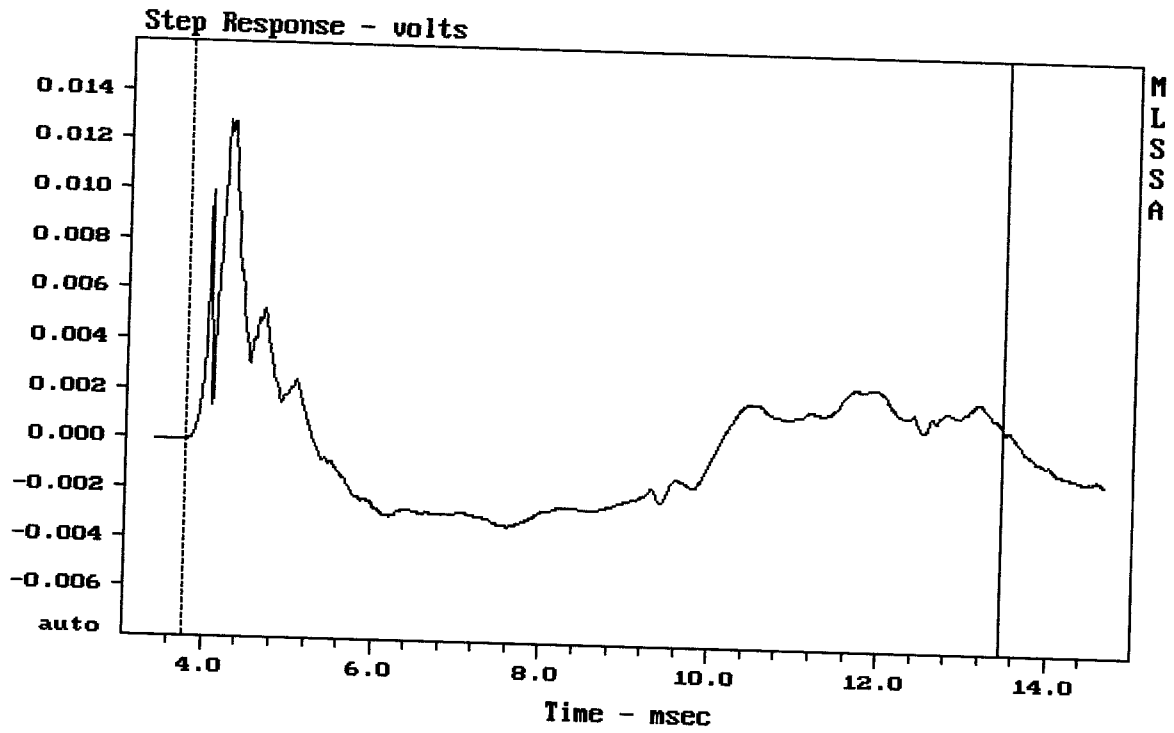

mean: 9.504e-005, rms: 0.002908, std: 0.002906, max: 0.01278, min: -0.003289

LF12G301 + DE250 + A9090

MLSSA: Time Domain

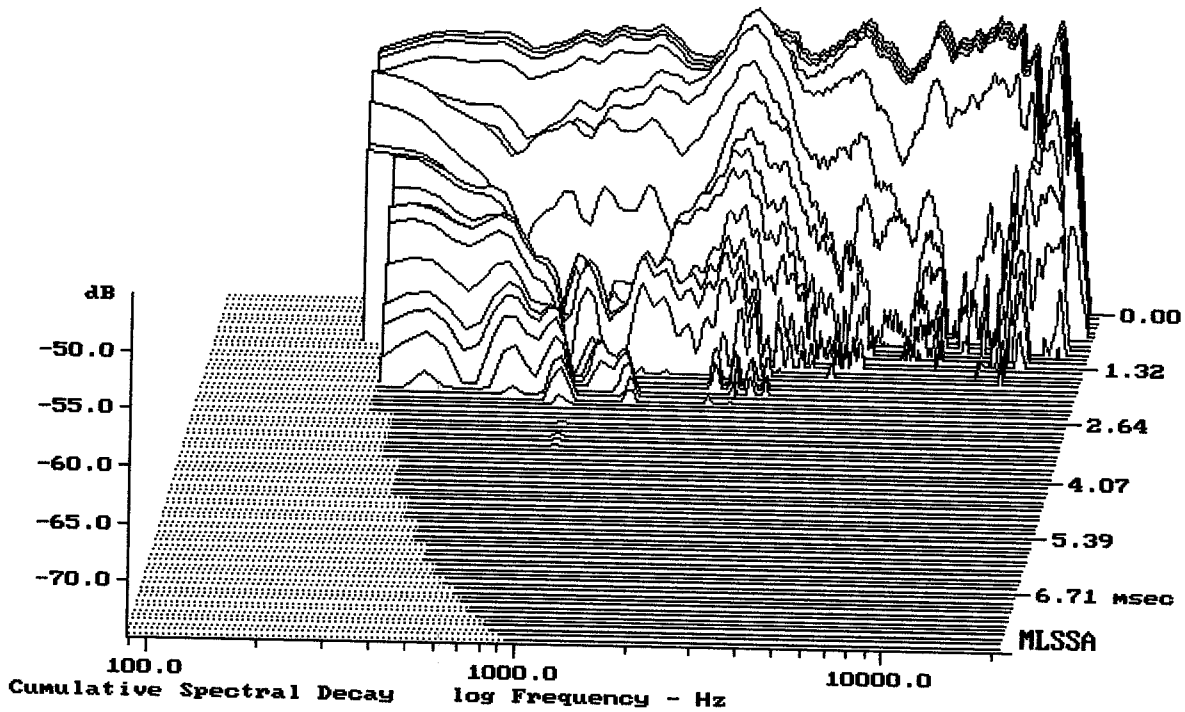

-74.05 dB, 2486 Hz (56), 2.090 msec (20)

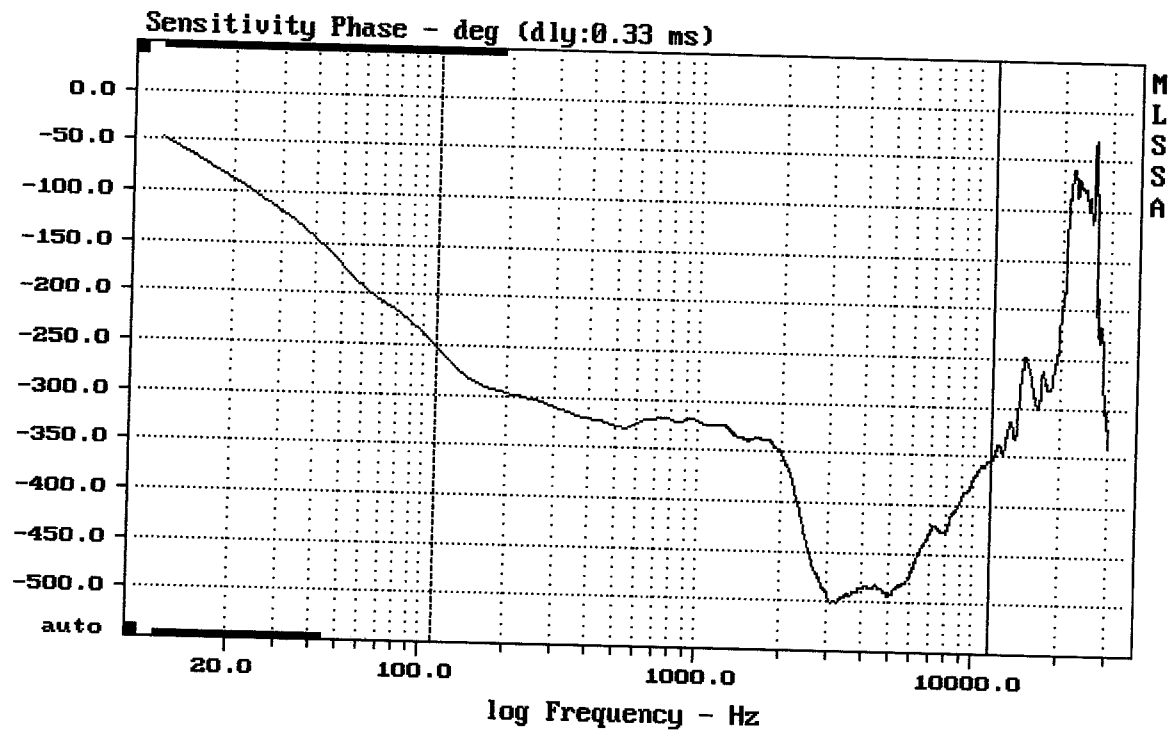

mean: -414, rms: 418.3, std: 59.85, max: -251.5, min: -500.8

LF12G301 + DE250 + A9090

MLSSA: Frequency Domain

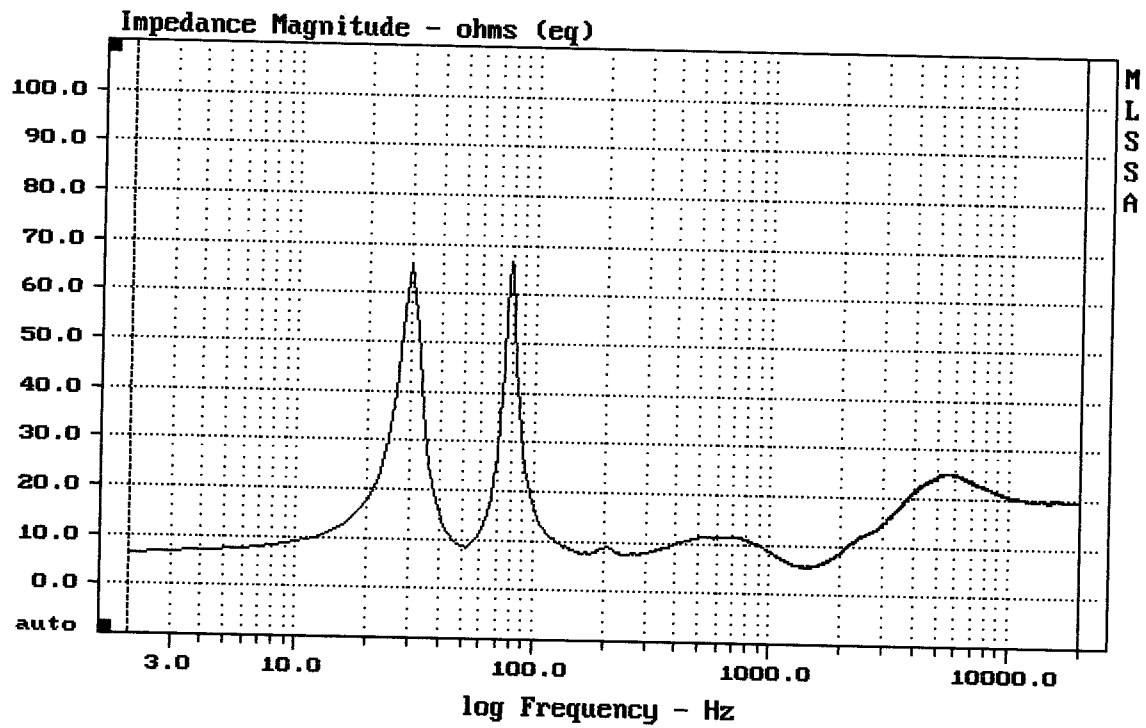

mean: 19.2, rms: 19.74, std: 4.605, max: 66.9, min: 5.677

LF12G301 + DE250 + A9090