

Sestava DAS 12P + B&C Speakers DE12 + Megaton A1040

Osazení:

- DAS 12P 8/Ohm

<http://eshop.prodance.cz/DetailPage.asp?DPG=82731>

- B&C Speakers DE12 8/Ohm

<http://eshop.prodance.cz/DetailPage.asp?DPG=82296>

- Megaton A1040

<http://eshop.prodance.cz/DetailPage.asp?DPG=83831>

Schéma výhybky:

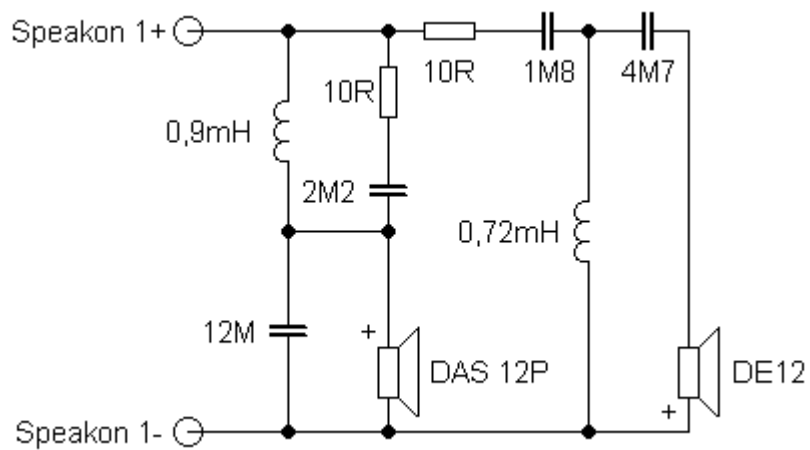

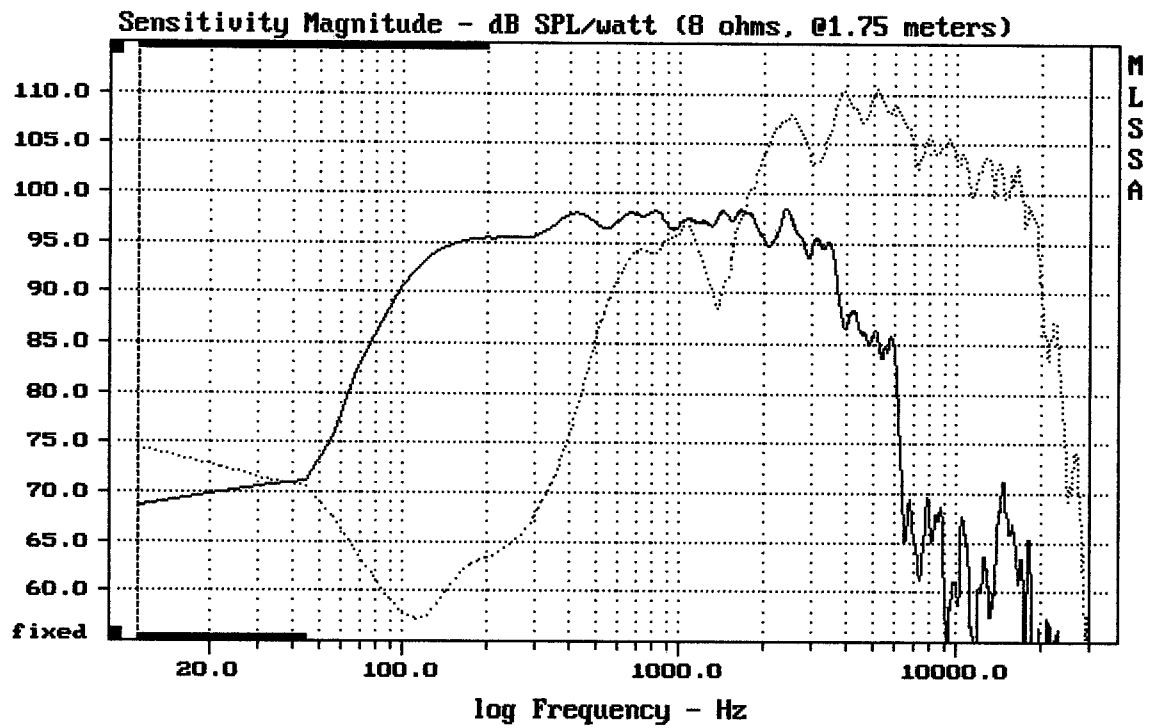

CURSOR: dy = 12.6341 x = 30007.1014 (2704)

DAS 12P + DE12 + A1040

MLSSA: Frequency Domain

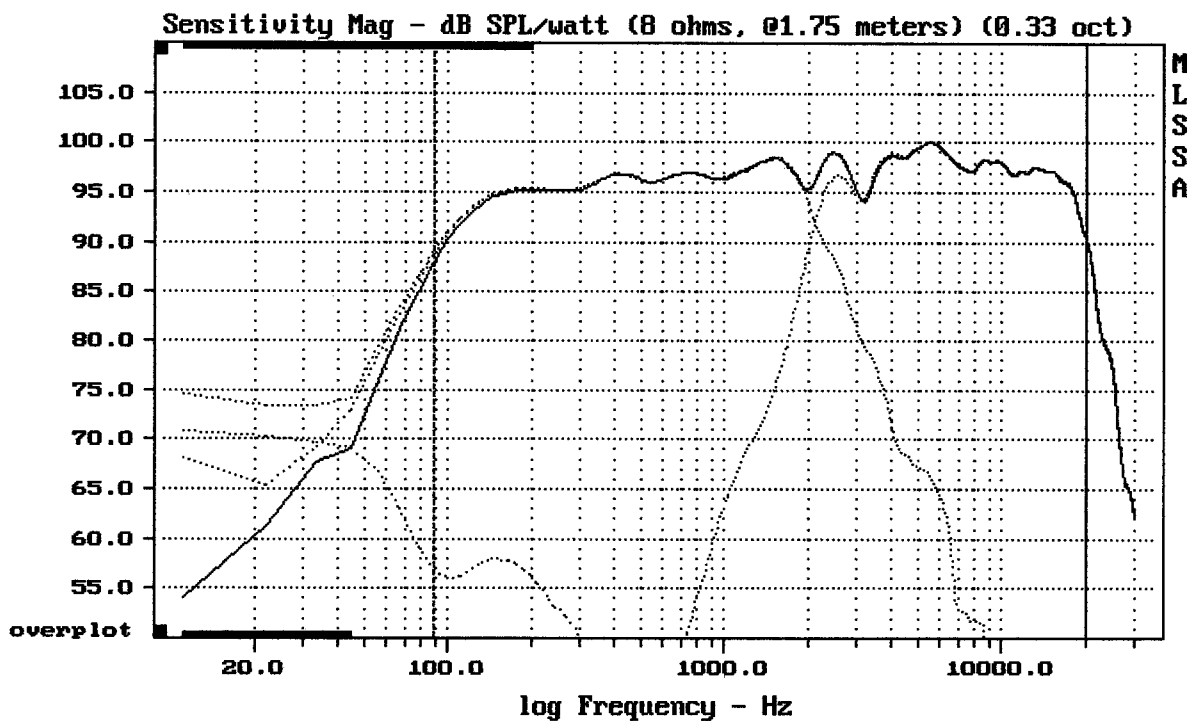

Level (89:19997 Hz) = 96.76 dB SPL/watt (8 ohms, @1.75 meters) (0.33 oct)

DAS 12P + DE12 + A1040

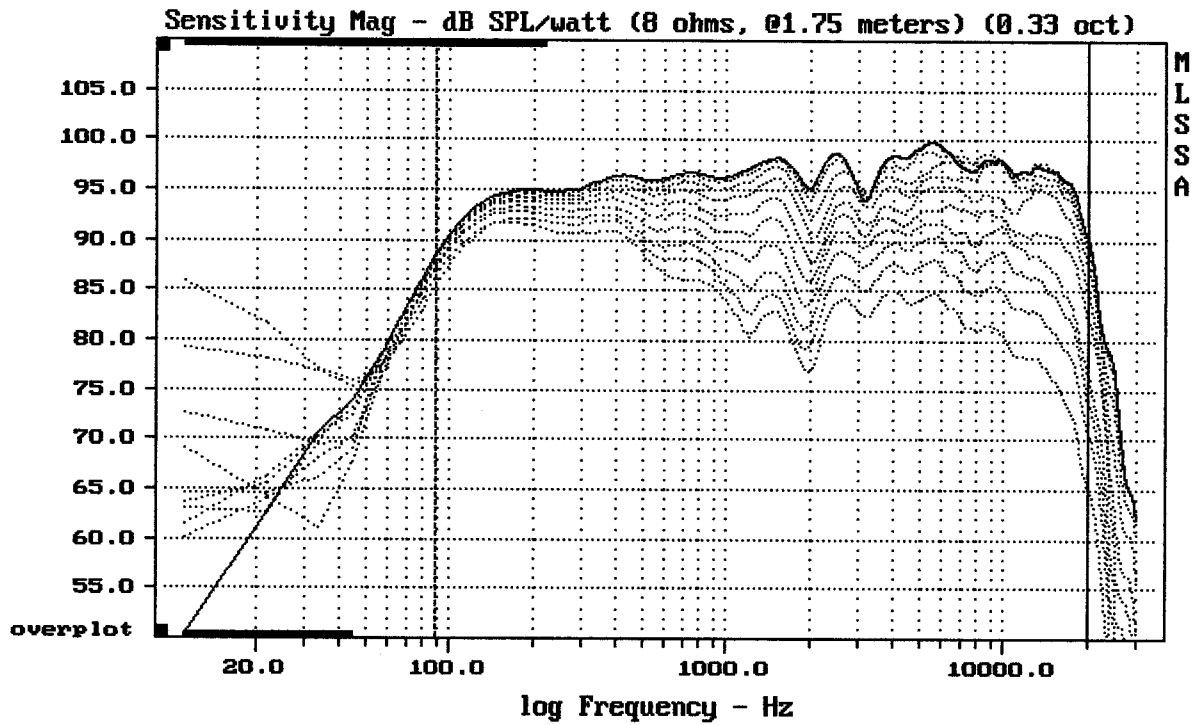

Overlay Compare: dev= +16/-7.6, std= 4.1, avg= -18

DAS 12P + DE12 + A1040

MLSSA: Frequency Domain

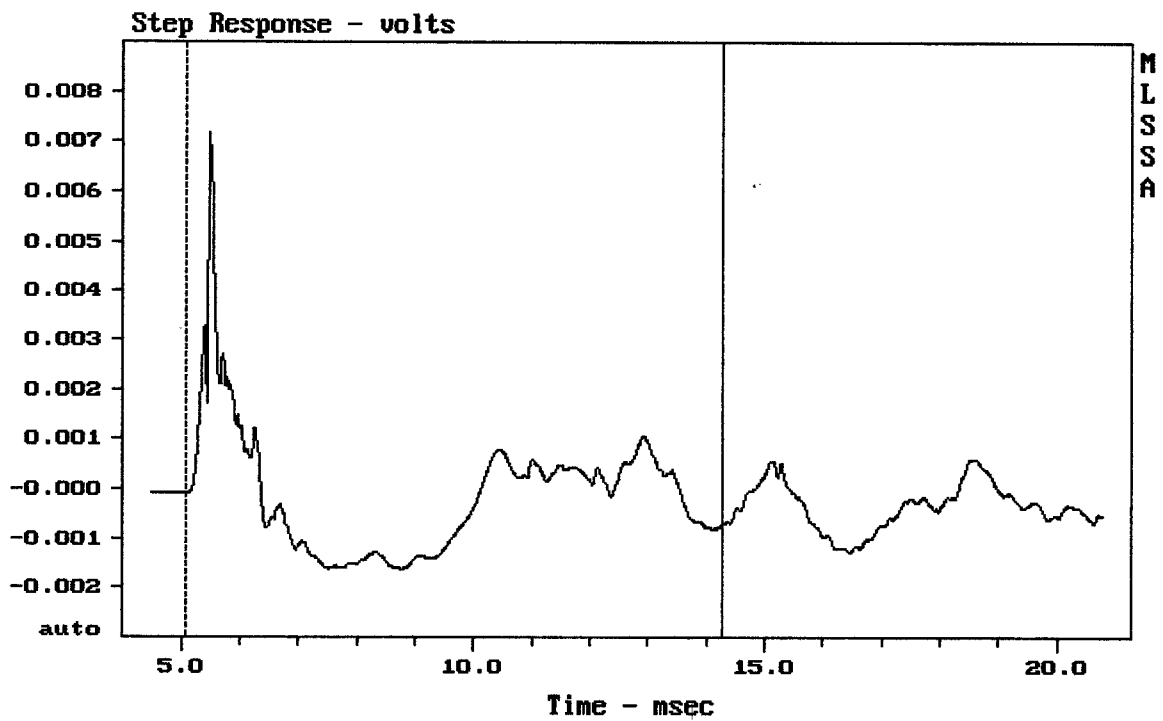

mean: -0.000137, rms: 0.001253, std: 0.001245, max: 0.007149, min: -0.001629

DAS 12P + DE12 + A1040

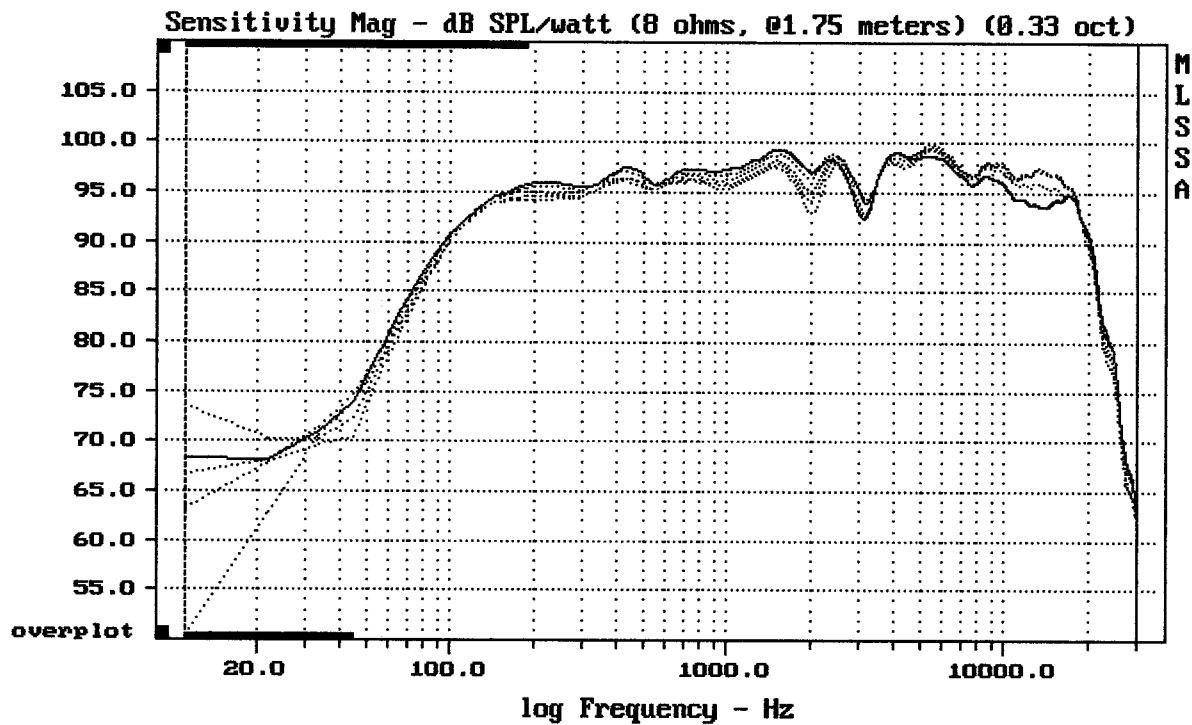

CURSOR: y = 62.0005 x = 30007.1014 (2704)

DAS 12P + DE12 + A1040

MLSSA: Frequency Domain

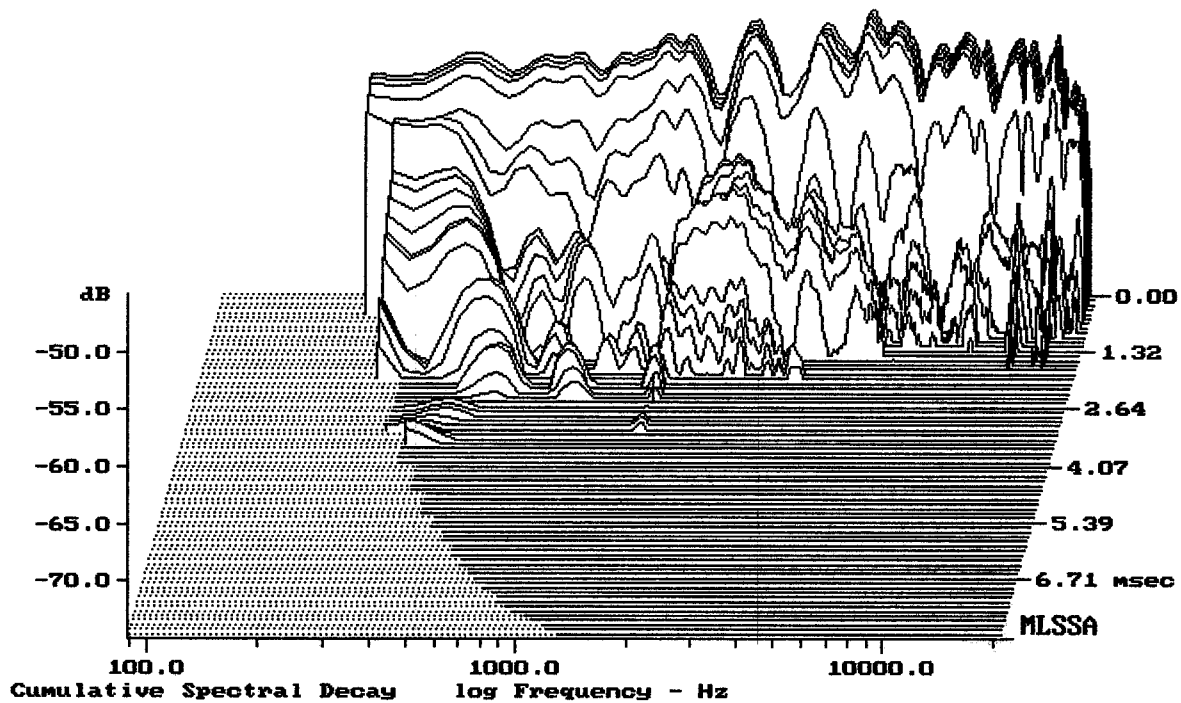

-74.23 dB, 1554 Hz (35), 2.420 msec (23)

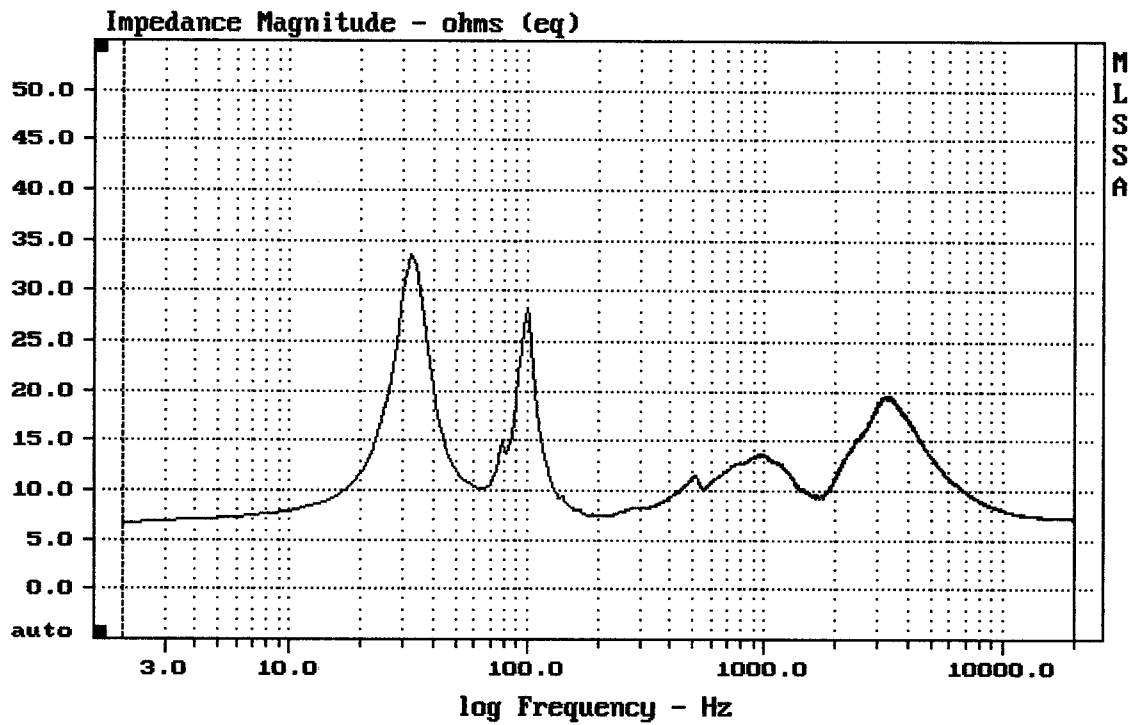

mean: 9.725, rms: 10.29, std: 3.373, max: 33.56, min: 6.778

DAS 12P + DE12 + A1040

MLSSA: Frequency Domain

