

## Sestava Eminence Delta-12 + B&C Speakers DE12 + Megaton A8080

### Osazení:

- Eminence Delta-12 8/Ohm

<http://eshop.prodance.cz/DetailPage.asp?DPG=82360>

- B&C Speakers DE12 8/Ohm

<http://eshop.prodance.cz/DetailPage.asp?DPG=82296>

- Megaton A8080

<http://eshop.prodance.cz/DetailPage.asp?DPG=83916>

### Schéma výhybky:

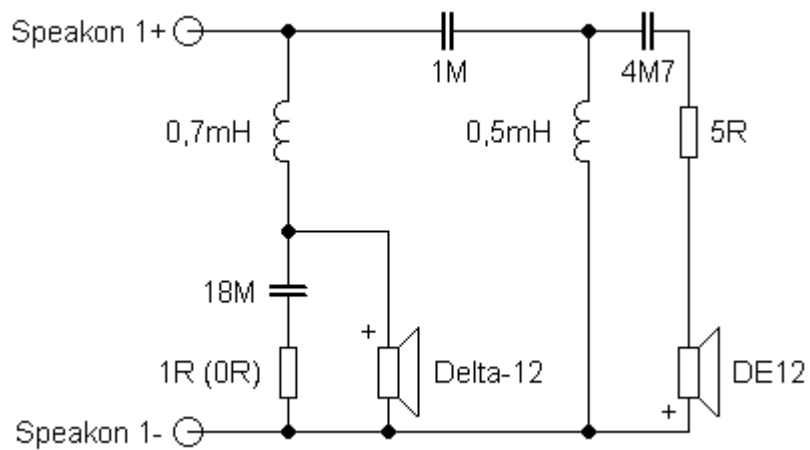

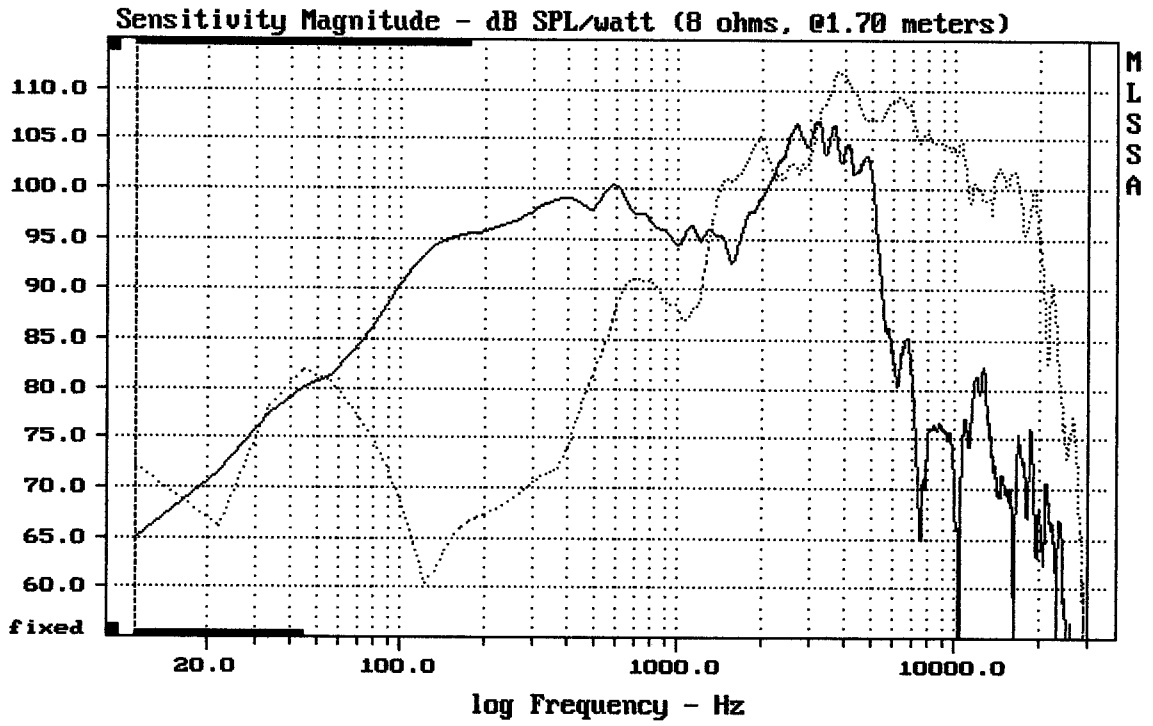

---

CURSOR: dy = 11.8302 x = 30007.1014 (2704)

---

DELTA12 + DE12 + A0080

MLSSA: Frequency Domain

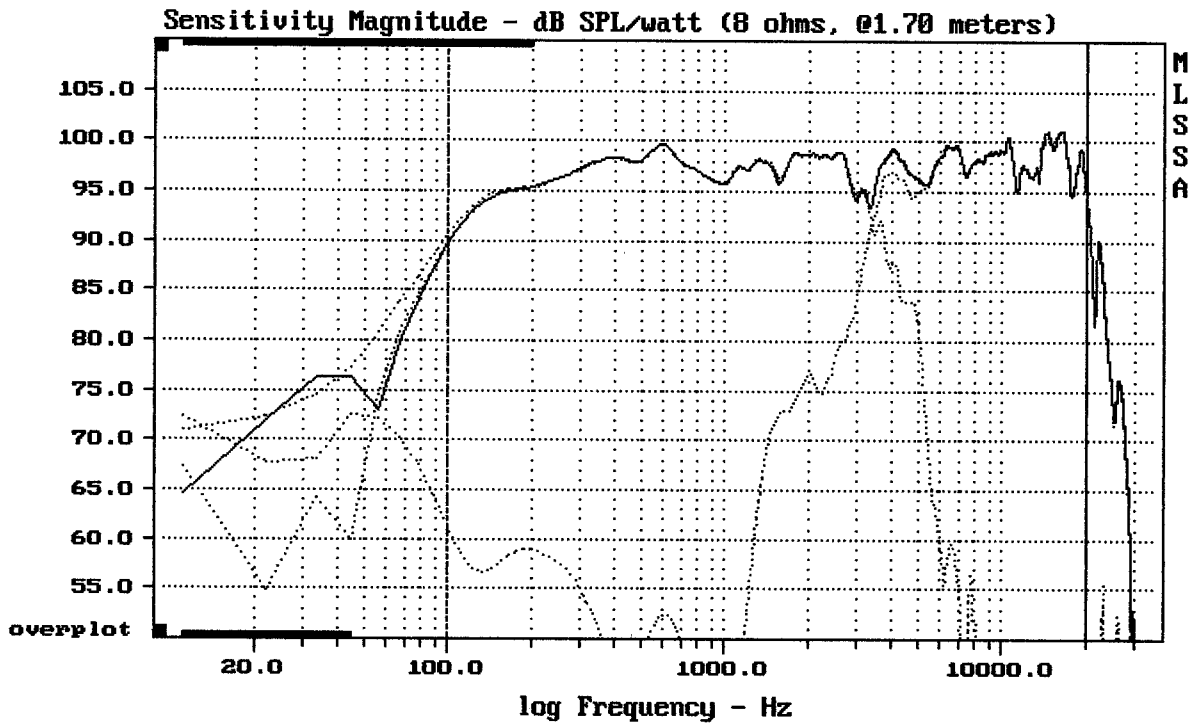



---

Level (100:20000 Hz) = 97.49 dB SPL/watt (8 ohms, @1.70 meters)

---

DELTA12 + DE12 + A8000

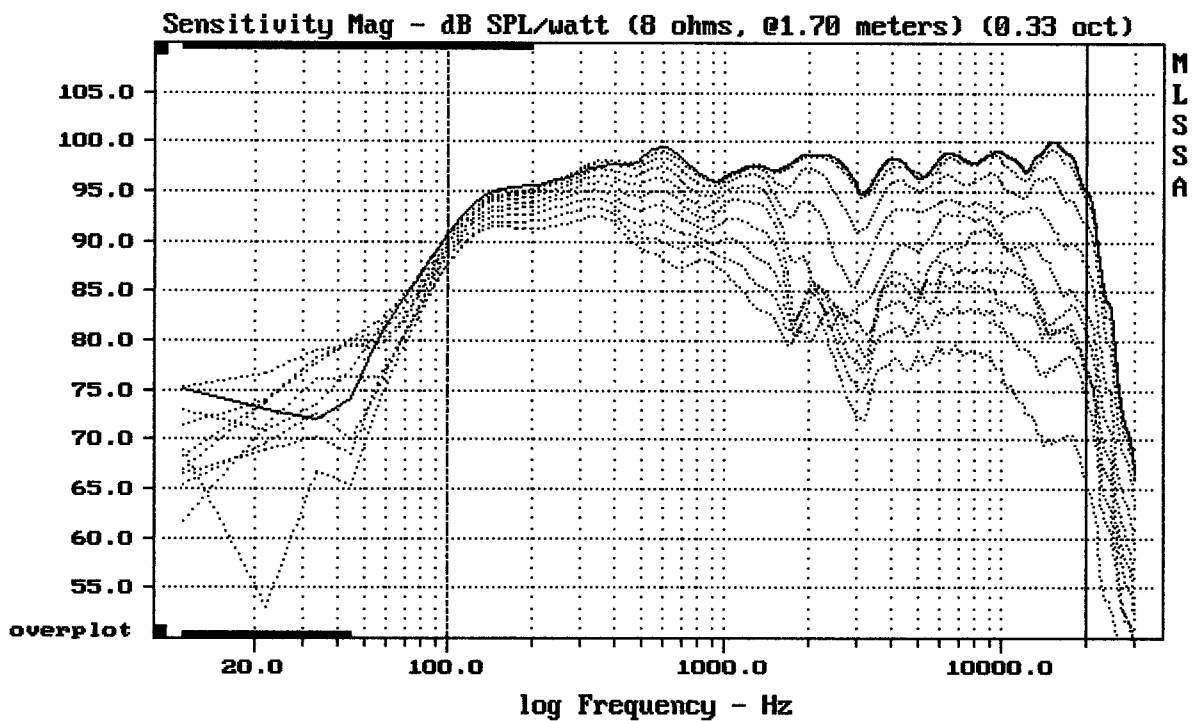
MLSSA: Frequency Domain





---

Overlay Compare: dev= +20/-7.7, std= 5.6, avg= -23

---

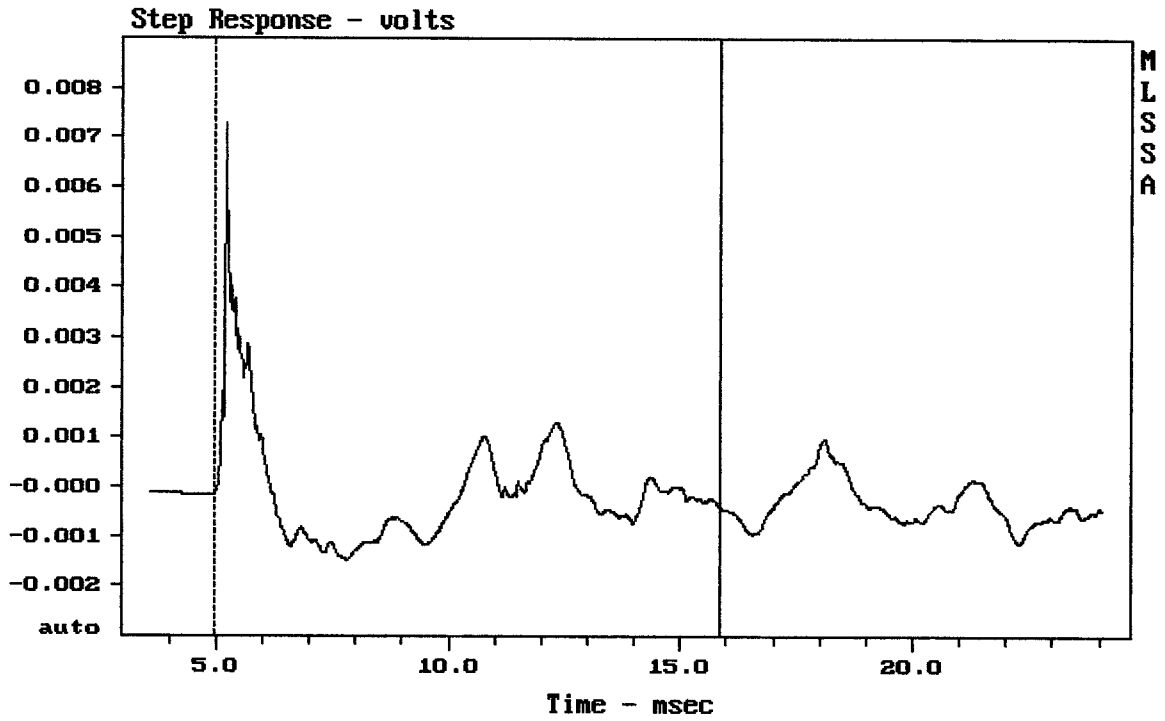
DELTA12 + DE12 + A8000



mean: -0.0001038, rms: 0.001128, std: 0.001123, max: 0.007281, min: -0.001477

DELTA12 + DE12 + A0080

MLSSA: Time Domain

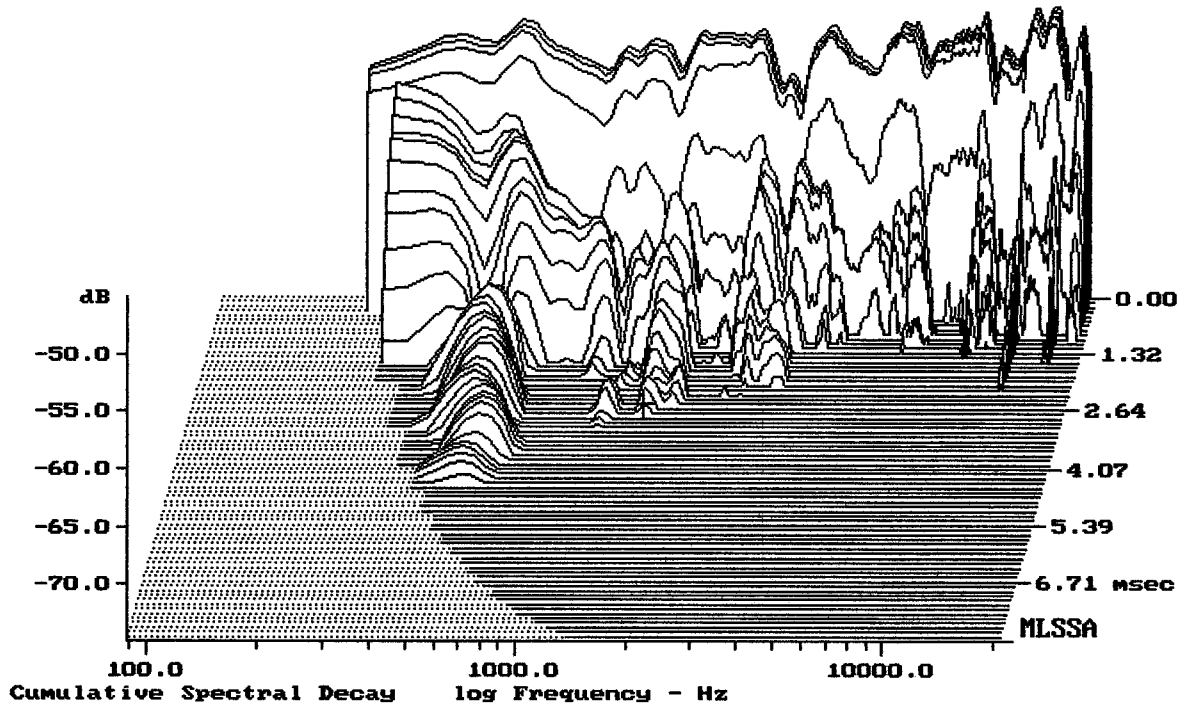

-74.13 dB, 1509 Hz (34), 2.750 msec (26)

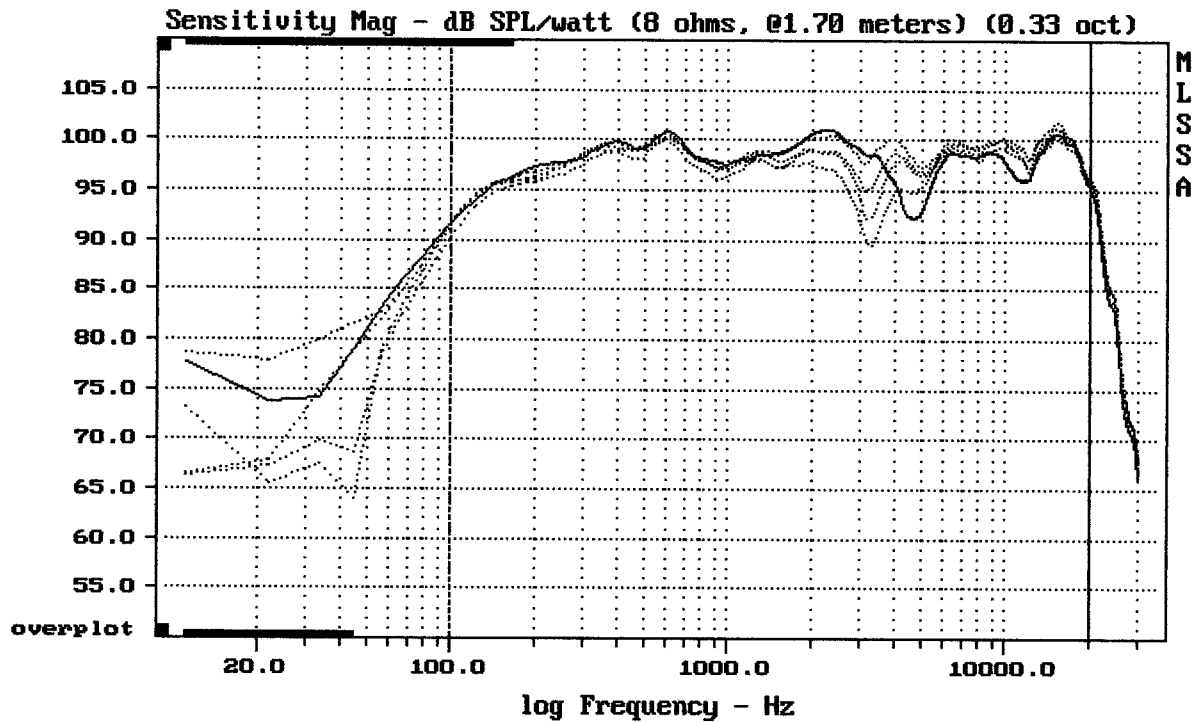

Overlay Compare: dev= +1.5/-6.3, std= 1.7, avg= 0.22

DELTA12 + DE12 + A8080

MLSSA: Frequency Domain

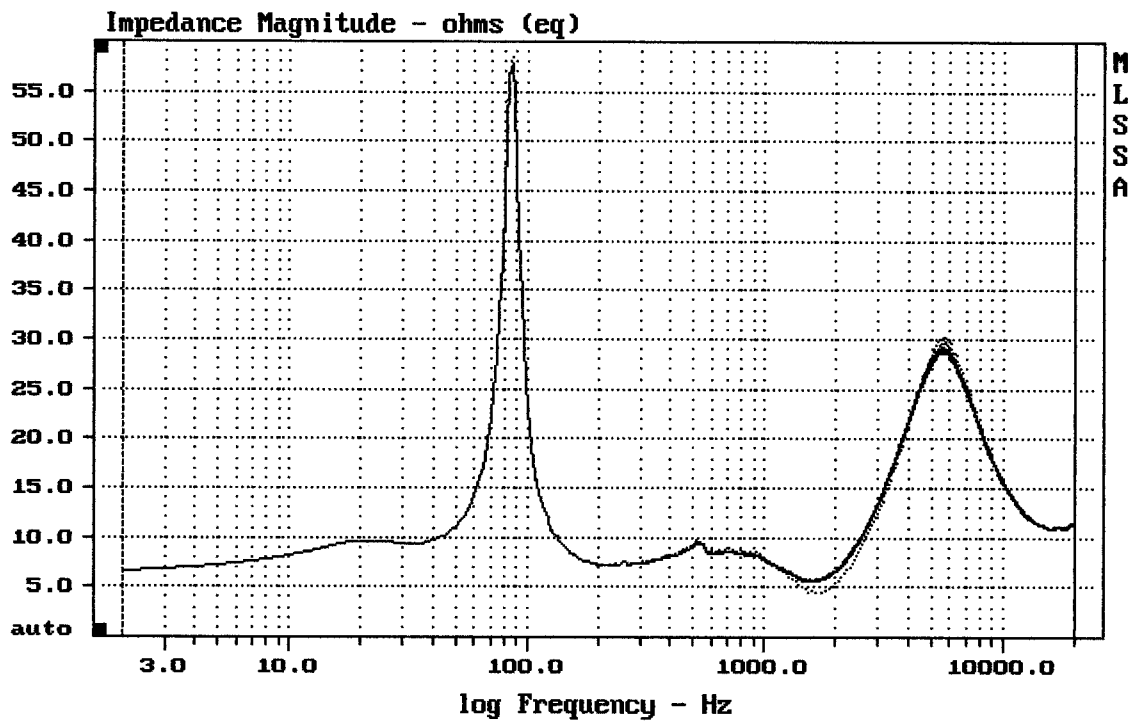

mean: 15.12, rms: 16.53, std: 6.695, max: 58.45, min: 4.387

DELTA12 + DE12 + A8080