

Sestava Eminence Delta 12LF + Selenium D220Ti + Selenium HM25-25

Osazení:

- Eminence Delta 12LF 8/Ohm

<http://eshop.prodance.cz/detailpage.asp?DPG=82361>

- Selenium D220Ti 8/Ohm

<http://eshop.prodance.cz/detailpage.asp?DPG=90316>

- Selenium HM25-25

<http://eshop.prodance.cz/detailpage.asp?DPG=81673>

Schéma výhybky:

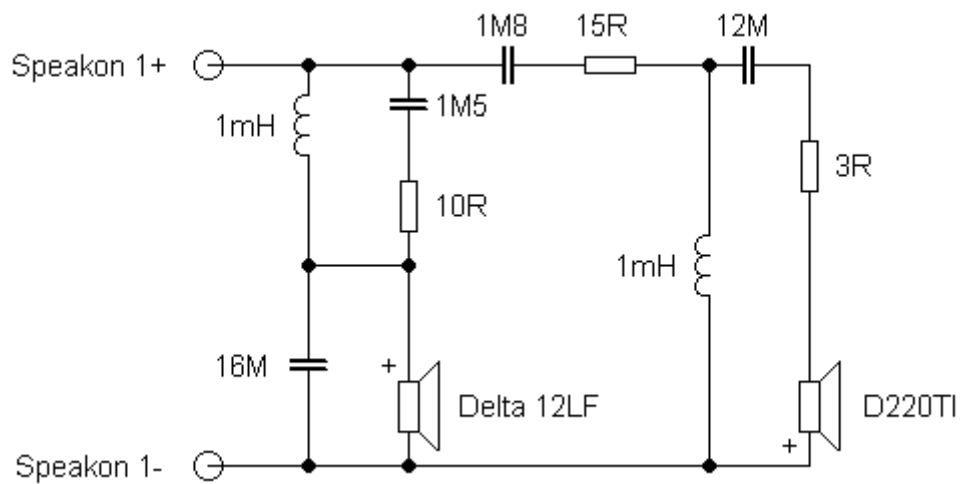

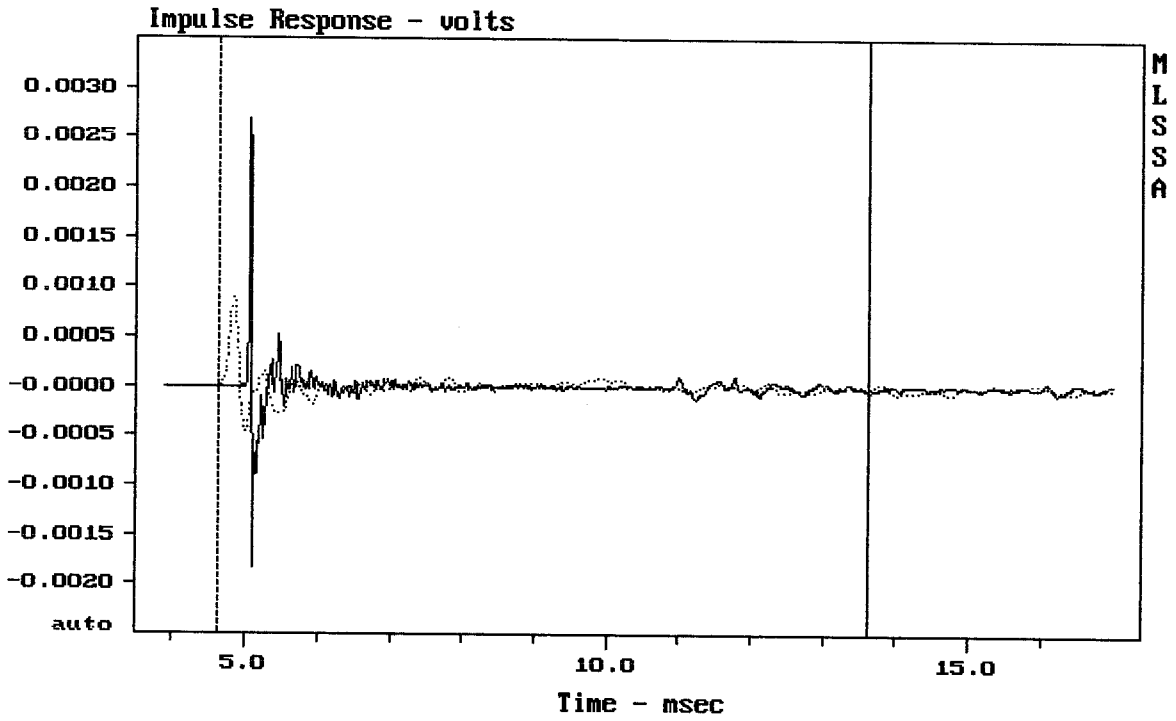

CURSOR: $dy = 2.07949e-005$ $x = 13.6070$ (1237)

DELTA12LF + D220TI + HM25-25

MLSSA: Time Domain

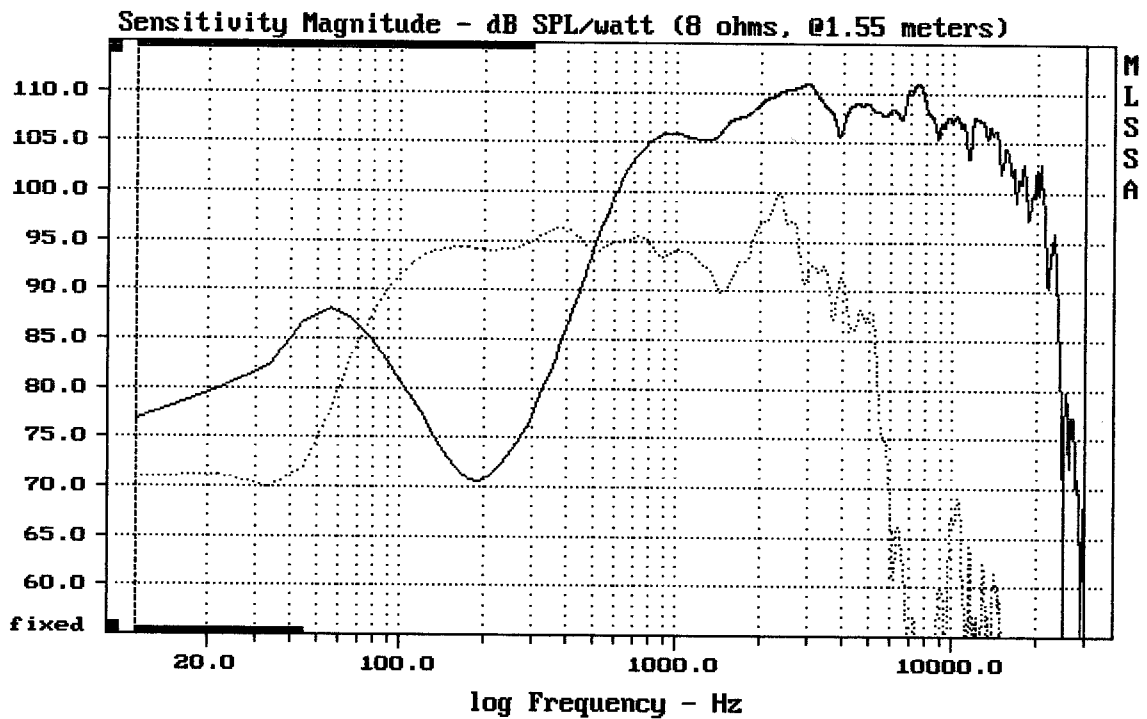

CURSOR: $dy = -39.5765$ $x = 30007.1014$ (2704)

DELTA12LF + D220TI + HM25-25

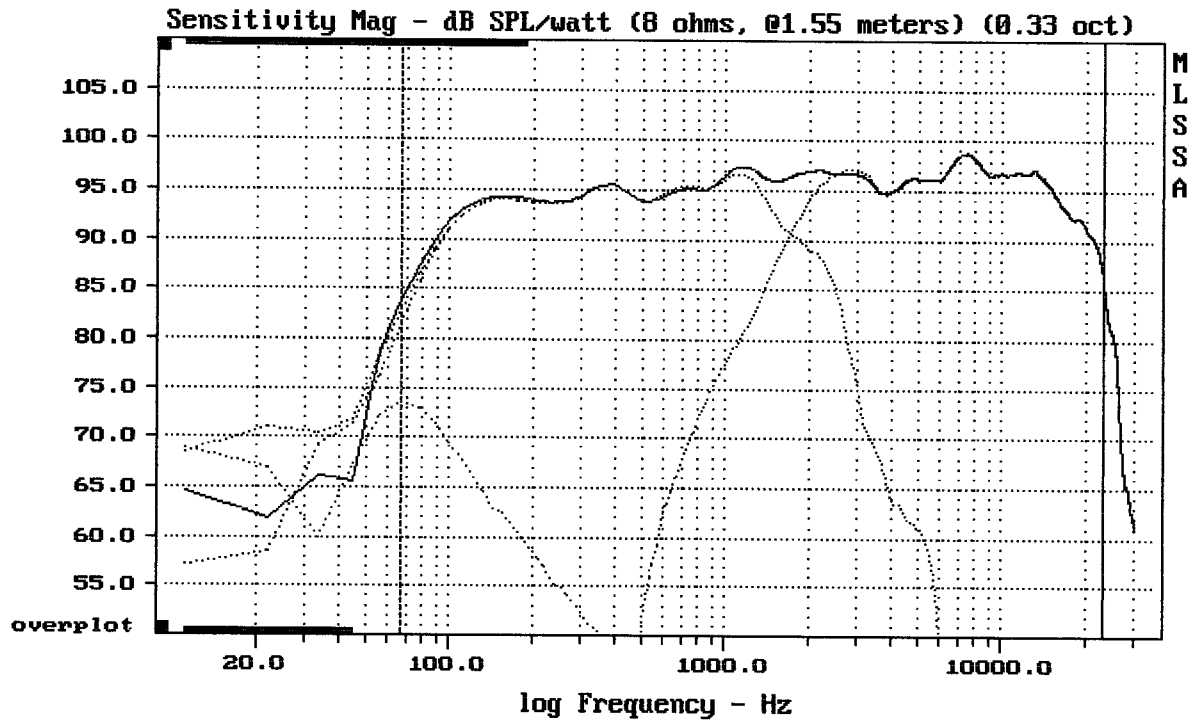

Level (67:23304 Hz) = 95.27 dB SPL/watt (8 ohms, @1.55 meters) (0.33 oct)

DELTA12LF + D220TI + HM25-25

MLSSA: Frequency Domain

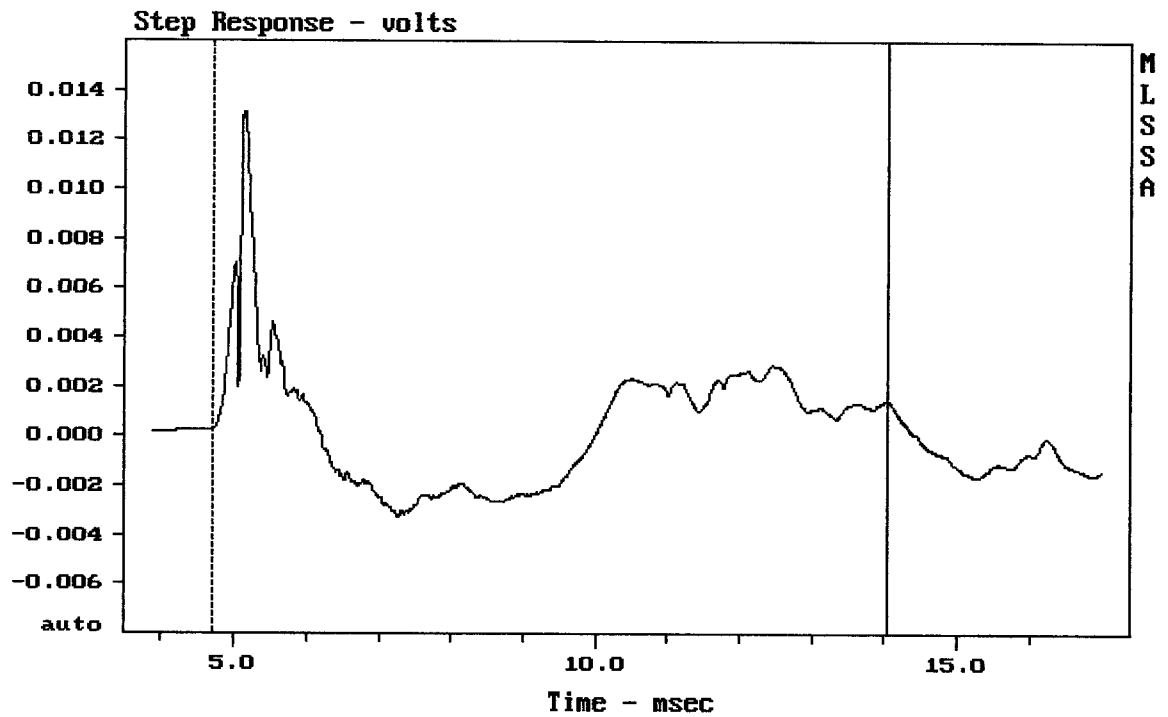

mean: 0.0004897, rms: 0.002671, std: 0.002625, max: 0.01314, min: -0.003244

DELTA12LF + D220TI + HM25-25

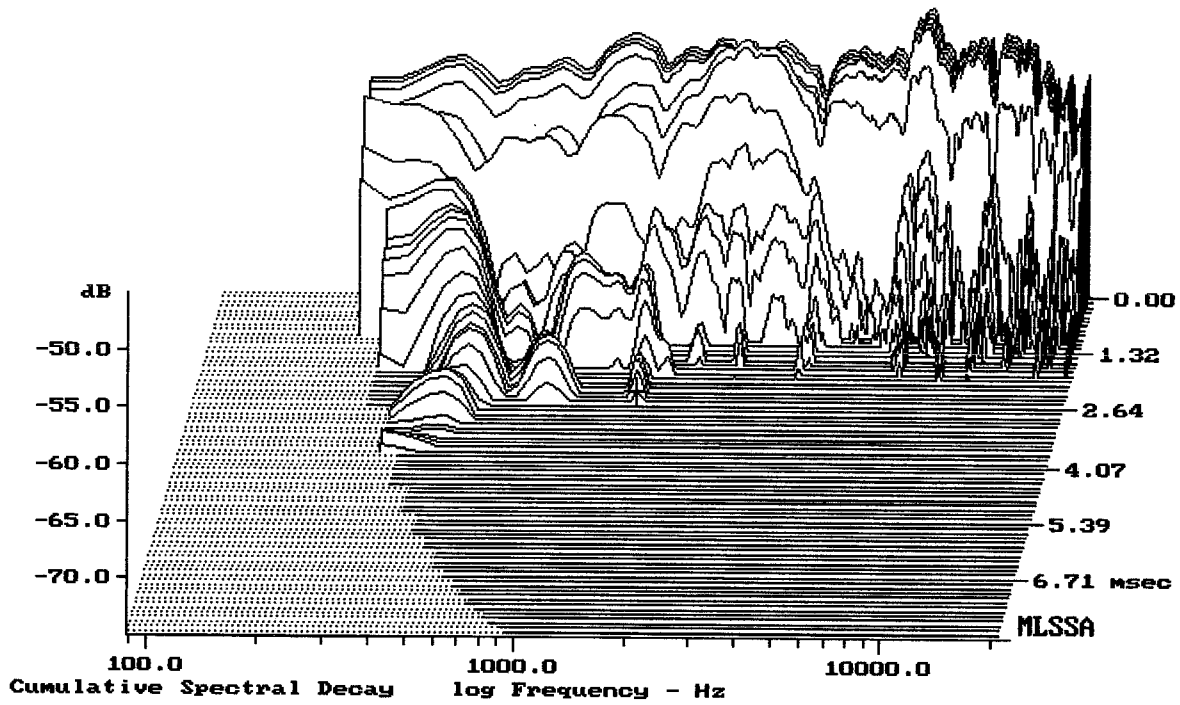

-74.13 dB, 1420 Hz (32), 2.530 msec (24)

DTTO

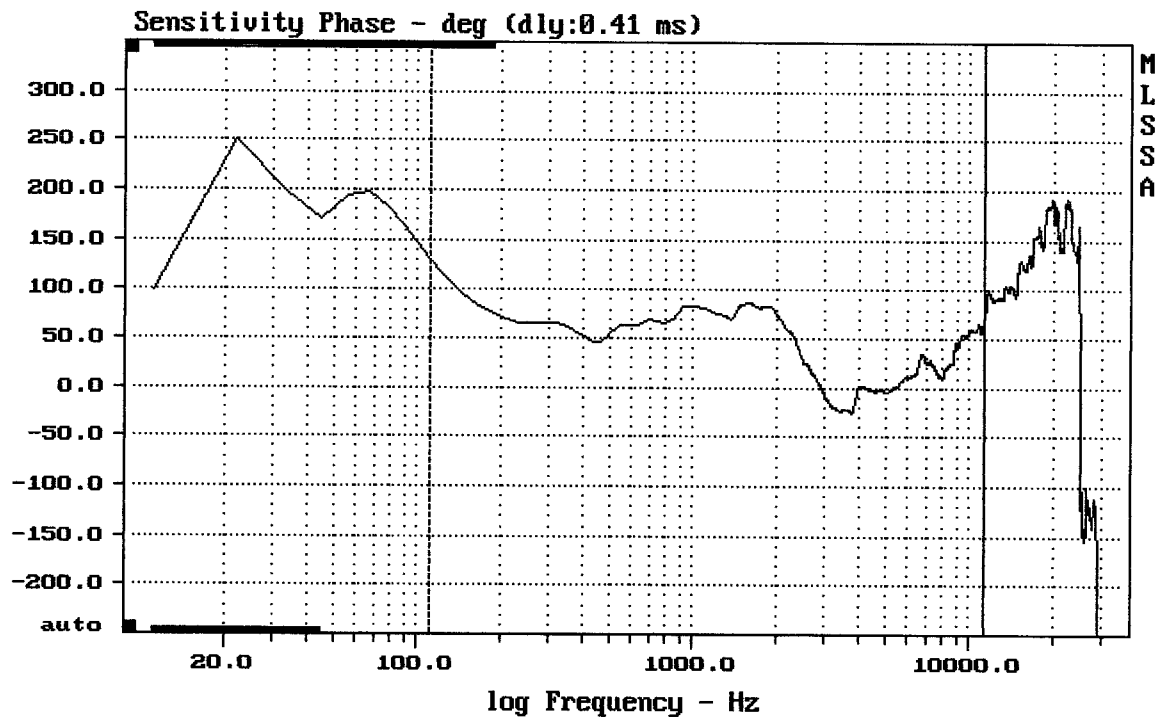

mean: 31.91, rms: 44.6, std: 31.16, max: 130.8, min: -25.02

DELTA12LF + D220TI + HM25-25

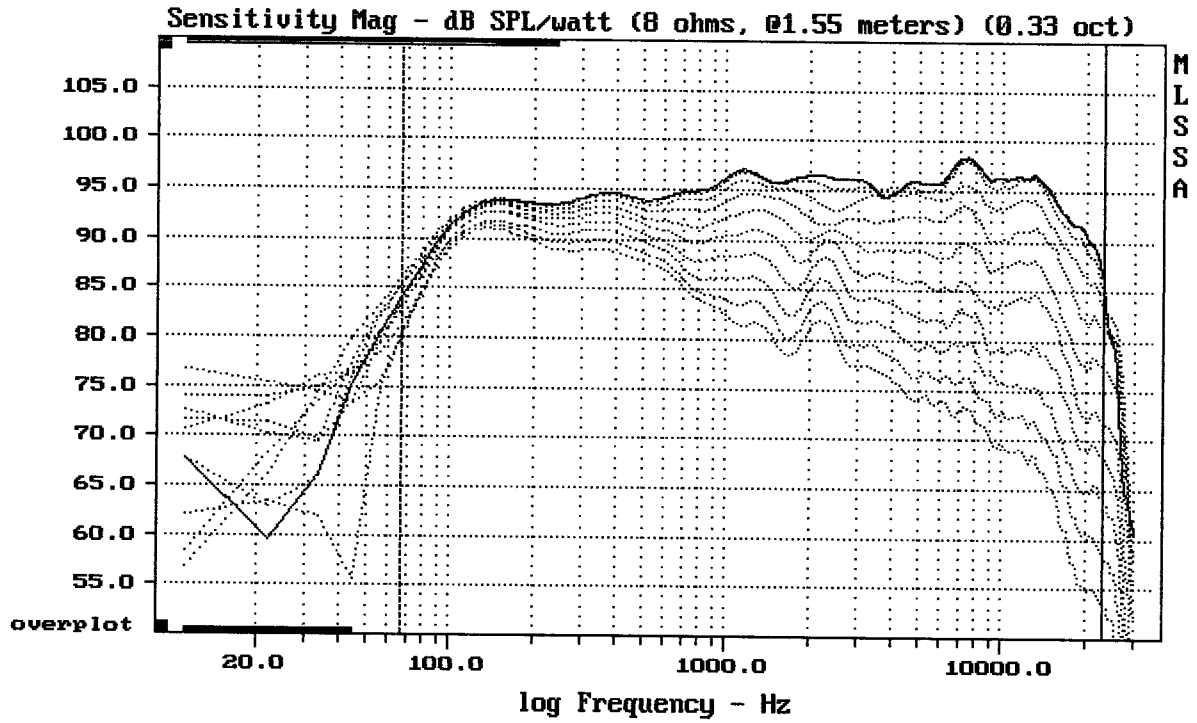

Overlay Compare: dev= +25/-9.5, std= 7.1, avg= -27

DELTA12LF + D220TI + HM25-25

MLSSA: Frequency Domain

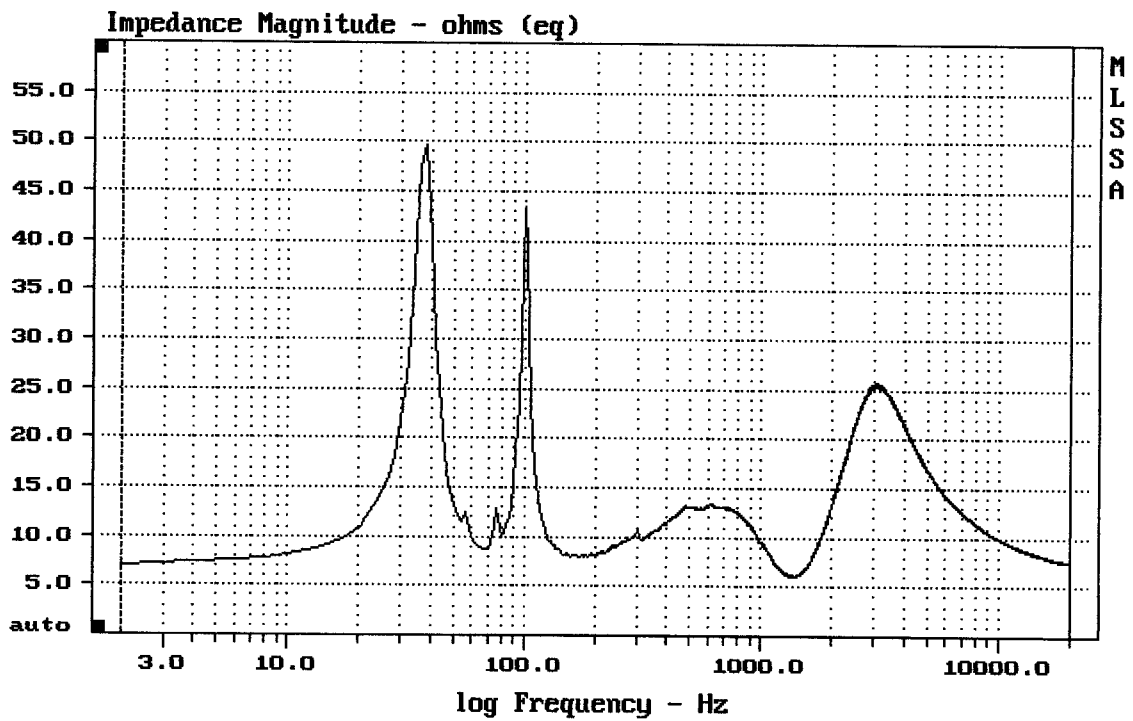

mean: 11.51, rms: 12.5, std: 4.879, max: 49.74, min: 5.999

DELTA12LF + D220TI + HM25-25