

## Sestava Eminence Kappa-15LF + B&C Speakers DE75PTN + Megaton C7560

### Osazení:

- Eminence Kappa-15LF 8/Ohm  
<http://eshop.prodance.cz/DetailPage.asp?DPG=81081>
- B&C Speakers DE75PTN 8/Ohm  
<http://eshop.prodance.cz/DetailPage.asp?DPG=82330>
- Megaton C7560  
<http://eshop.prodance.cz/DetailPage.asp?DPG=84634>

### Schéma výhybky:

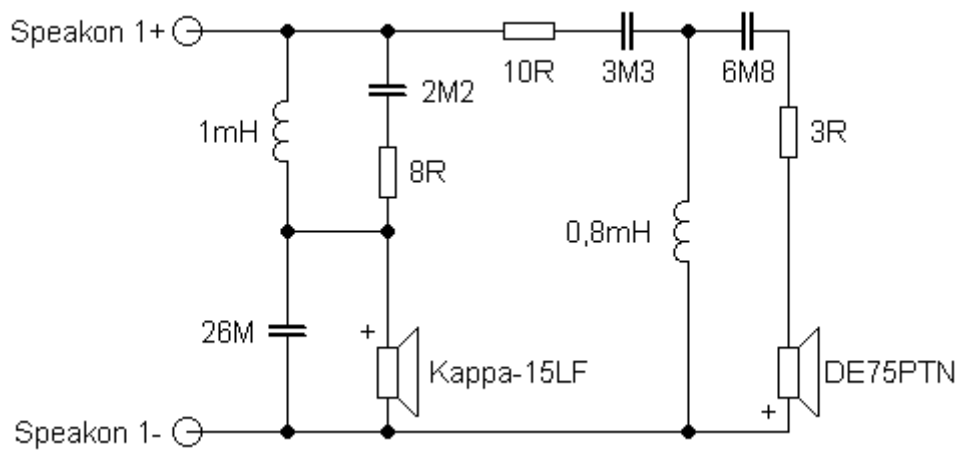

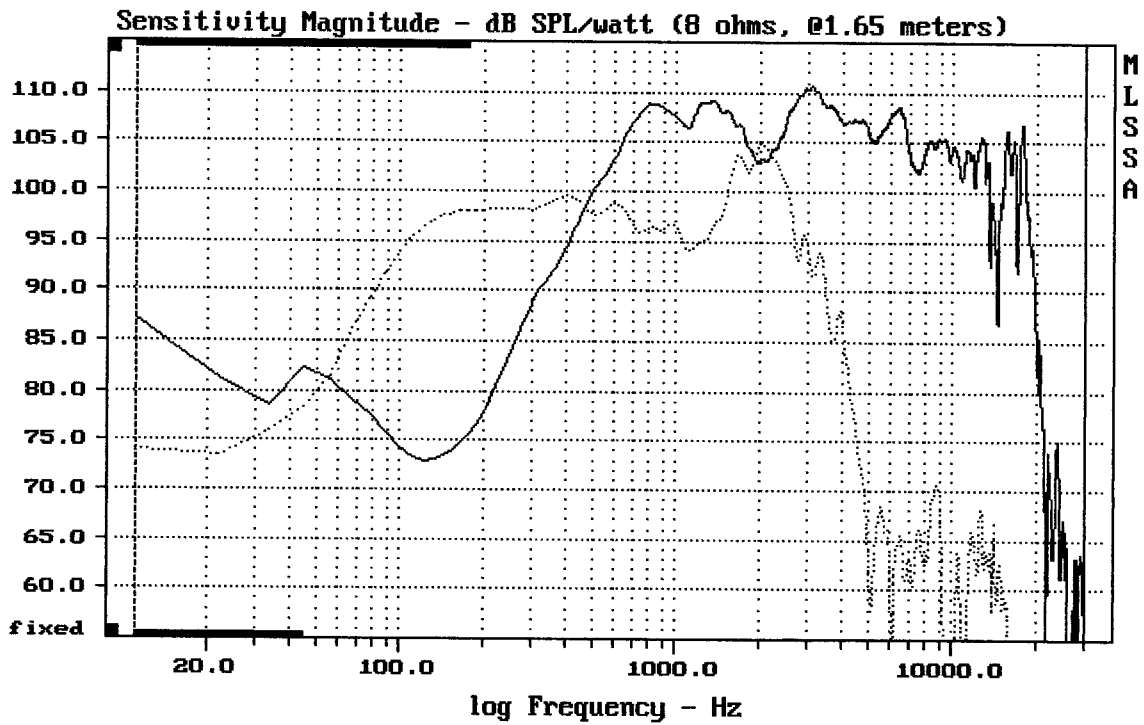

CURSOR: dy = -25.9131 x = 30007.1014 (2704)

EMINENCE KAPPA 15LF + DE75 + C7560

MLSSA: Frequency Domain

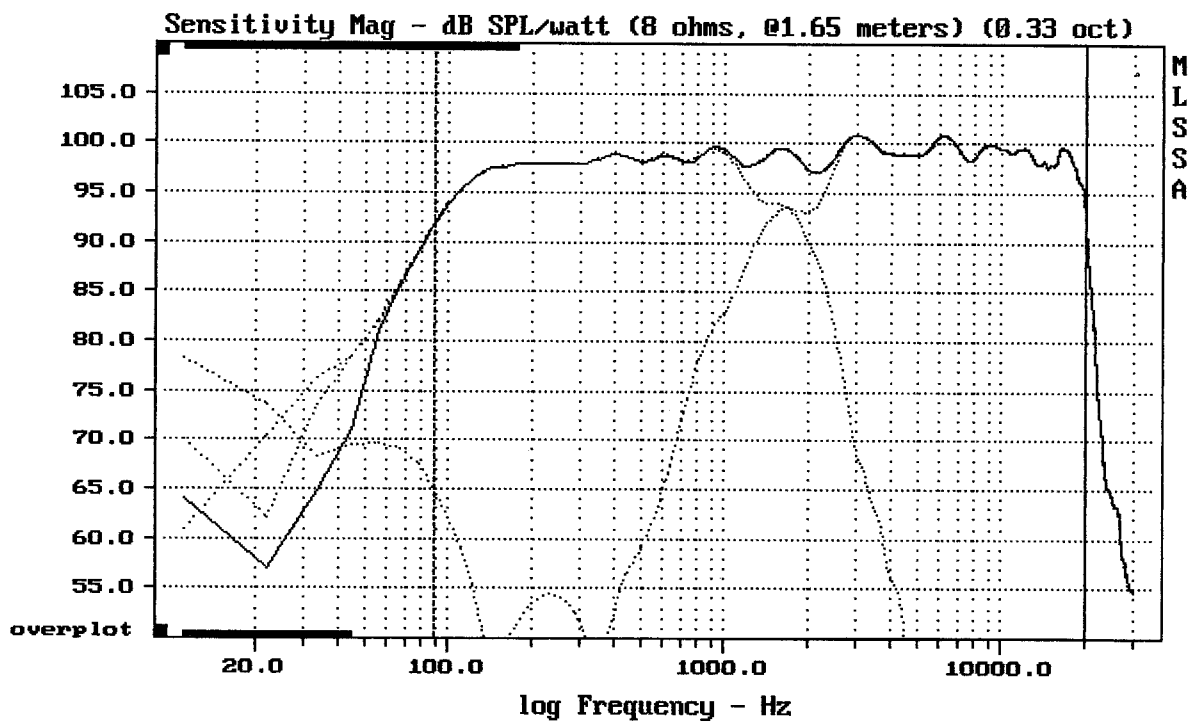

Level (89:1997 Hz) = 98.56 dB SPL/watt (8 ohms, @1.65 meters) (0.33 oct)

EMINENCE KAPPA 15LF + DE75 + C7560

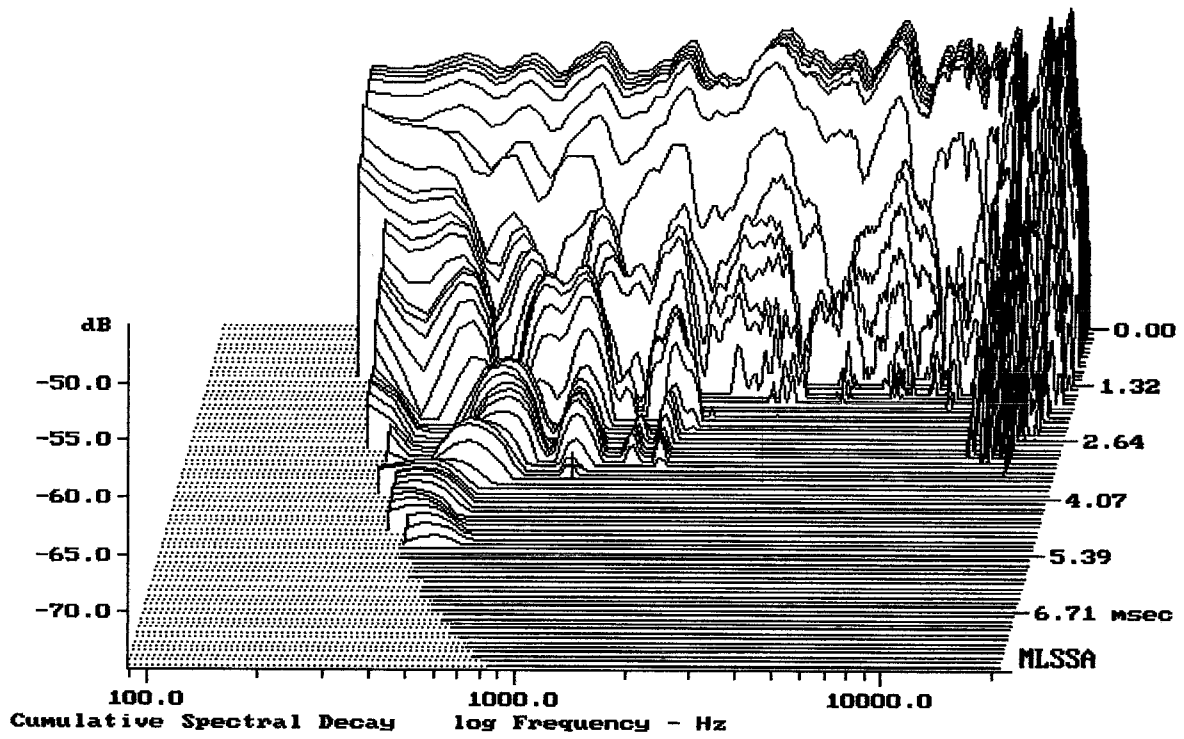

-74.25 dB, 1021 Hz (23), 3.520 msec (33)

DTTO

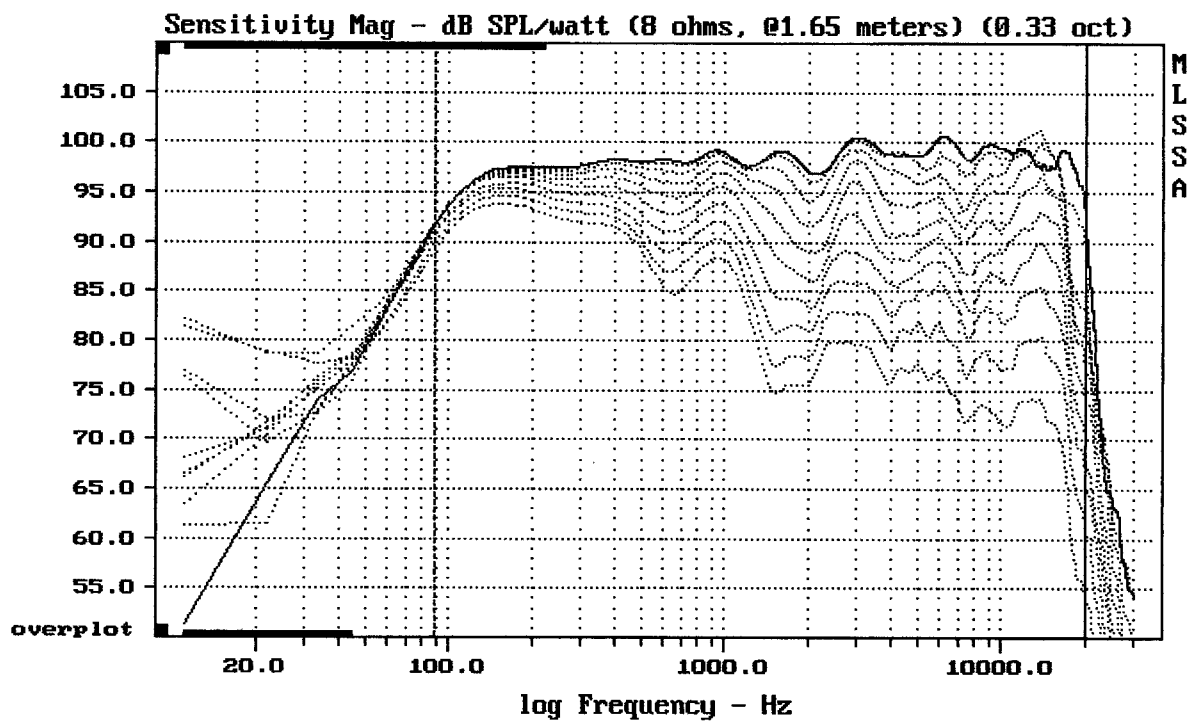

Overlay Compare: dev= +23/-14, std= 6.8, avg= -26

EMINENCE KAPPA 15LF + DE75 + C7560

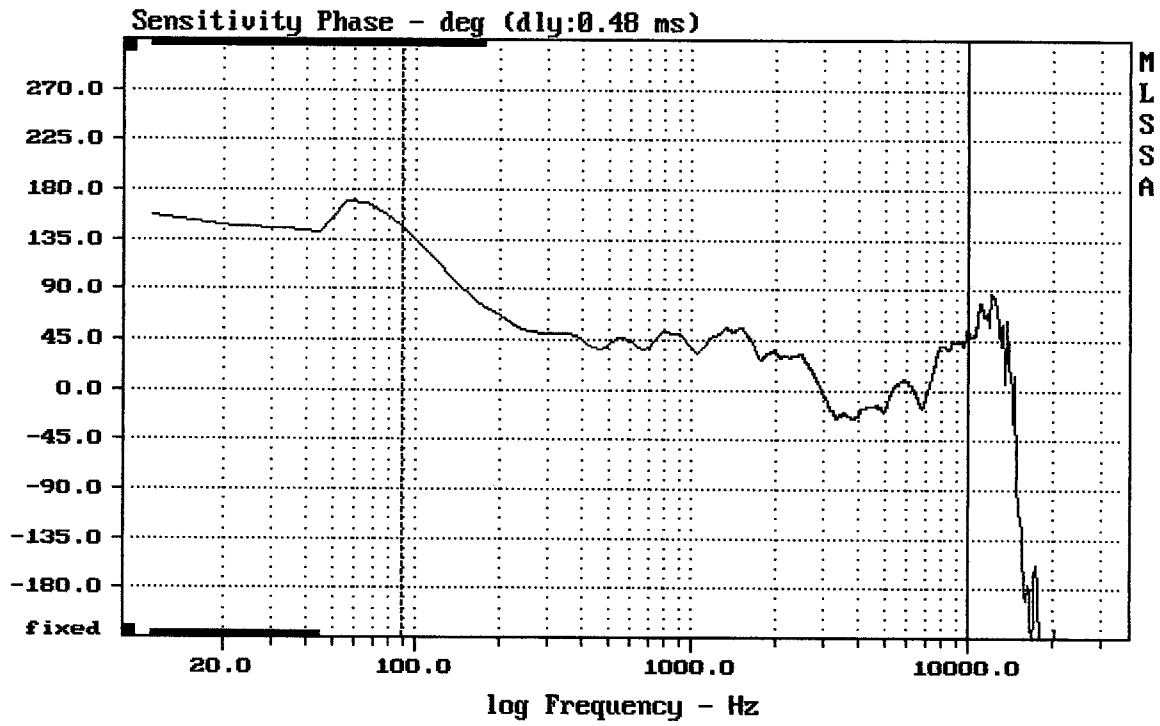

mean: 18.4, rms: 32.98, std: 27.38, max: 147, min: -25.93

EMINENCE KAPPA 15LF + DE75 + C7560

MLSSA: Frequency Domain

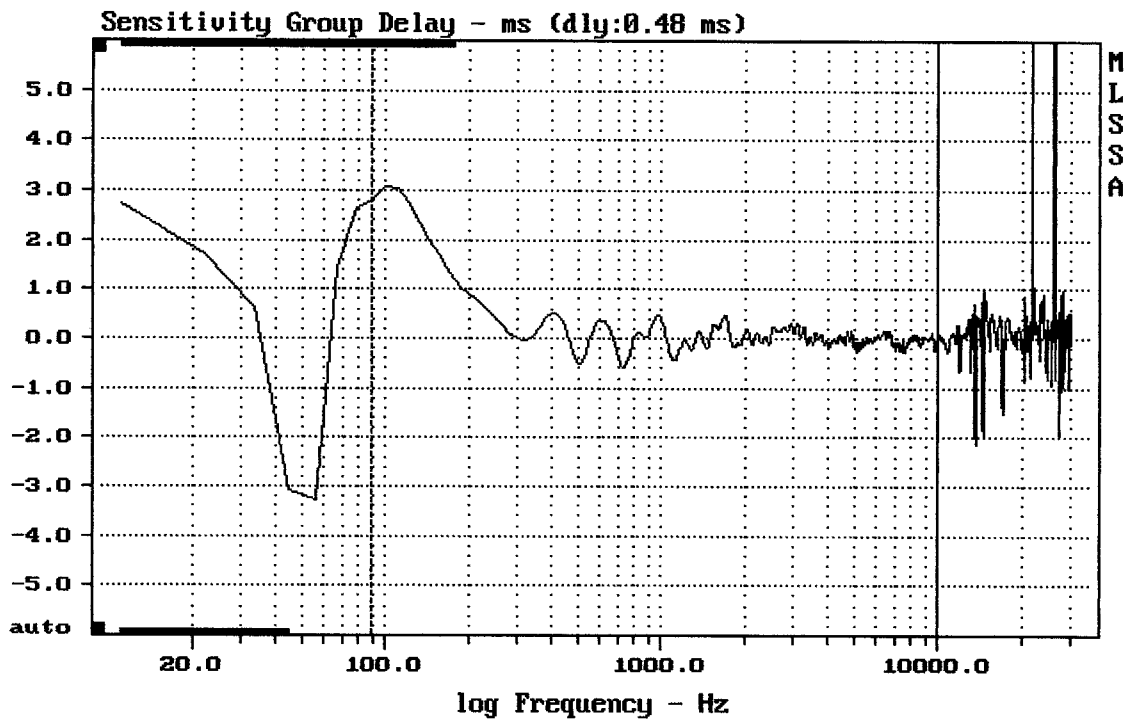

mean: 0.02785, rms: 0.2862, std: 0.2849, max: 3.065, min: -0.576

EMINENCE KAPPA 15LF + DE75 + C7560

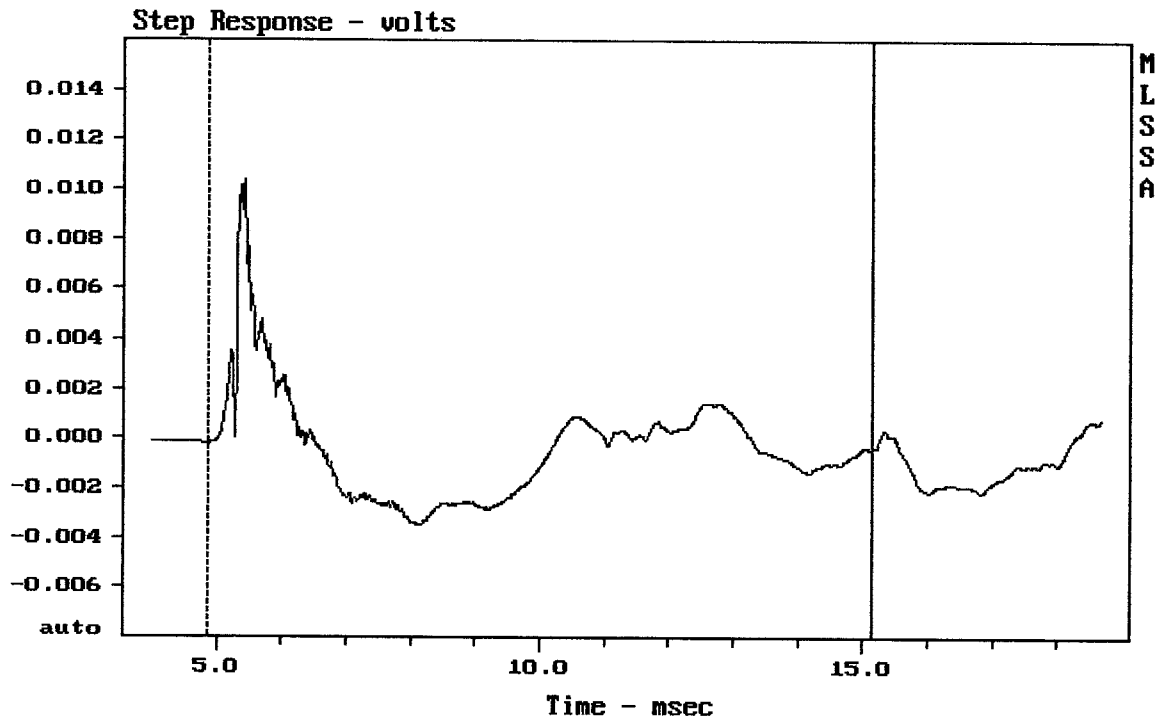



---

mean: -0.0004008, rms: 0.002174, std: 0.002136, max: 0.01036, min: -0.003486

---

EMINENCE KAPPA 15LF + DE75 + C7560

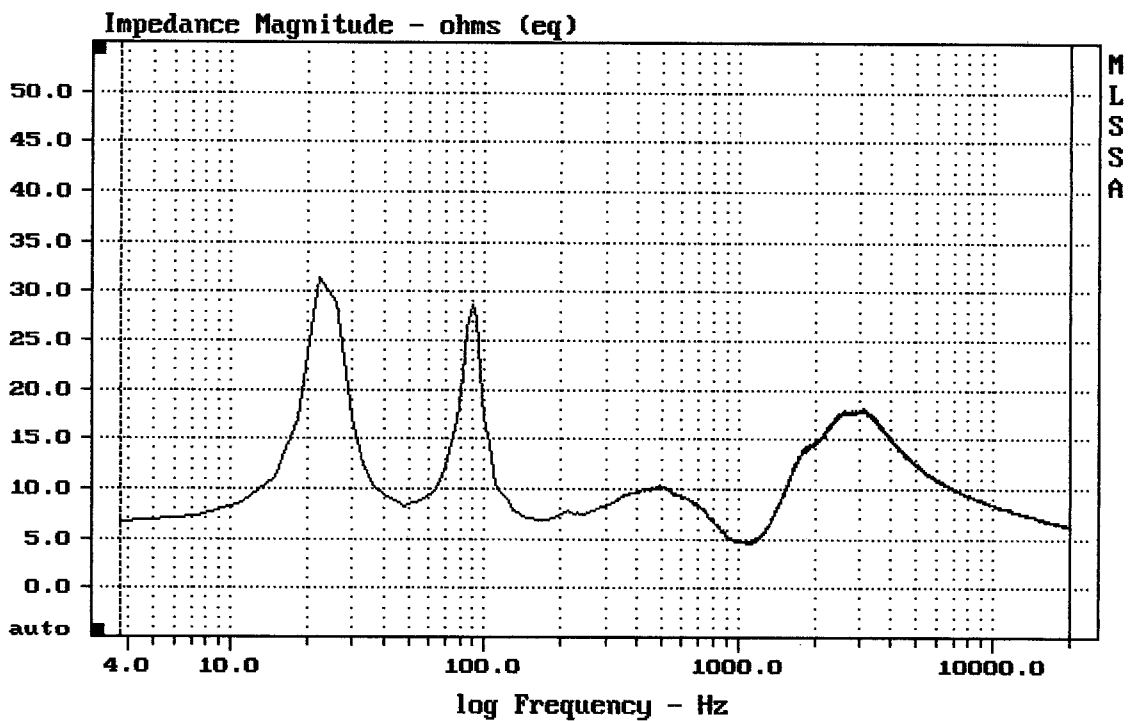
MLSSA: Time Domain





---

mean: 9.302, rms: 9.869, std: 3.299, max: 31.52, min: 4.593

---

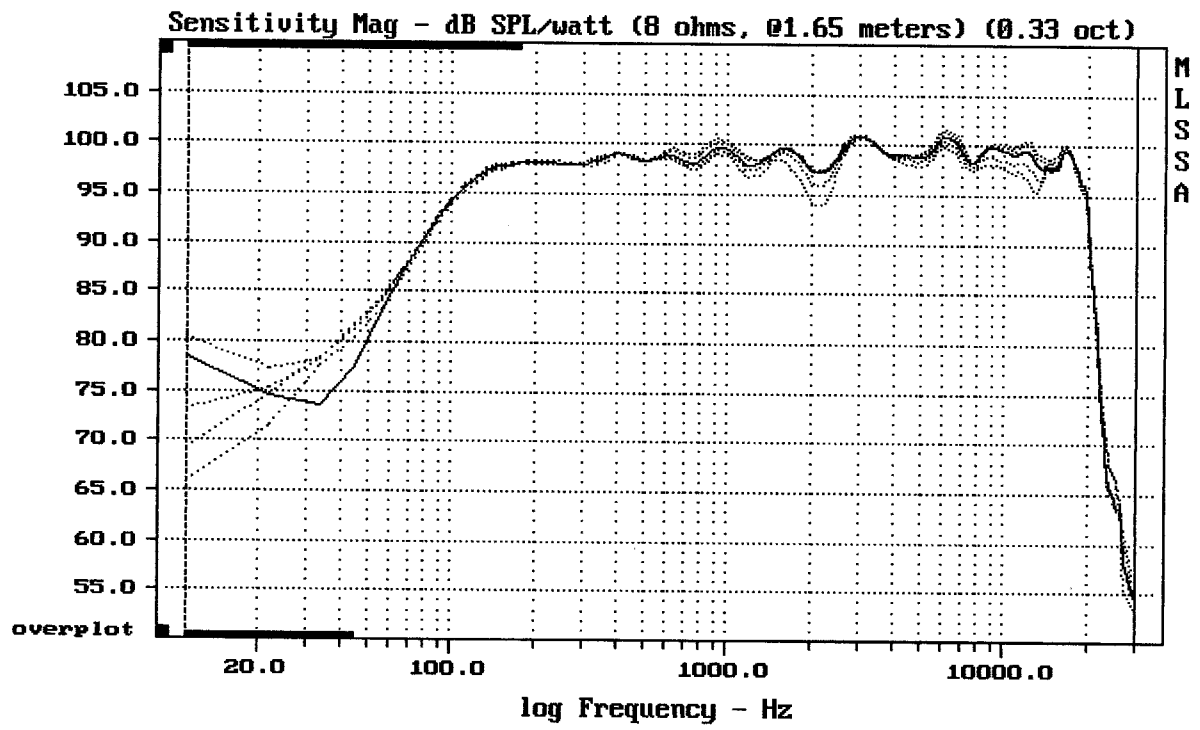
EMINENCE KAPPA 15LF + DE75 + C7560



---

CURSOR: y = 52.7789 x = 30007.1014 (2704)

---

EMINENCE KAPPA 15F + DE75 + C7560

MLSSA: Frequency Domain