

## Sestava B&C Speakers 12HPL64 + DE160 + Megaton A9090

### Osazení:

- B&C Speakers 12HPL64 8/Ohm  
<http://eshop.prodance.cz/DetailPage.asp?DPG=82706>
- B&C Speakers DE160 8/Ohm  
<http://eshop.prodance.cz/DetailPage.asp?DPG=82300>
- Megaton A9090  
<http://eshop.prodance.cz/DetailPage.asp?DPG=83920>

### Schéma výhybky:

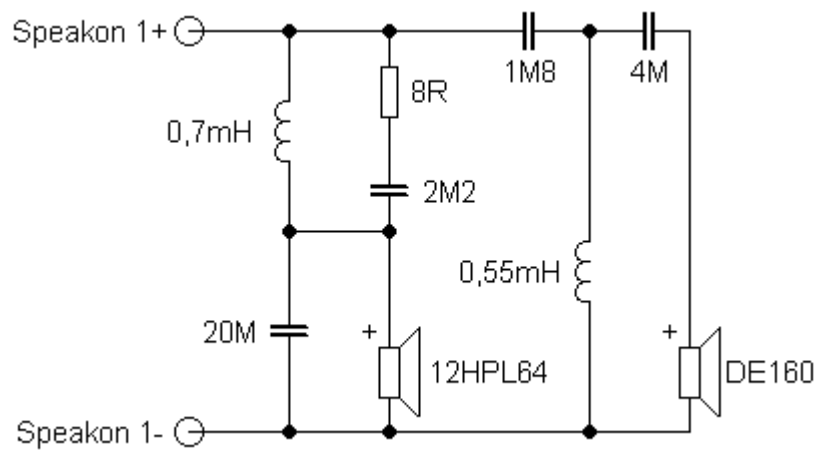

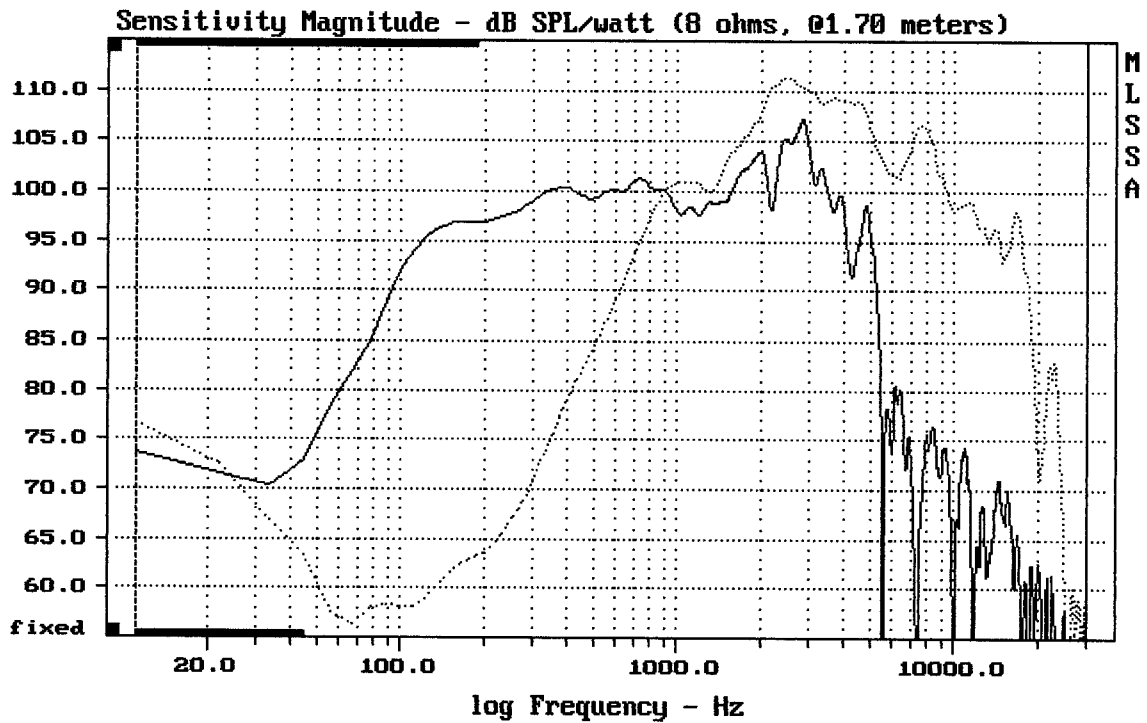

CURSOR: dy = 9.68911 x = 30007.1014 (2704)

12HPL64 + DE160 + A9090

MLSSA: Frequency Domain

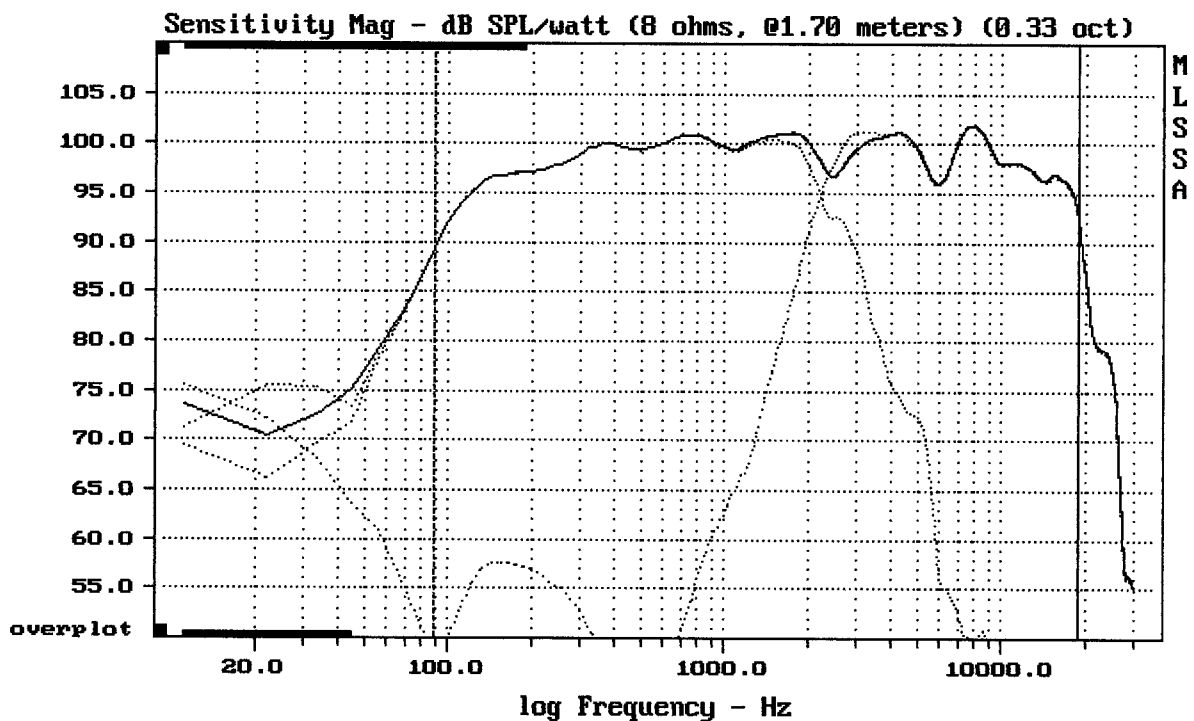

Level (89:19010 Hz) = 99.05 dB SPL/watt (8 ohms, @1.70 meters) (0.33 oct)

12HPL64 + DE160 + A9090

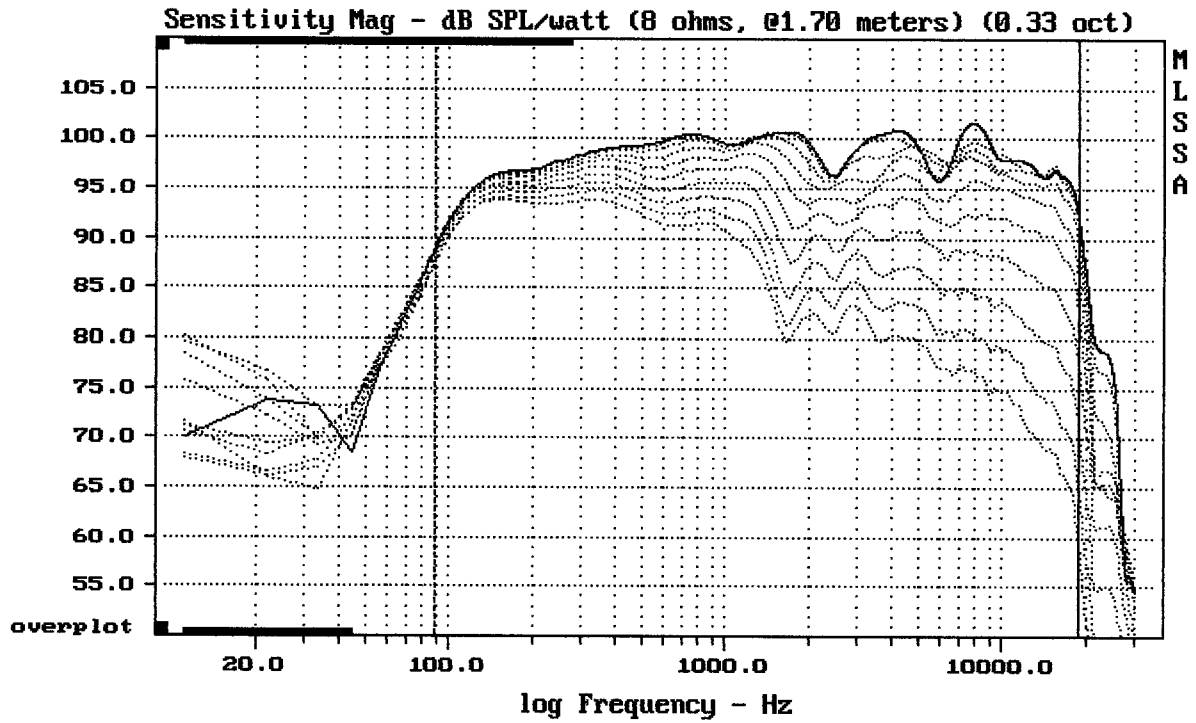



---

Overlay Compare: dev= +22/-9.5, std= 6, avg= -23

---

12HPL64 + DE160 + A9090

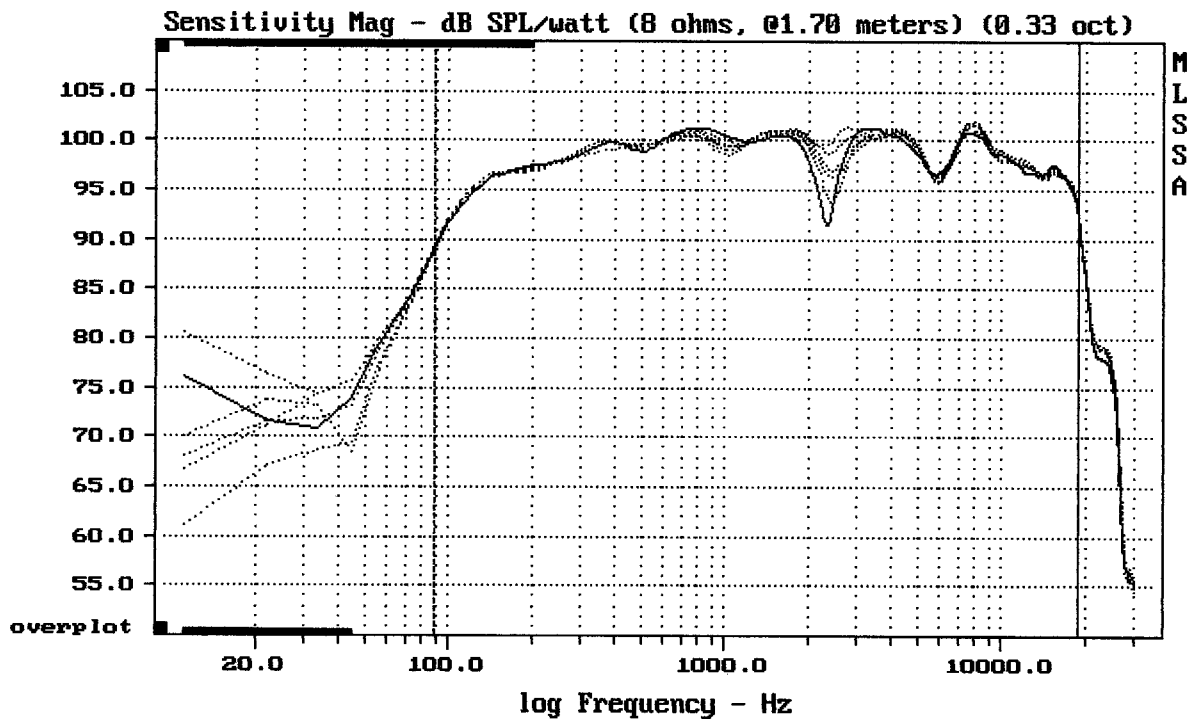
MLSSA: Frequency Domain





---

mean: 98.45, rms: 98.67, std: 1.78, max: 101.40, min: 89.52

---

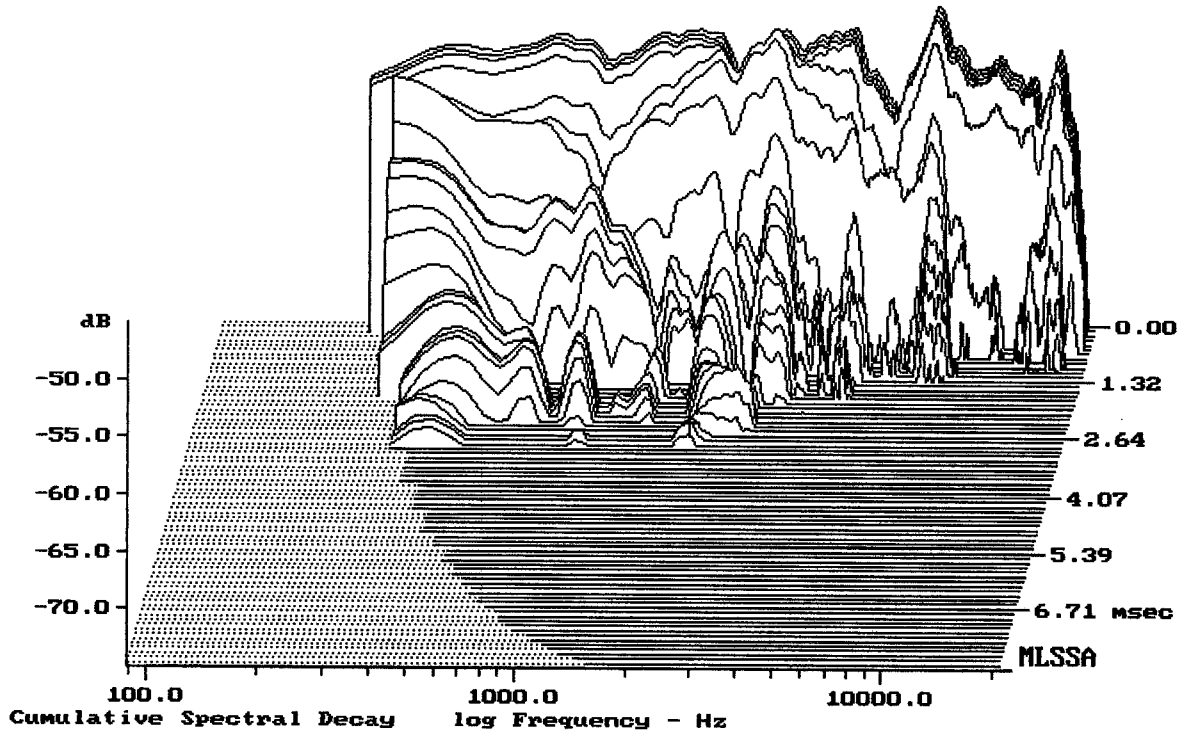
12HPL64 + DE160 + A9090



-73.48 dB, 1998 Hz (45), 2.750 msec (26)

DTTO

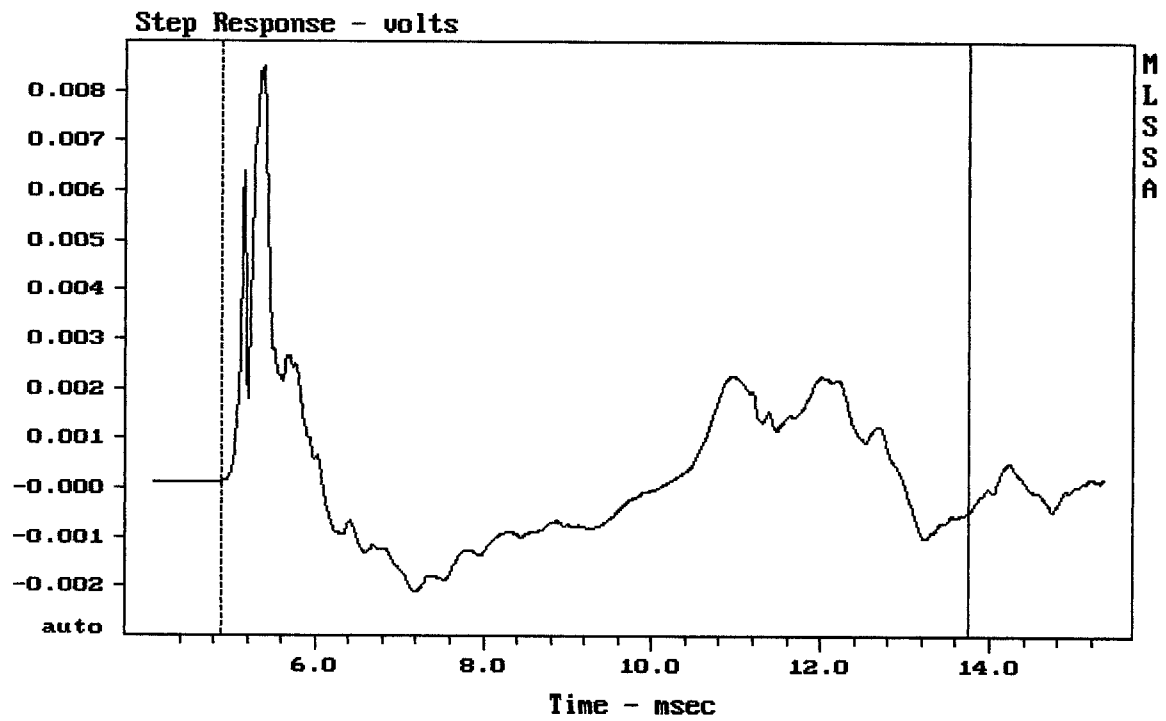

mean: 0.0002924, rms: 0.001775, std: 0.00175, max: 0.008508, min: -0.002113

12HPL64 + DE160 + A9090

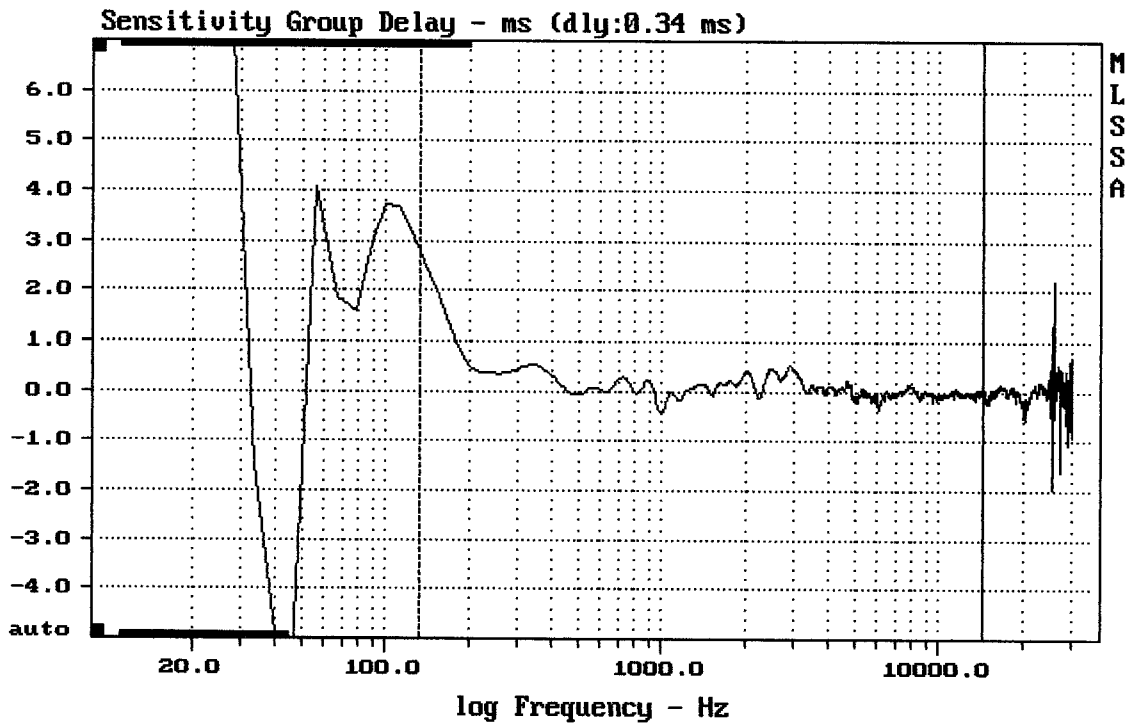



---

mean: 0.02285, rms: 0.1962, std: 0.1948, max: 2.773, min: -0.4559

---

12HPL64 + DE160 + A9090

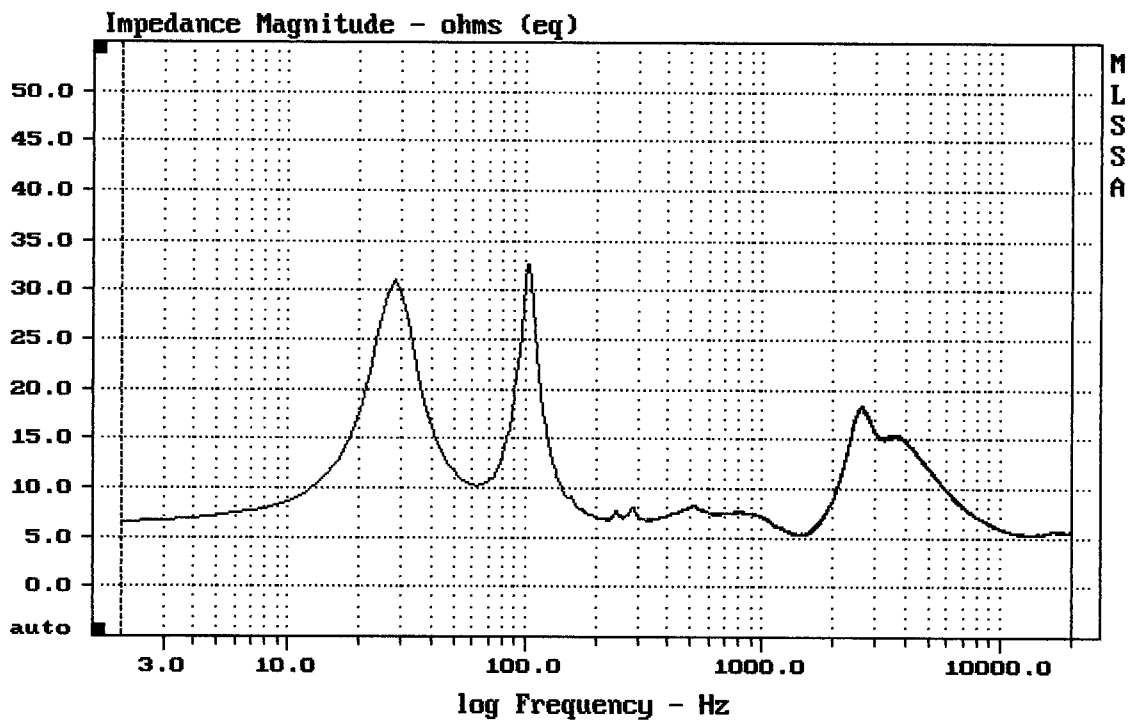
MLSSA: Frequency Domain



---

mean: 7.735, rms: 8.474, std: 3.463, max: 32.56, min: 5.254

---

12HPL64 + DE160 + A9090