

Sestava B&C Speakers 12HPL76 + 12MH32 + DE82TN + ME90

Osazení:

- B&C Speakers 12HPL76 8/Ohm
<http://eshop.prodance.cz/DetailPage.asp?DPG=82710>
- B&C Speakers 12MH32 8/Ohm
<http://eshop.prodance.cz/DetailPage.asp?DPG=82718>
- B&C Speakers DE82TN 8/Ohm
<http://eshop.prodance.cz/DetailPage.asp?DPG=92772>
- B&C Speakers ME90
<http://eshop.prodance.cz/DetailPage.asp?DPG=80246>

Schéma výhybky:

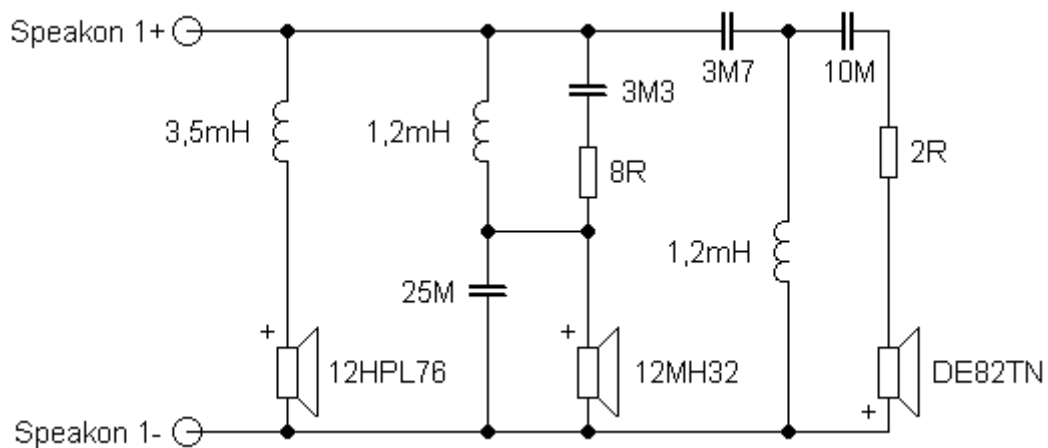

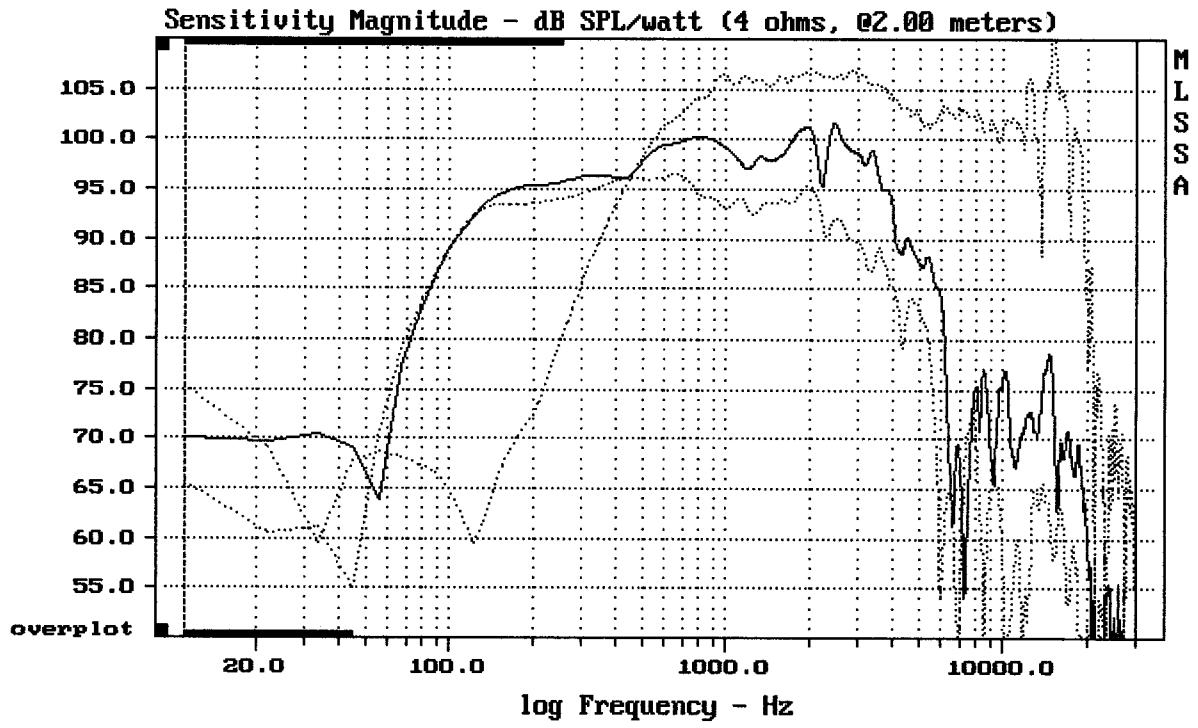

CURSOR: y = 42.0409 x = 30007.1014 (2704)

12HPL76 + 12MH32 + DE82 + ME90

MLSSA: Frequency Domain

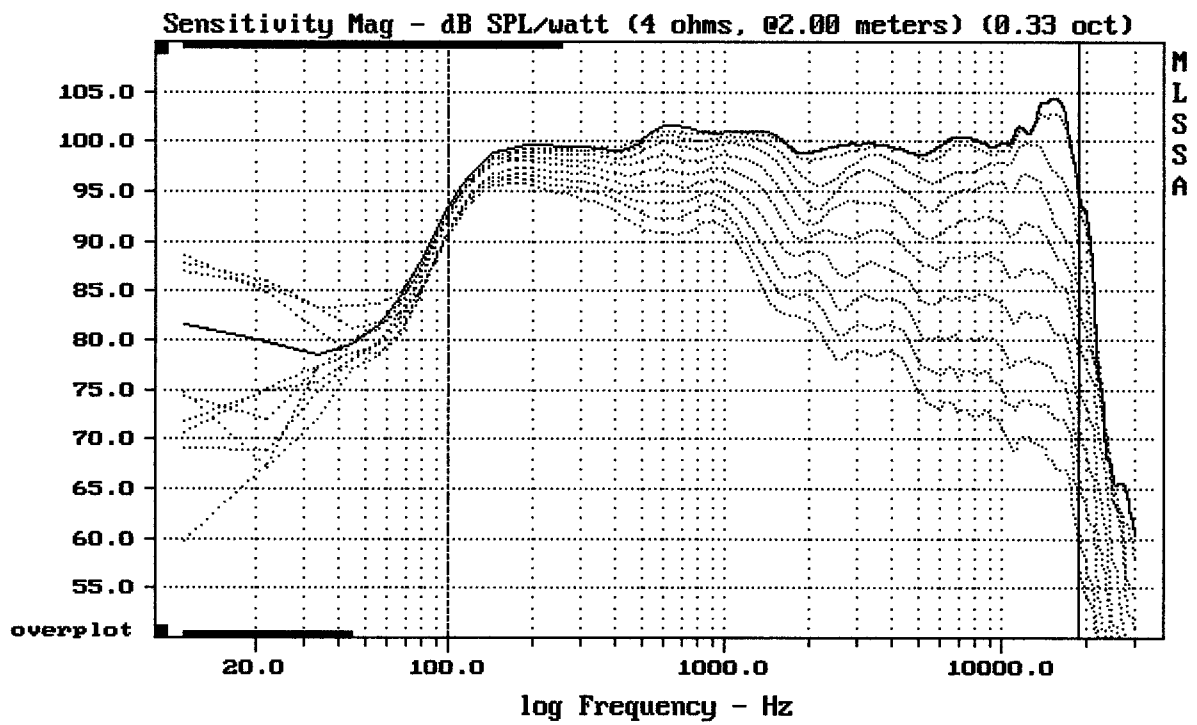

Overlay Compare: dev= +25/-9.6, std= 7.6, avg= -28

12HPL76 + 12MH32 + DE82 + ME90

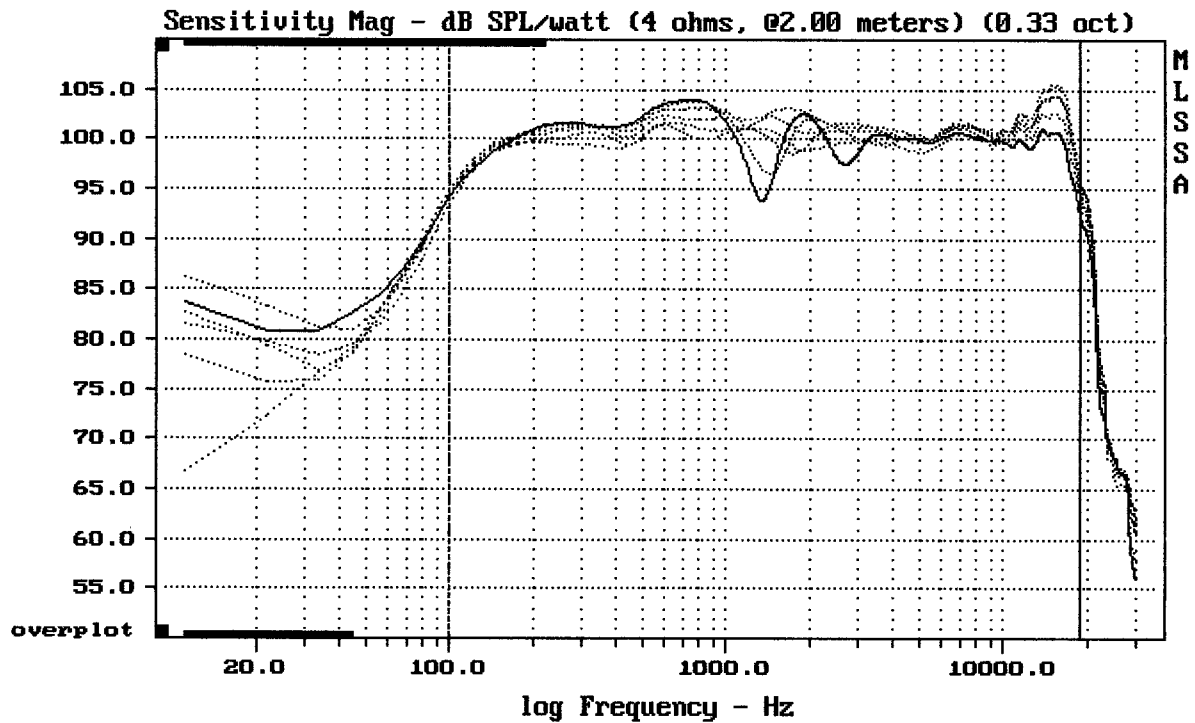

Overlay Compare: dev= +2.9/-2.2, std= 0.6, avg= 1.1

12HPL76 + 12MH32 + DE82 + ME90

MLSSA: Frequency Domain

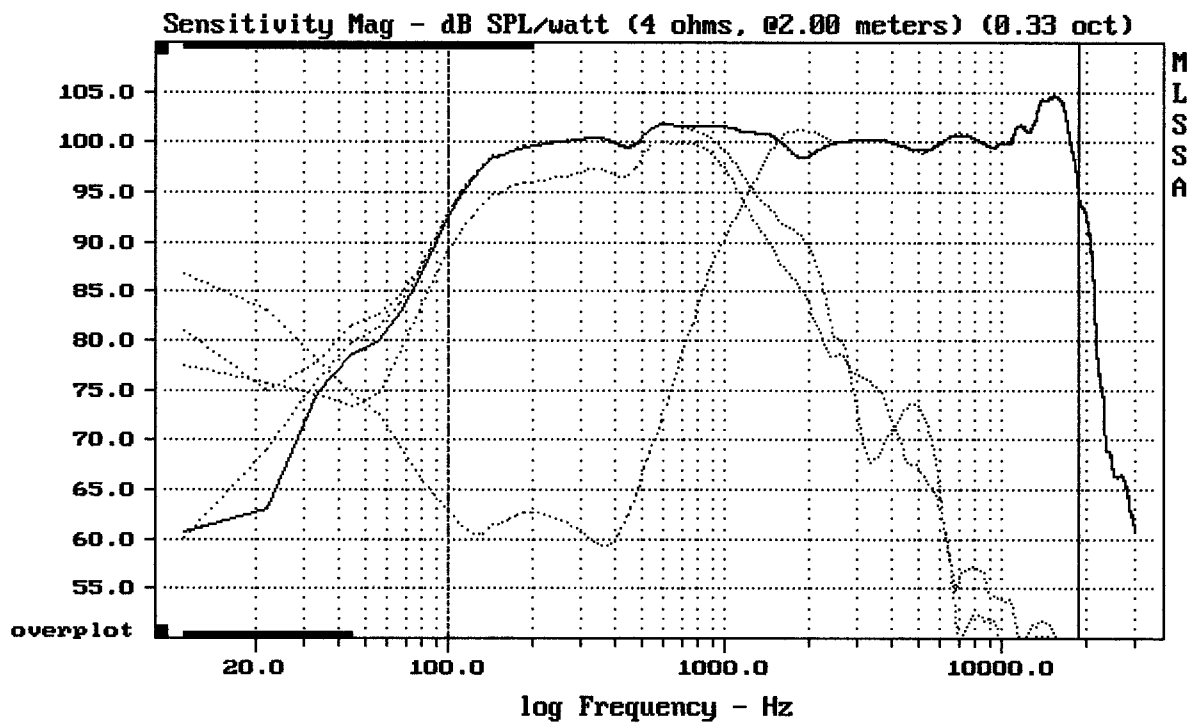

Level (100:19010 Hz) = 100.39 dB SPL/watt (4 ohms, @2.00 meters) (0.33 oct)

12HPL76 + 12MH32 + DE82 + ME90

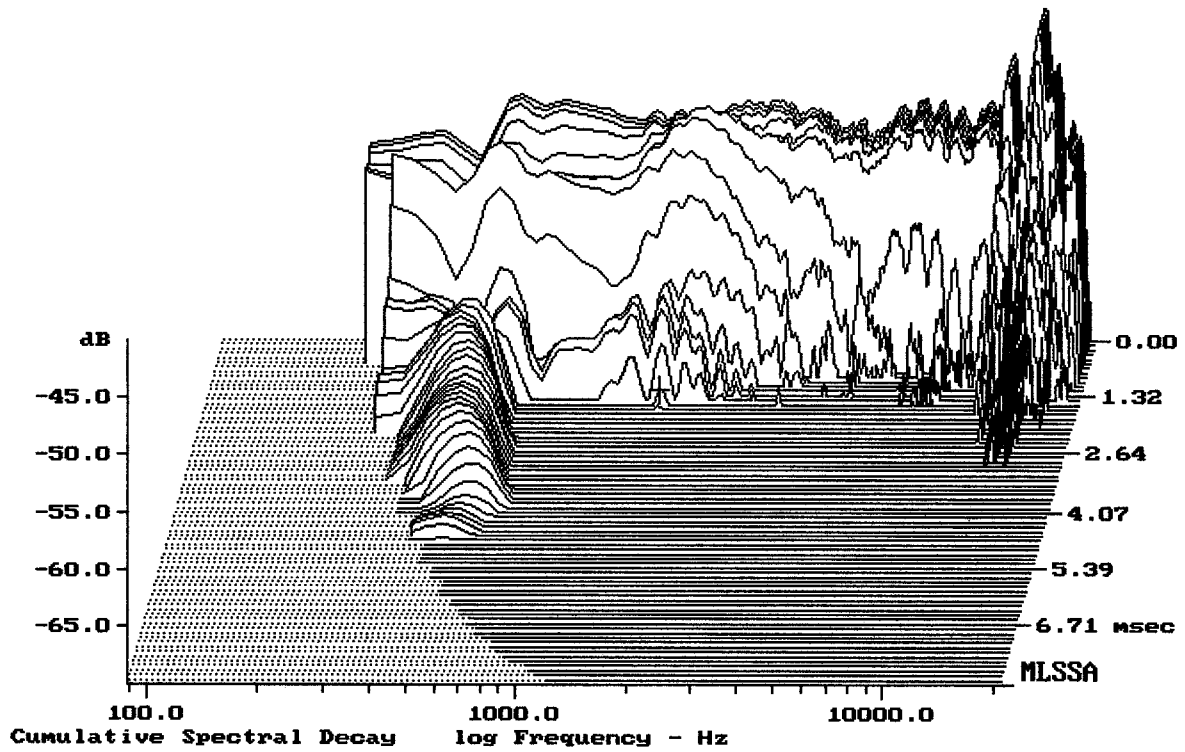

-68.64 dB, 1509 Hz (34), 1.540 msec (15)

DTTO

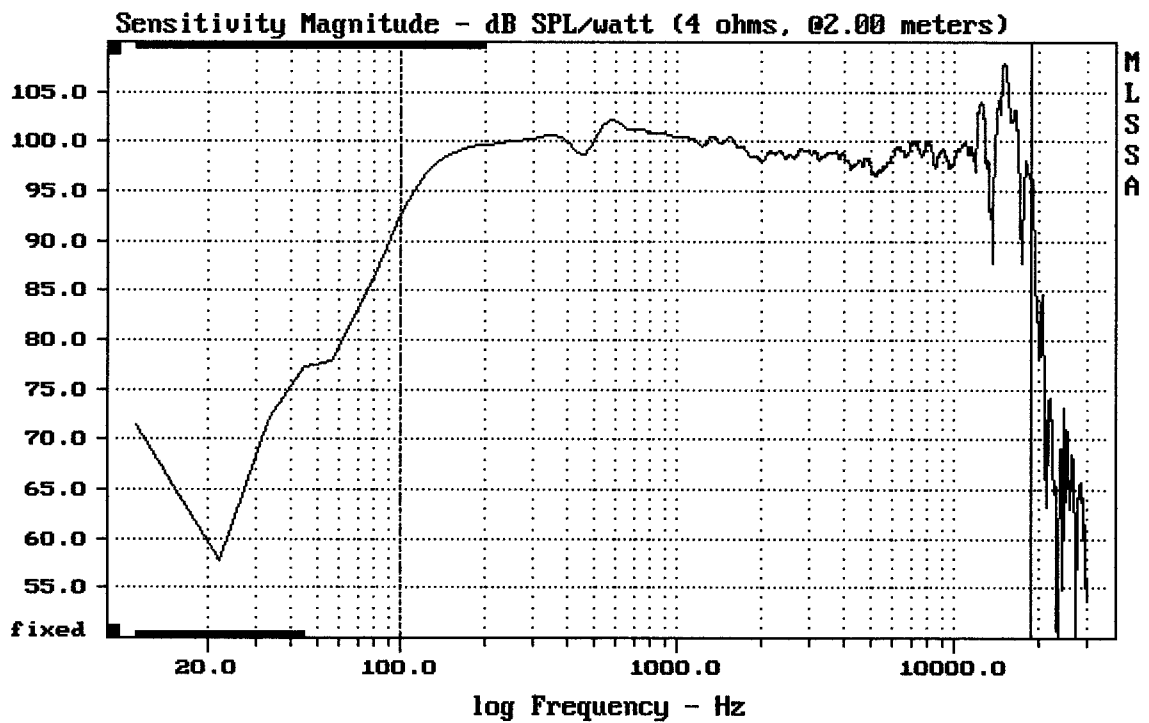

Level (100:19010 Hz) = 99.76 dB SPL/watt (4 ohms, @2.00 meters)

12HPL76 + 12MH32 + DE82 + ME90

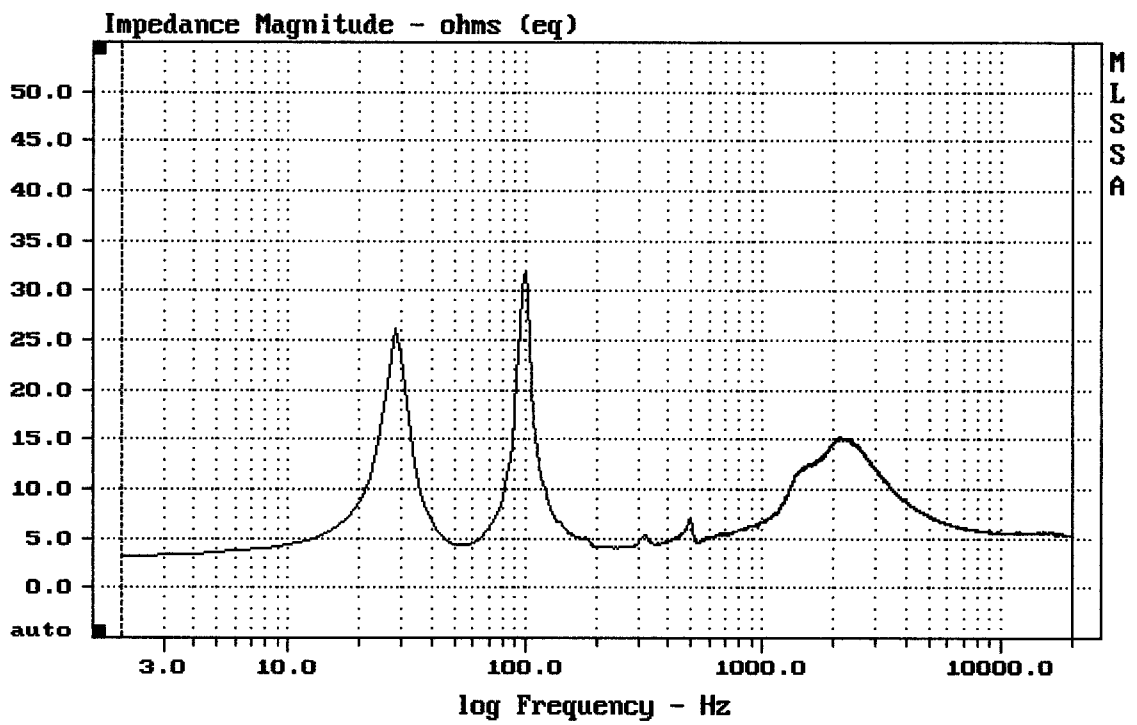

mean: 6.731, rms: 7.183, std: 2.508, max: 32.08, min: 3.273

12HPL76 + 12MH32 + DE82 + ME90