

Sestava B&C Speakers 12NW76 + DE610 + Megaton B9070

Osazení:

- B&C Speakers 12NW76 8/Ohm
<http://eshop.prodance.cz/DetailPage.asp?DPG=82730>
- B&C Speakers DE610 8/Ohm
<http://eshop.prodance.cz/DetailPage.asp?DPG=82315>
- Megaton B9070
<http://eshop.prodance.cz/DetailPage.asp?DPG=84263>

Schéma výhybky:

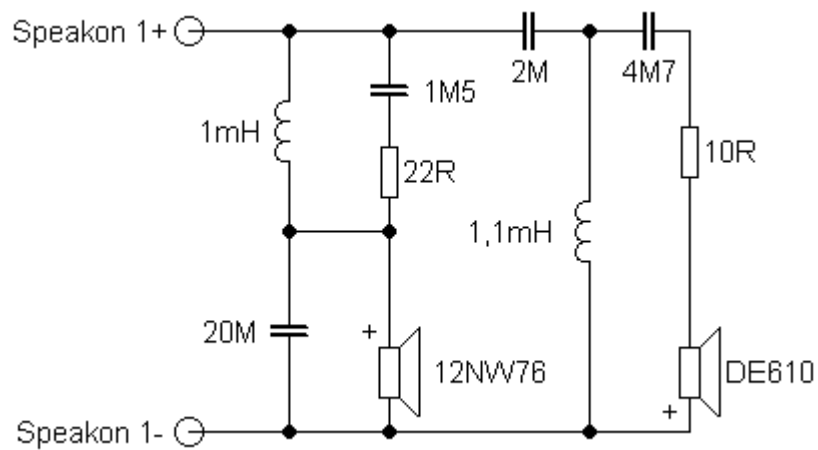

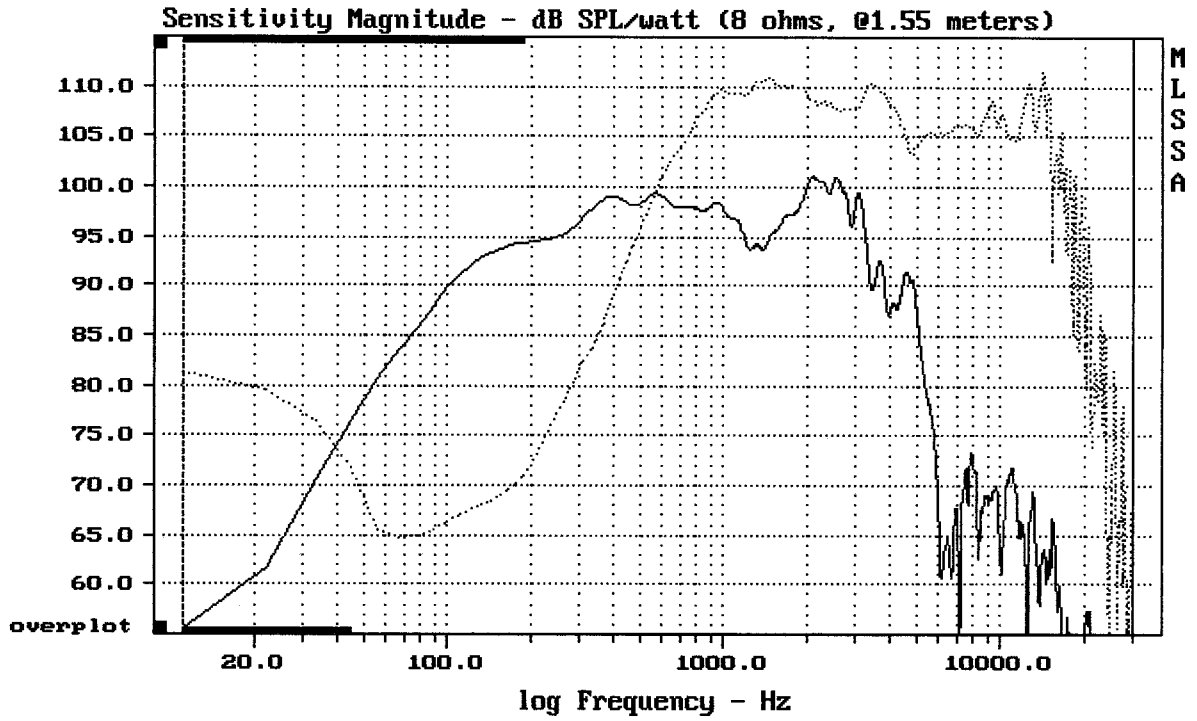

CURSOR: y = 52.0595 x = 30007.1014 (2704)

12NW76 + DE610 + B9070

MLSSA: Frequency Domain

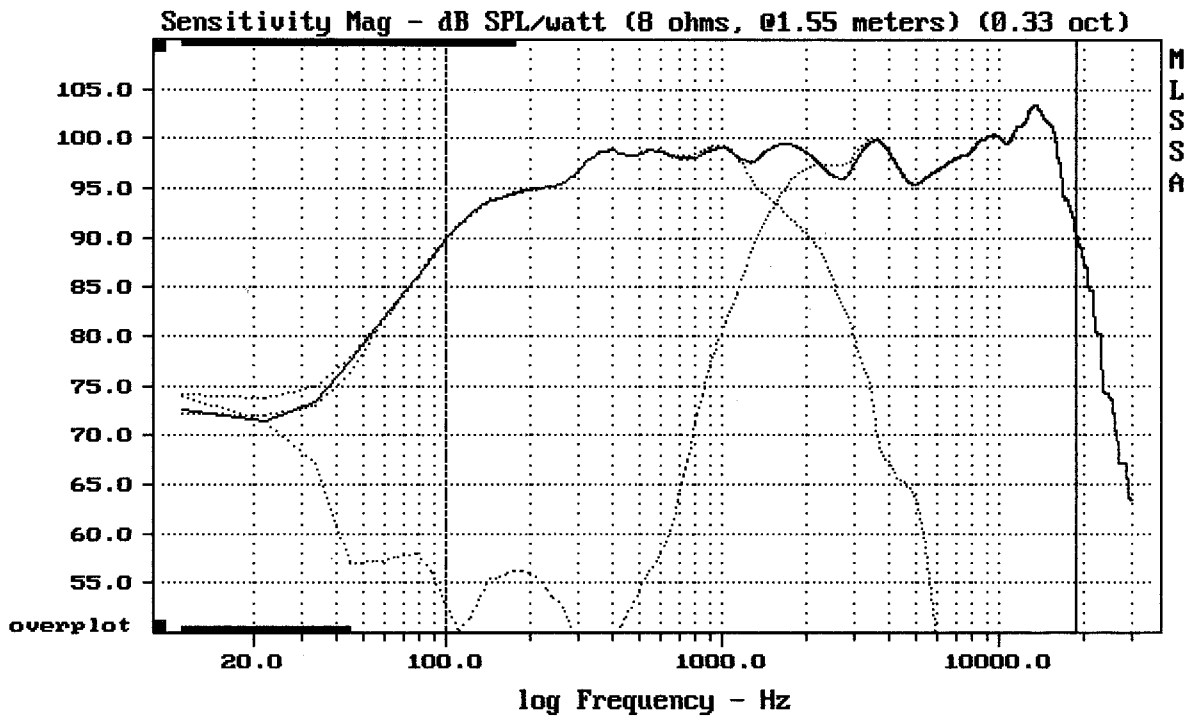

Level (100:19010 Hz) = 98.06 dB SPL/watt (8 ohms, @1.55 meters) (0.33 oct)

12NW76 + DE610 + B9070

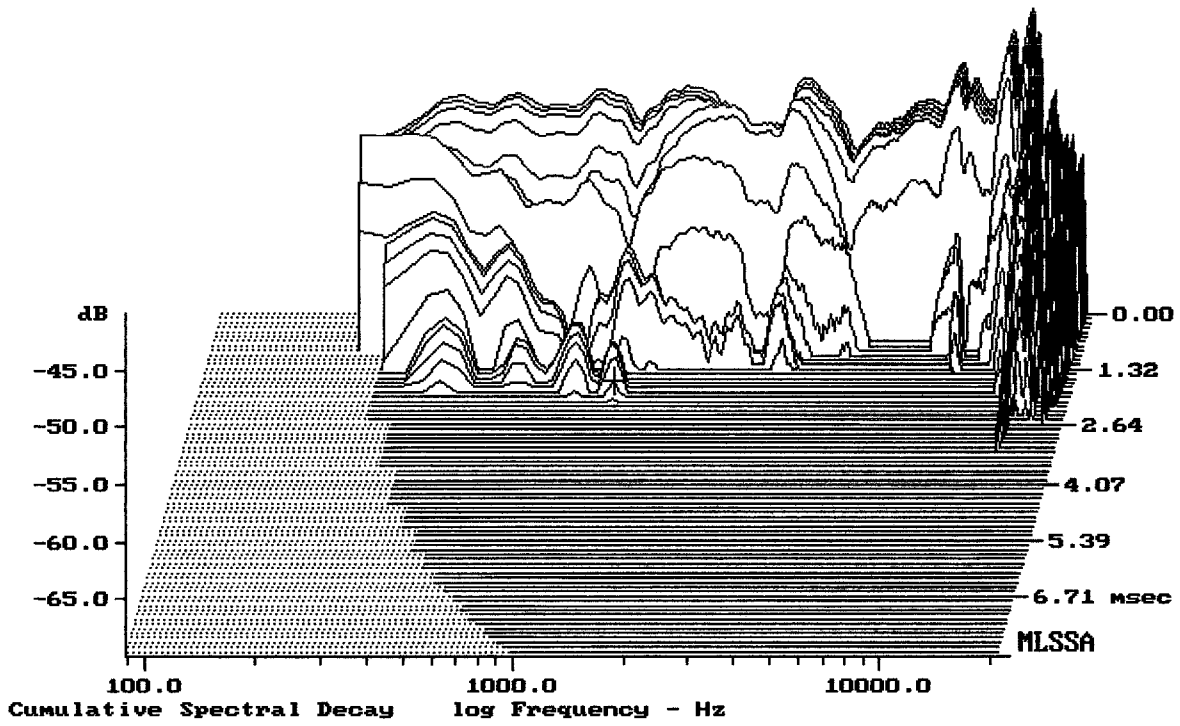

-68.65 dB, 1199 Hz (27), 1.980 msec (19)

DTTO

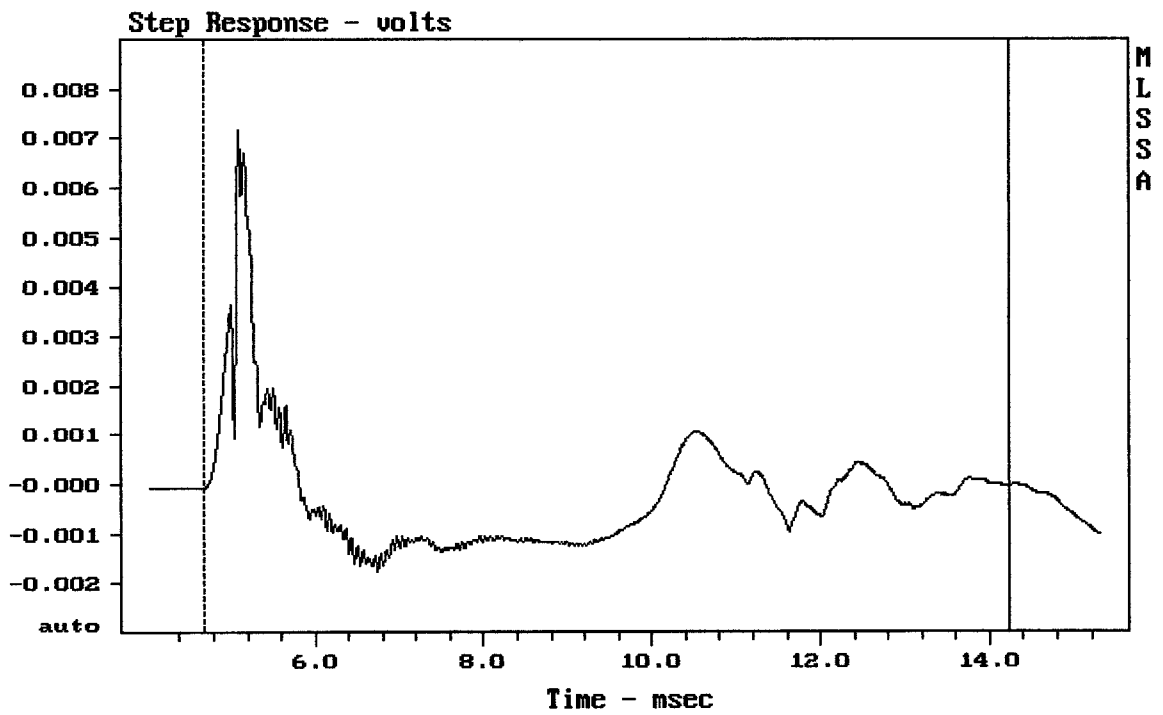

mean: -0.0002223, rms: 0.001265, std: 0.001245, max: 0.007187, min: -0.00175

12NW76 + DE610 + B9070

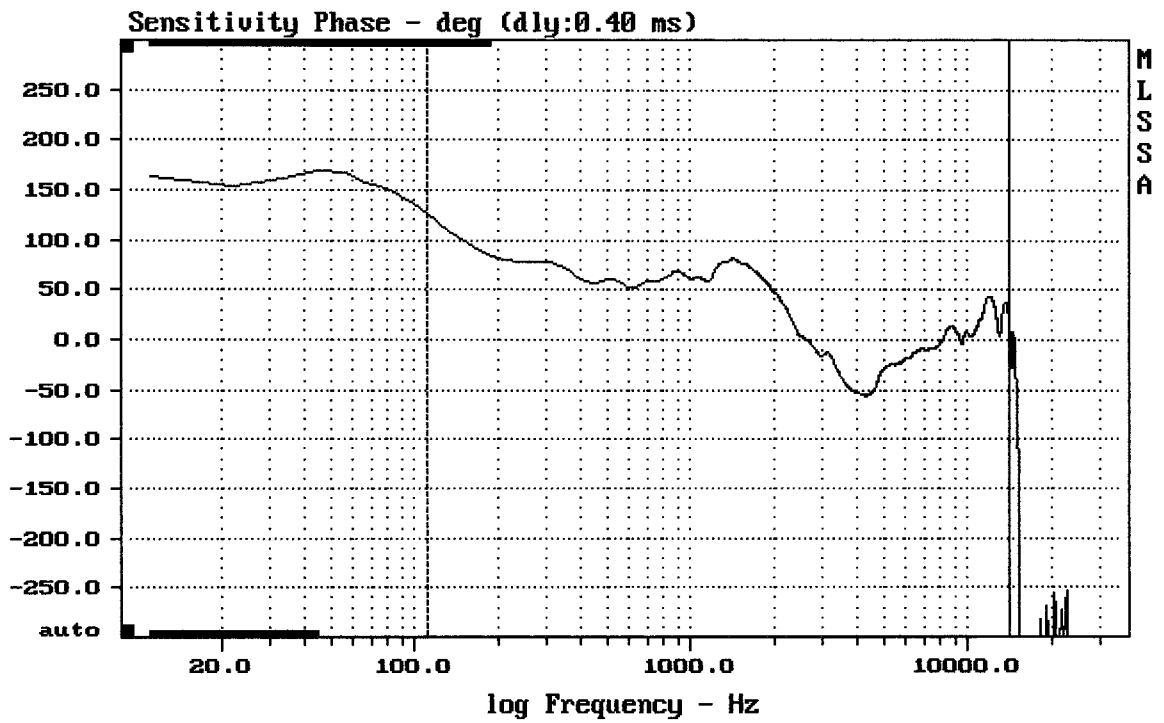

mean: 9.102, rms: 34.89, std: 33.68, max: 126.8, min: -56.78

12NW76 + DE610 + B9070

MLSSA: Frequency Domain

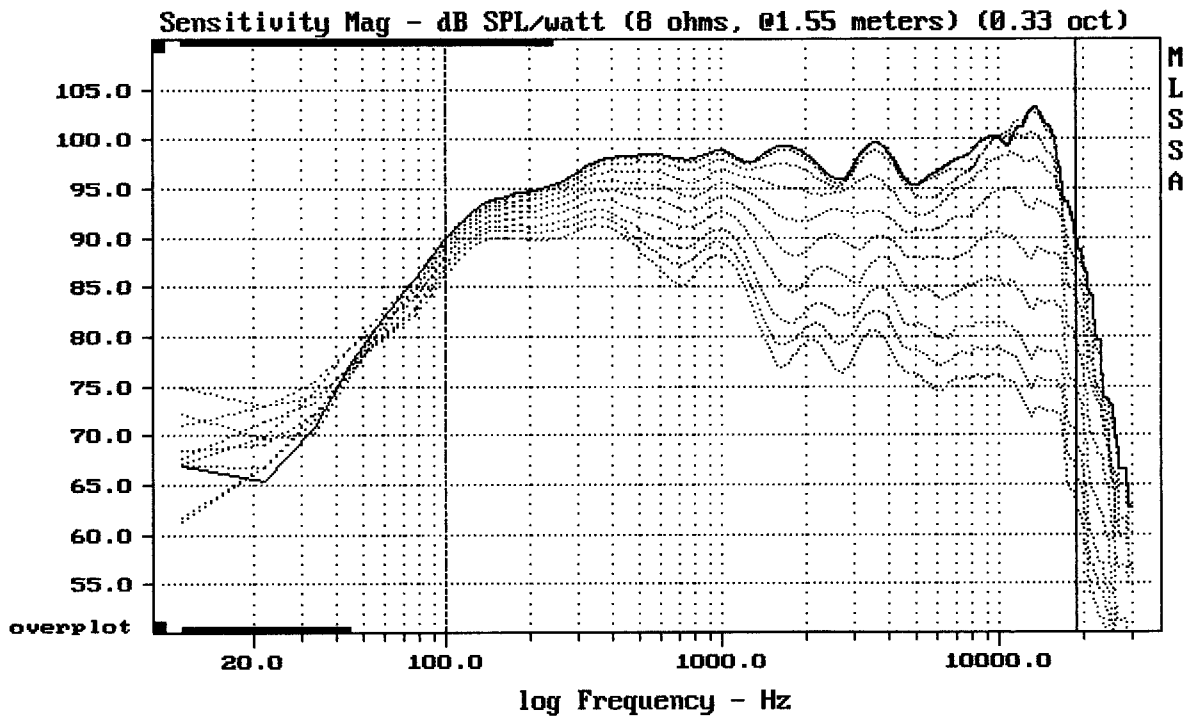

Overlay Compare: dev= +20/-7.7, std= 5.1, avg= -23

12NW76 + DE610 + B9070

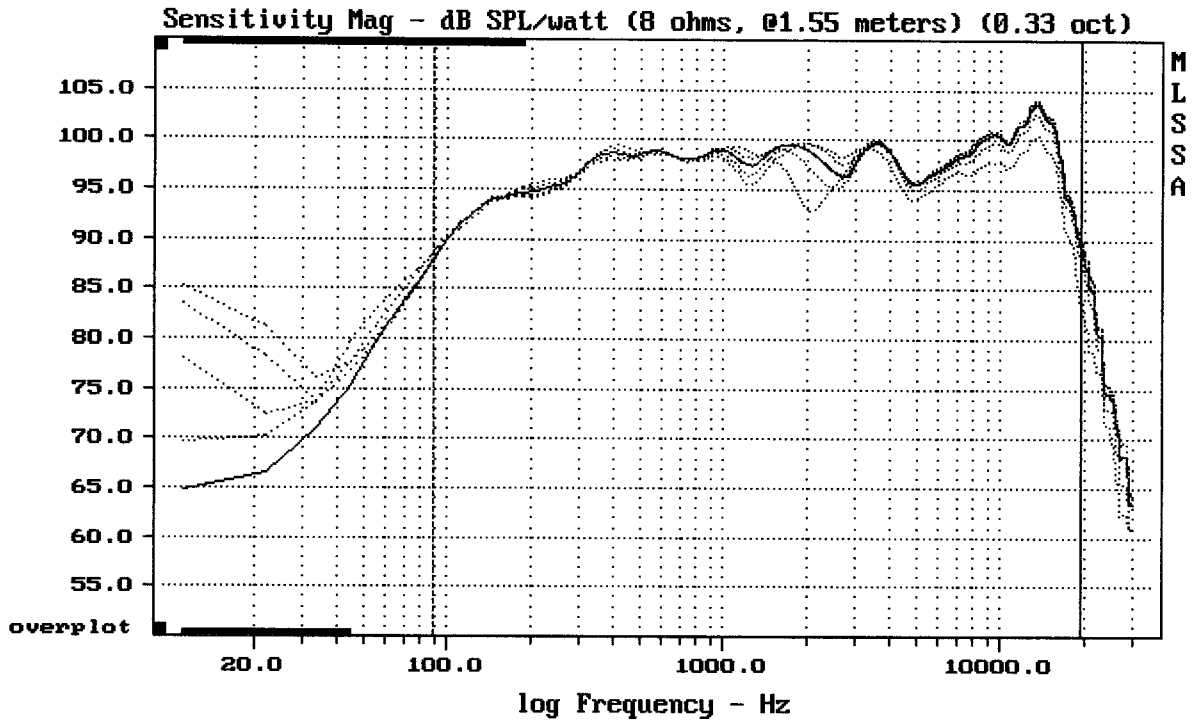

12NW76 + DE610 + B9070

MLSSA: Frequency Domain

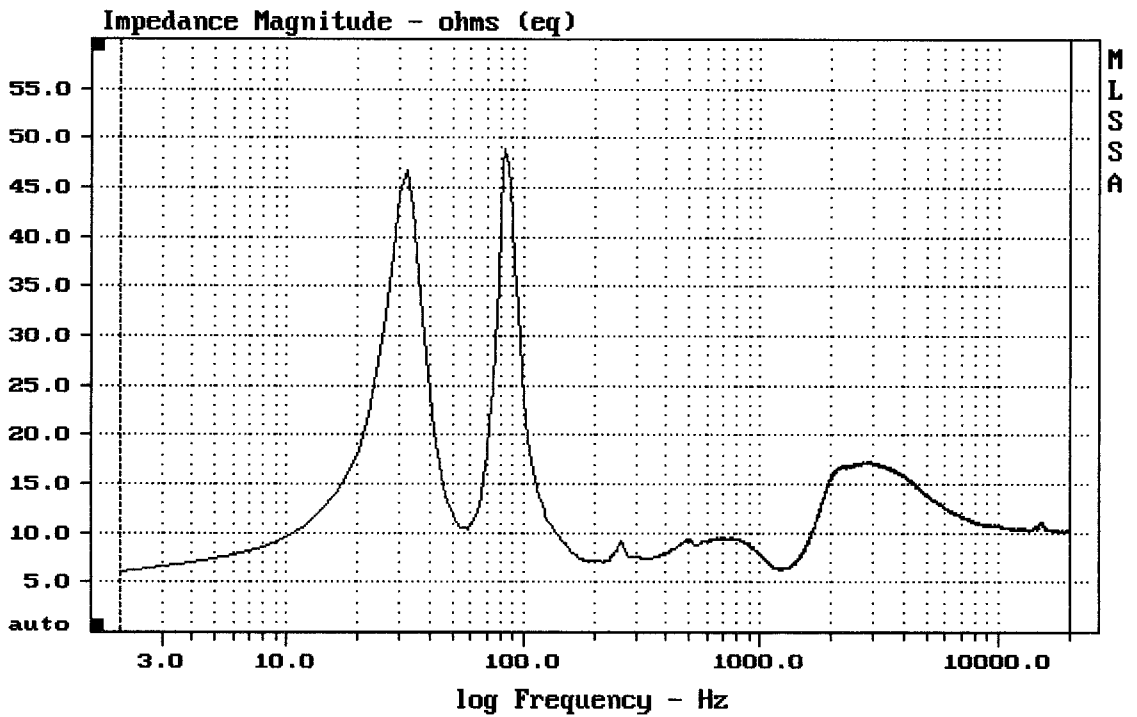

12NW76 + DE610 + B9070