

Sestava B&C Speakers 15HPL76/4 + RCF ND1710MT3 + Megaton A1160

Osazení:

- B&C Speakers 15HPL76/4 4/Ohm
<http://eshop.prodance.cz/DetailPage.asp?DPG=82843>
- RCF ND1710MT3 8/Ohm
<http://eshop.prodance.cz/DetailPage.asp?DPG=78907>
- Megaton A1160
<http://eshop.prodance.cz/DetailPage.asp?DPG=83839>

Schéma výhybky:

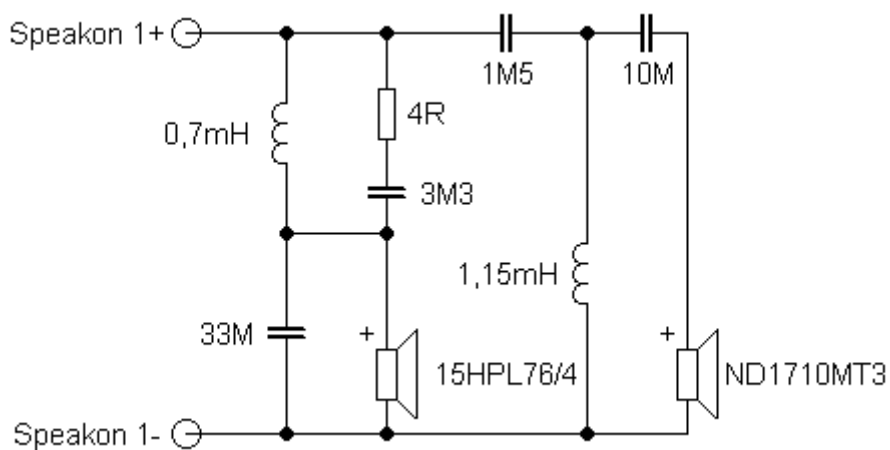

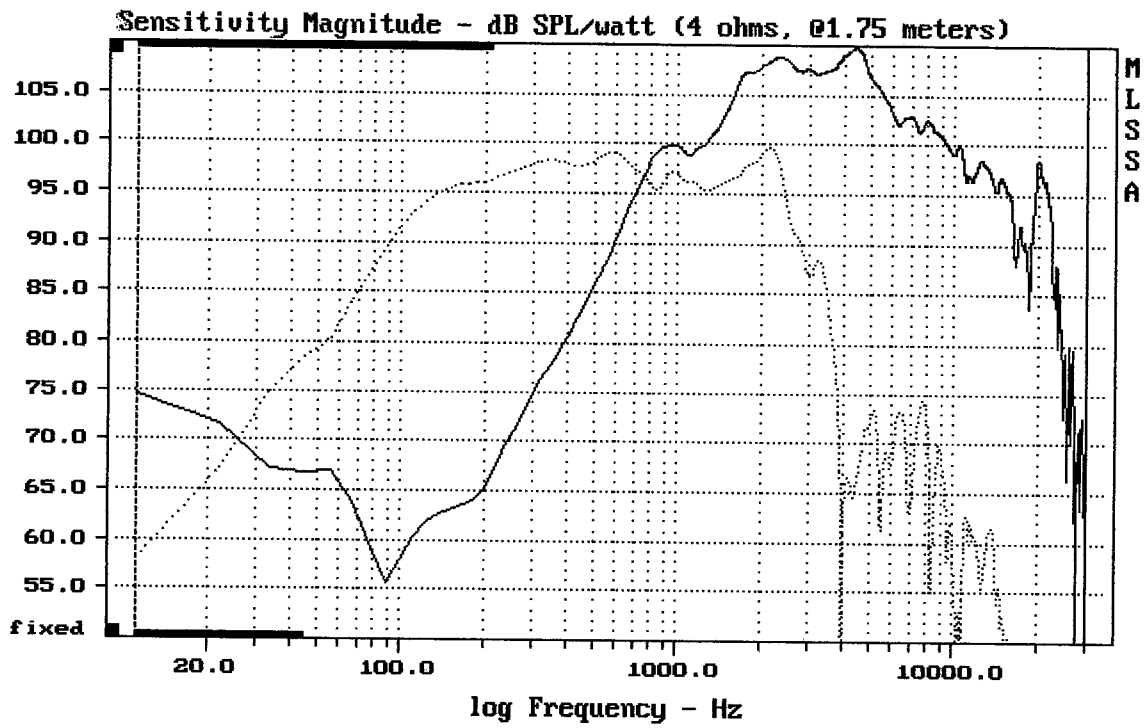

CURSOR: $\Delta y = -38.9072$ $x = 30007.1014$ (2704)

15HPL76-4ohm + ND1710MT3 + A1160

MLSSA: Frequency Domain

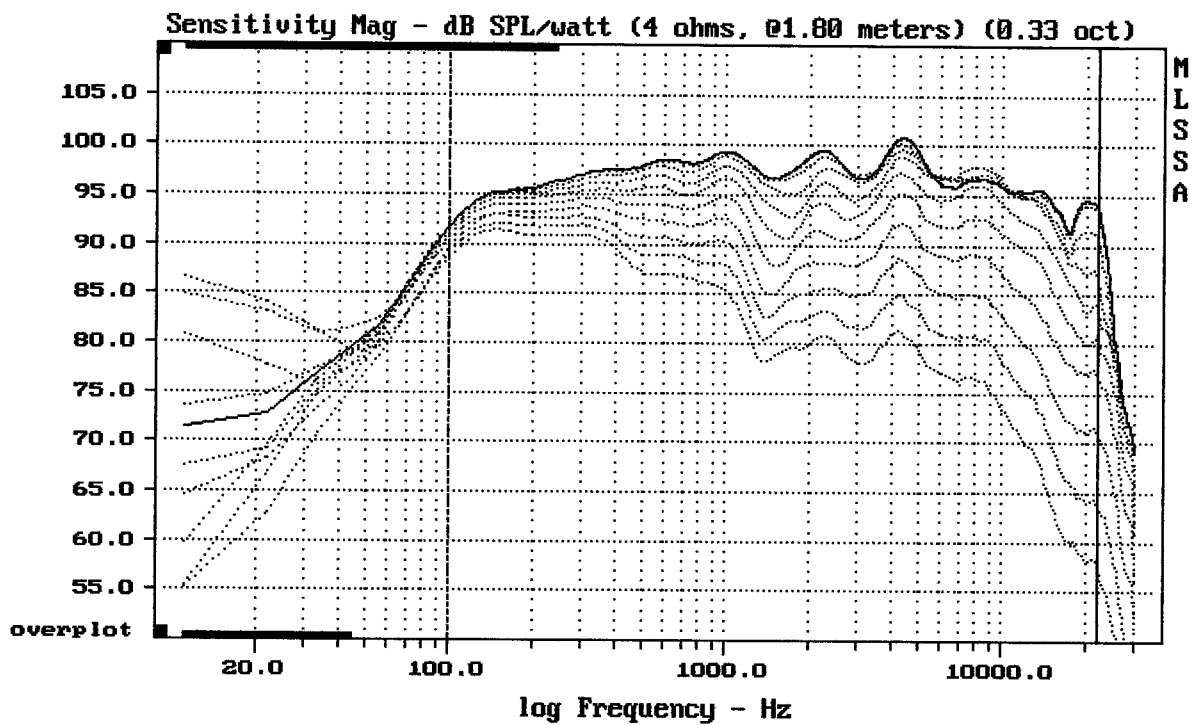

Overlay Compare: $\text{dev} = +22/-11$, $\text{std} = 7.1$, $\text{avg} = -25$

15HPL76-4ohm + ND1710MT3 + A1160

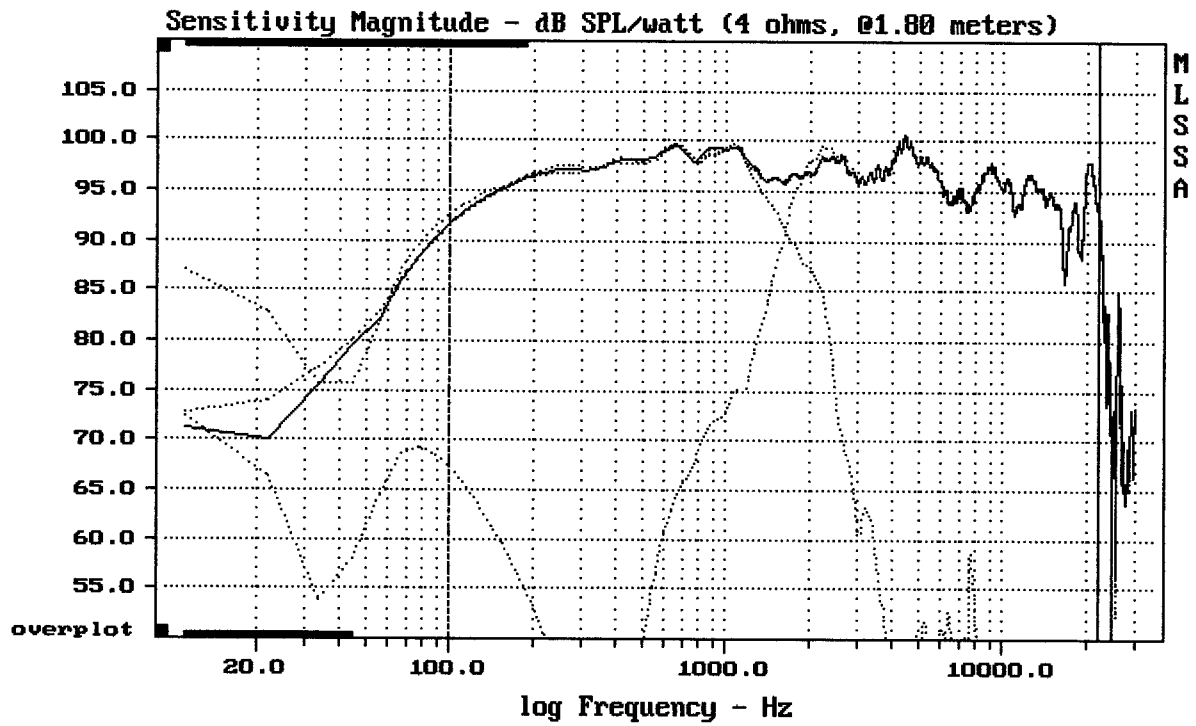

Level (100:22006 Hz) = 96.94 dB SPL/watt (4 ohms, @1.80 meters)

15HPL76-4ohm + ND1710MT3 + A1160

MLSSA: Frequency Domain

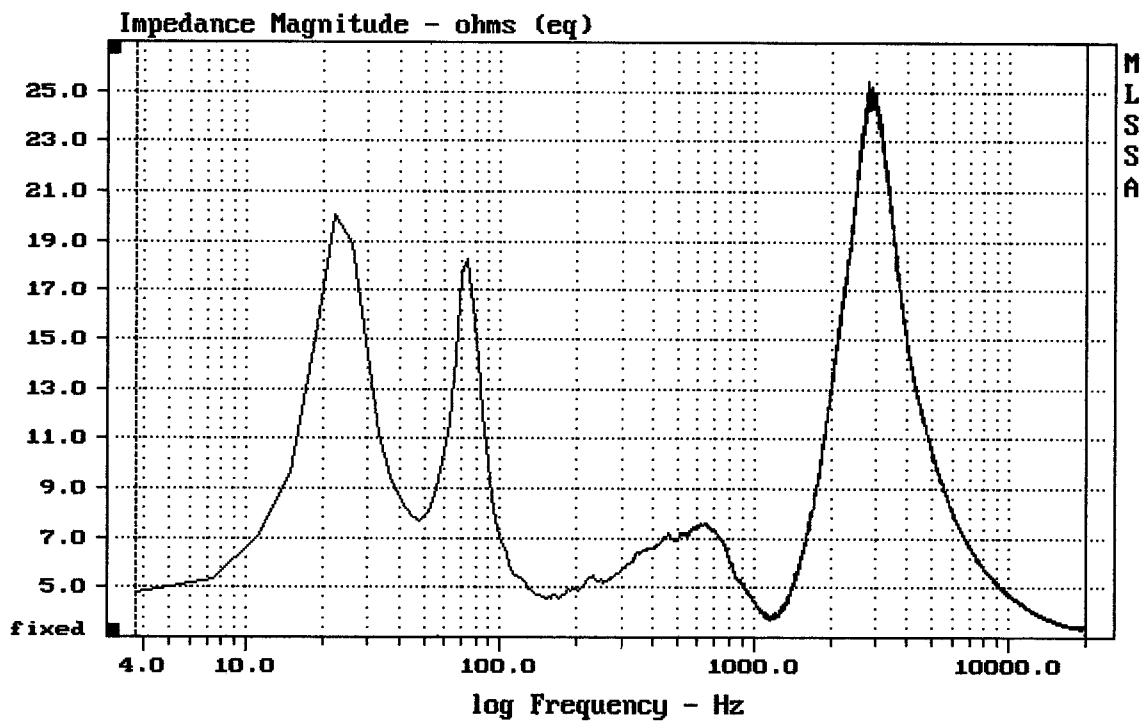

mean: 6.817, rms: 8.503, std: 5.083, max: 25.45, min: 3.32

15HPL76-4ohm + ND1710MT3 + A1160

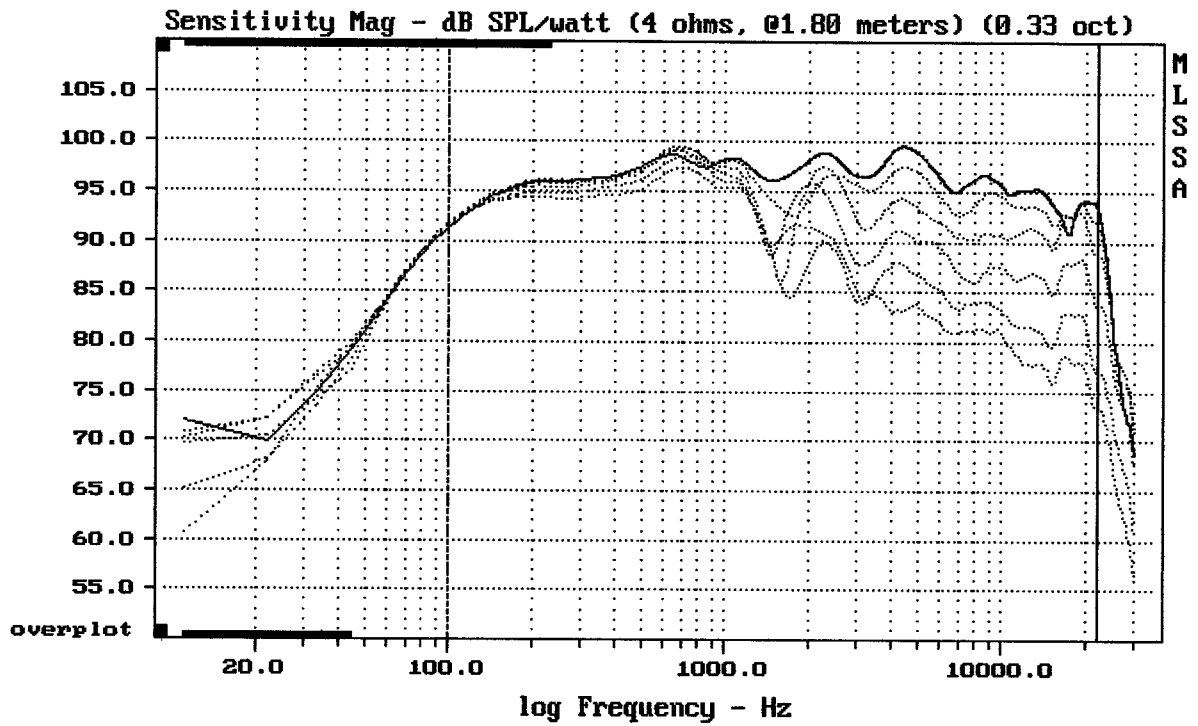

Overlay Compare: dev= +15/-5.9, std= 3.9, avg= -15

15HPL76-4ohm + ND1710MT3 + A1160

0±50° dolů

MLSSA: Frequency Domain

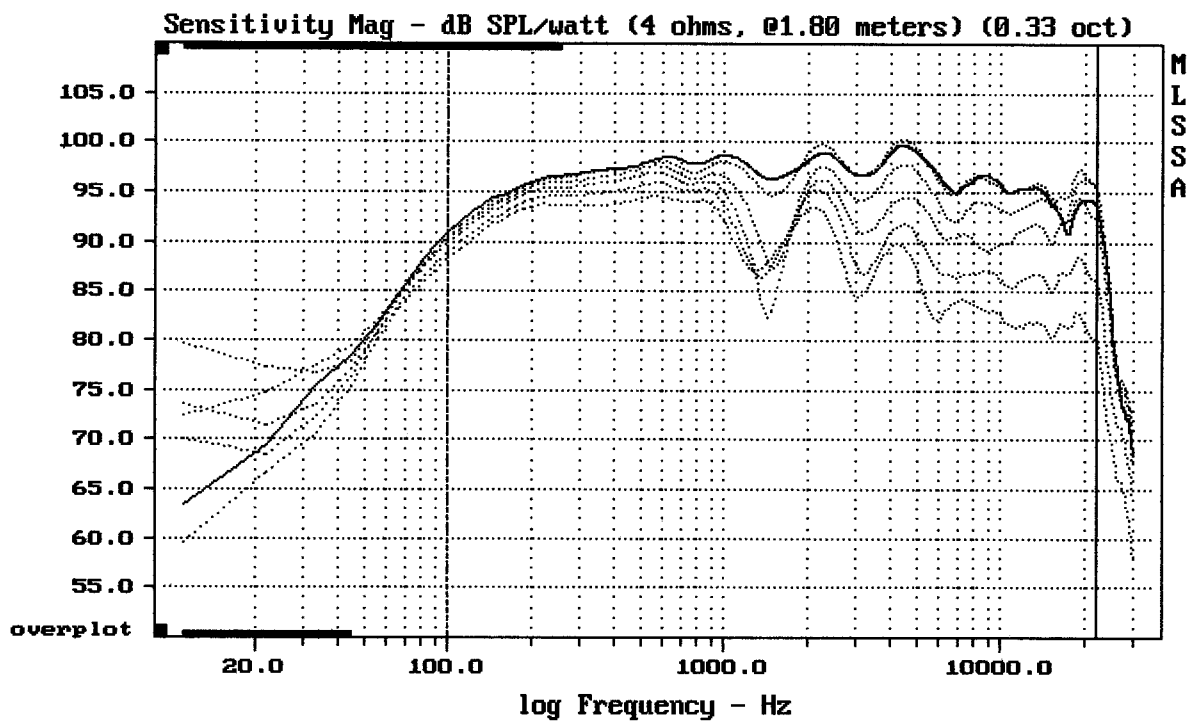

Overlay Compare: dev= +9.2/-3.5, std= 2.6, avg= -12

15HPL76-4ohm + ND1710MT3 + A1160

0±50° nahoru