

## Sestava B&C Speakers 15NDL76 + DE500 + RCF H100

### Osazení:

- B&C Speakers 15NDL76 8/Ohm  
<http://eshop.prodance.cz/DetailPage.asp?DPG=82860>
- B&C Speakers DE500 8/Ohm  
<http://eshop.prodance.cz/DetailPage.asp?DPG=82312>
- RCF H100  
<http://eshop.prodance.cz/DetailPage.asp?DPG=81599>

### Schéma výhybky:

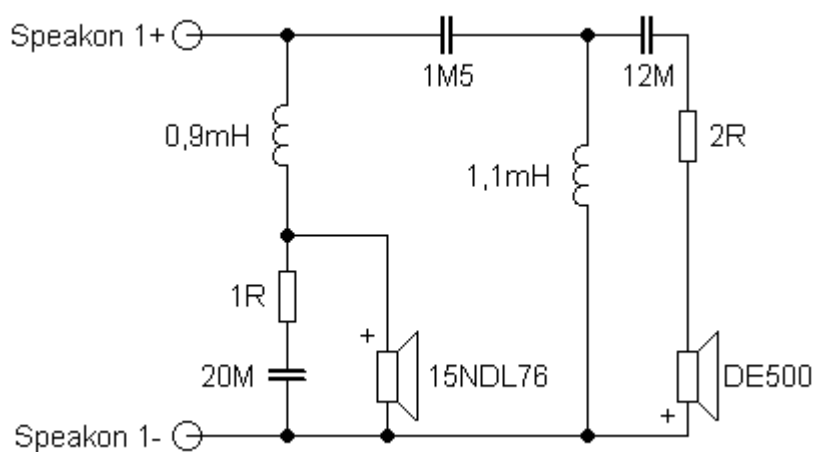

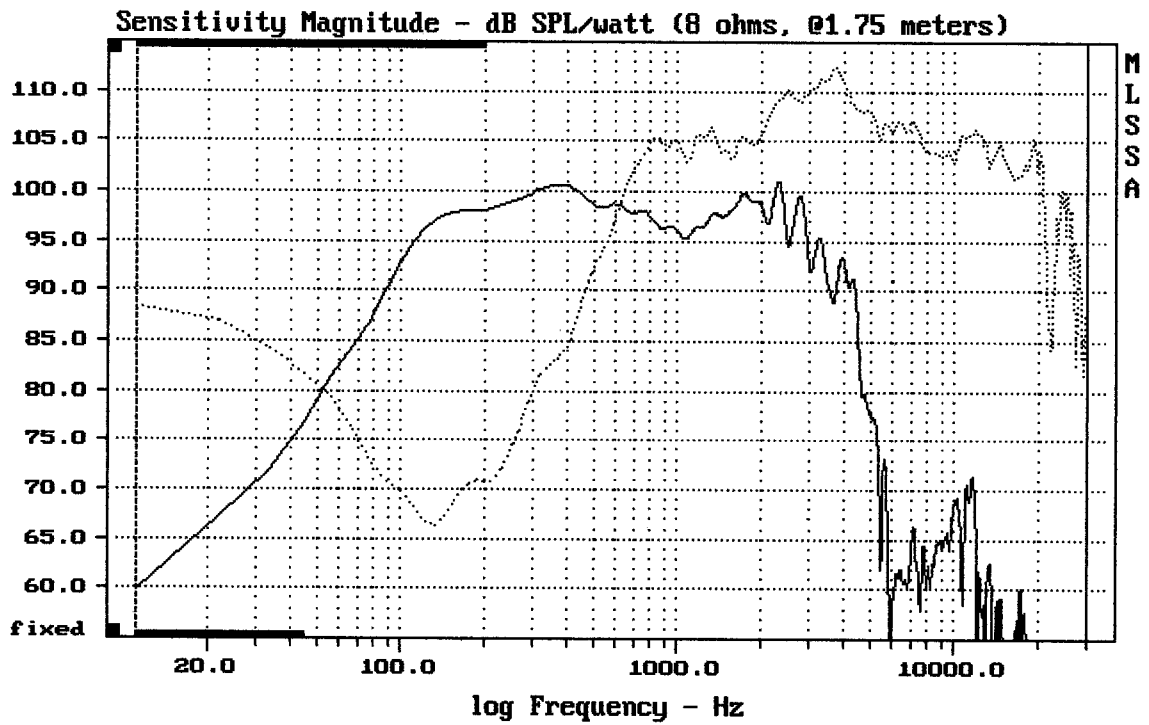

CURSOR:  $dy = 40.0318$   $x = 30007.1014$  (2704)

15NDL76 + DE500 + H100

MLSSA: Frequency Domain

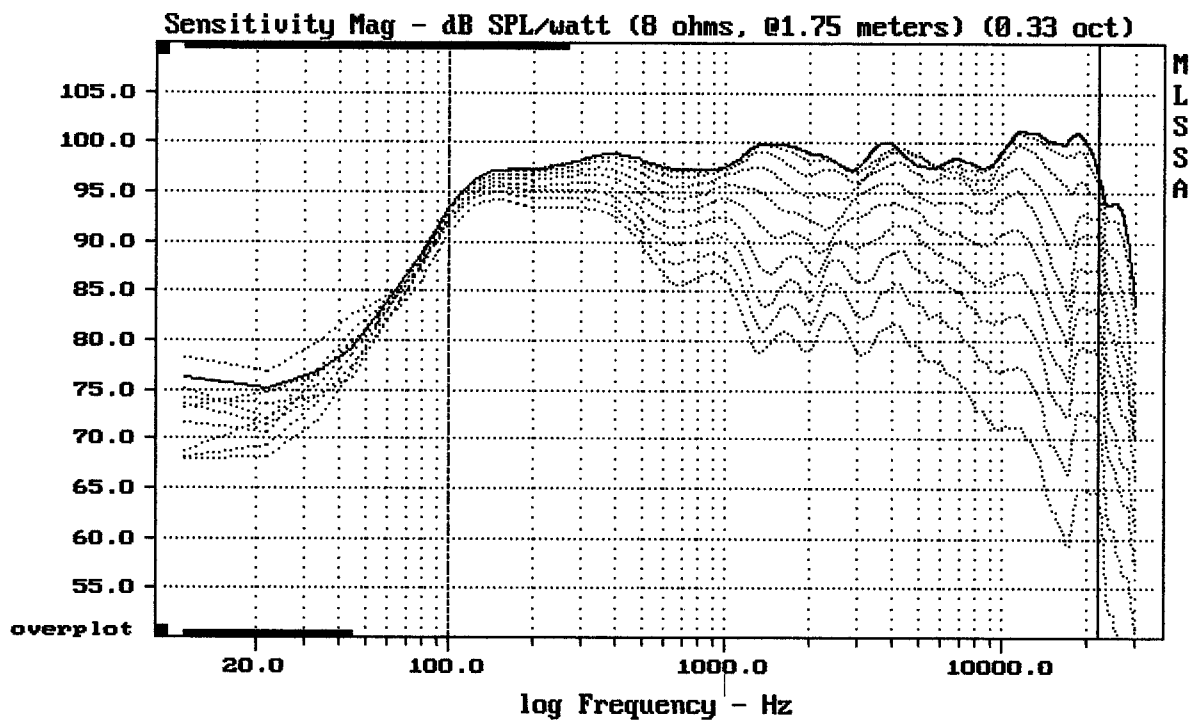

Overlay Compare: dev= +26/-13, std= 8.5, avg= -28

15NDL76 + DE500 + H100

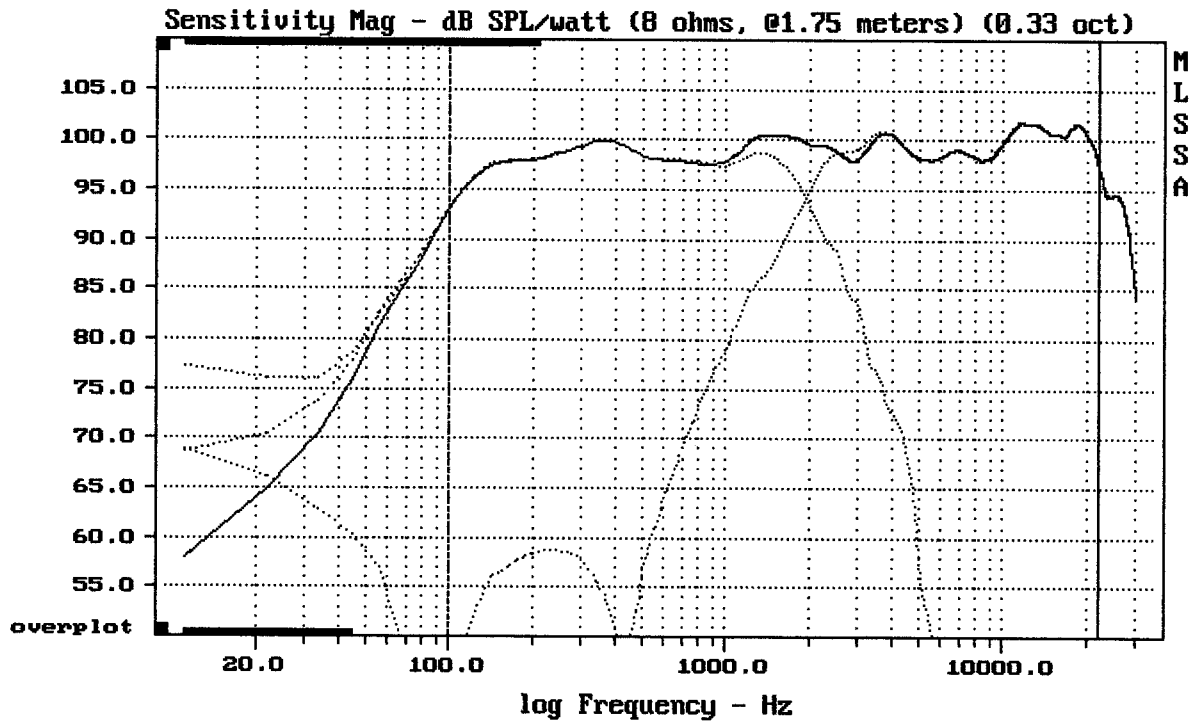

Level (100:22006 Hz) = 99.14 dB SPL/watt (8 ohms, @1.75 meters) (0.33 oct)

15NDL76 + DE500 + H100

MLSSA: Frequency Domain

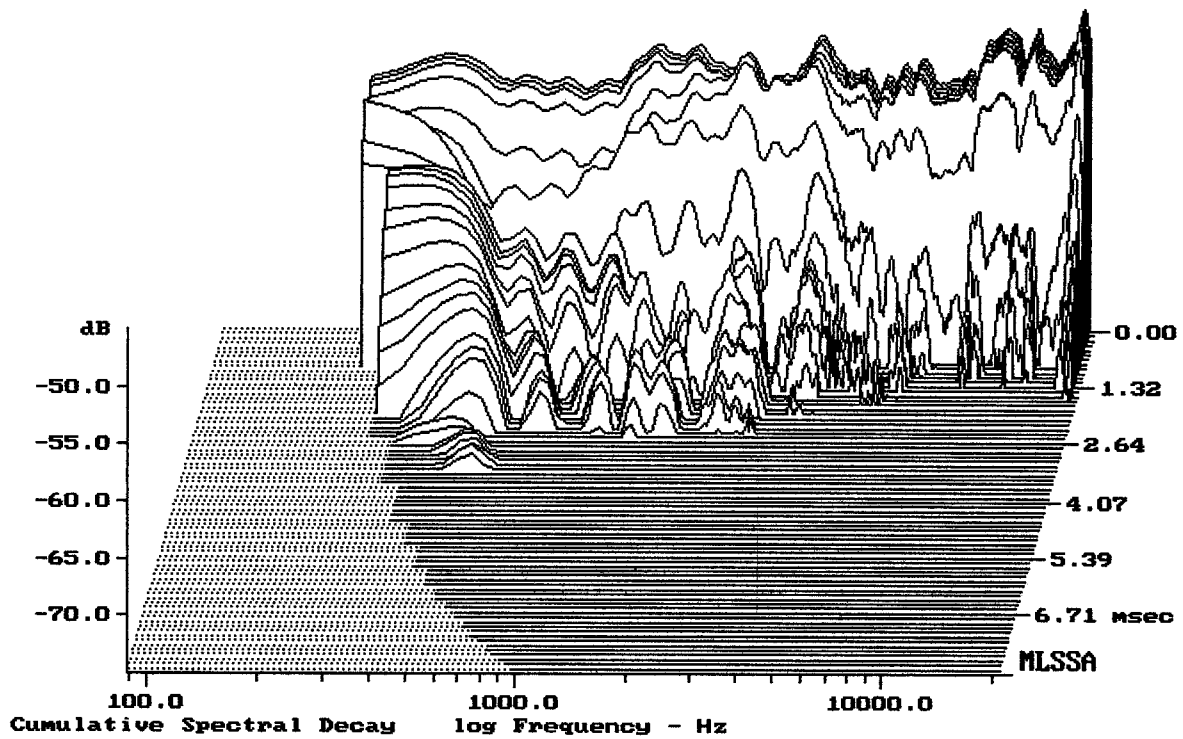

-73.75 dB, 2841 Hz (64), 2.420 msec (23)

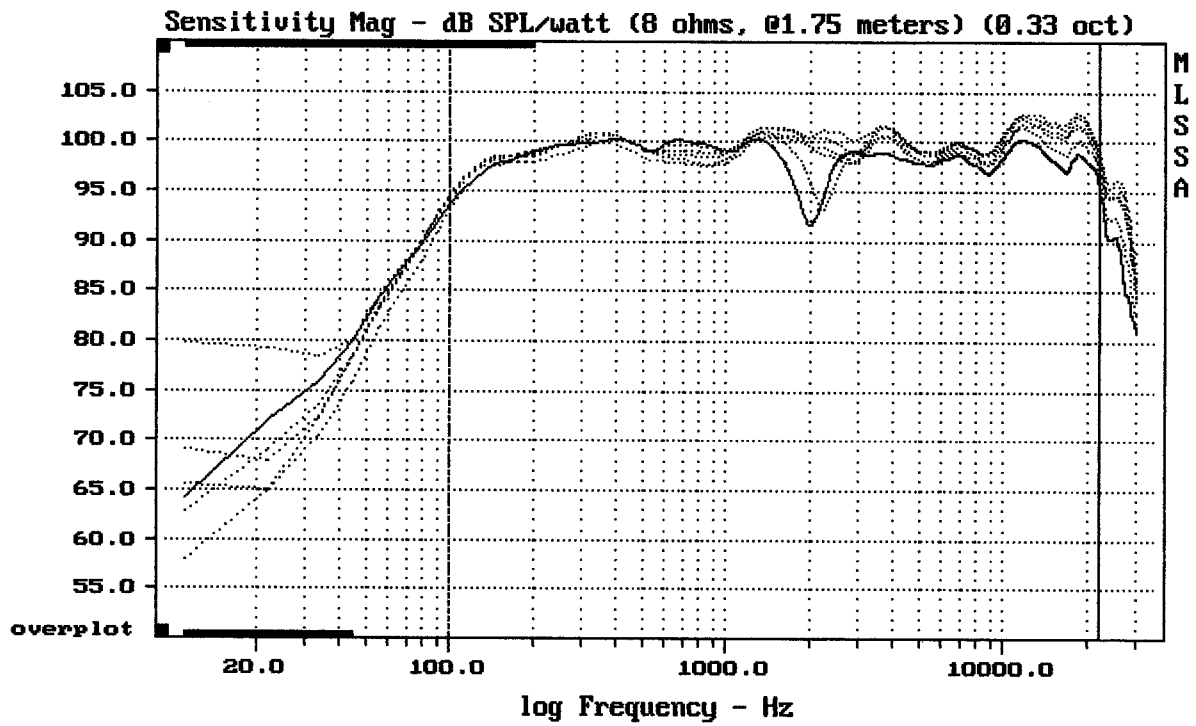

Overlay Compare: dev= +1.3/-1, std= 0.35, avg= 1.2

15NDL76 + DE500 + H100

MLSSA: Frequency Domain

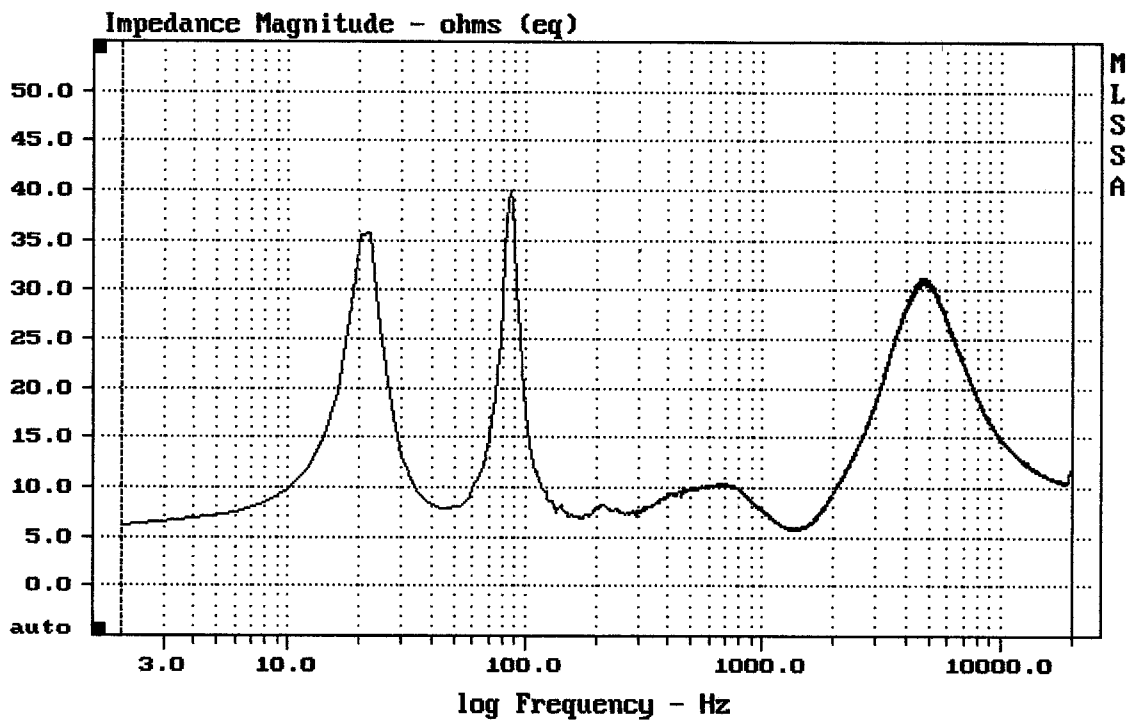

mean: 15.5, rms: 16.84, std: 6.593, max: 39.97, min: 5.675

15NDL76 + DE500 + H100