

Sestava B&C Speakers 15NDL76 + DE72 + ME90

Osazení:

- B&C Speakers 15NDL76 8/Ohm
<http://eshop.prodance.cz/DetailPage.asp?DPG=82860>
- B&C Speakers DE72 8/Ohm
<http://eshop.prodance.cz/DetailPage.asp?DPG=82321>
- B&C Speakers ME90
<http://eshop.prodance.cz/DetailPage.asp?DPG=80246>

Schéma výhybky:

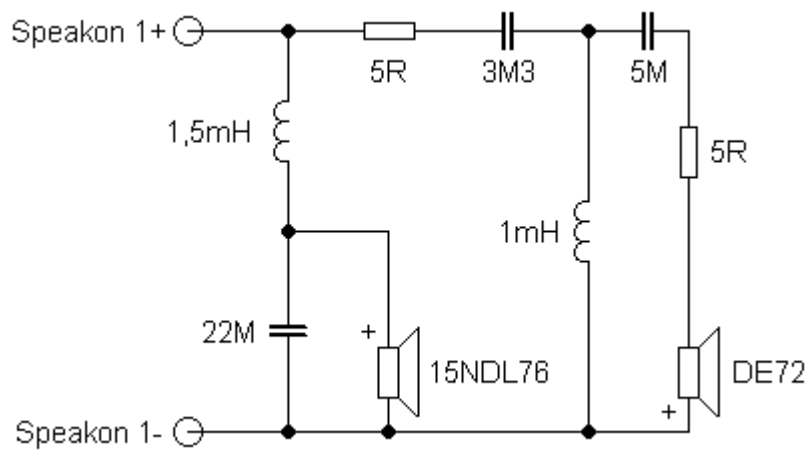

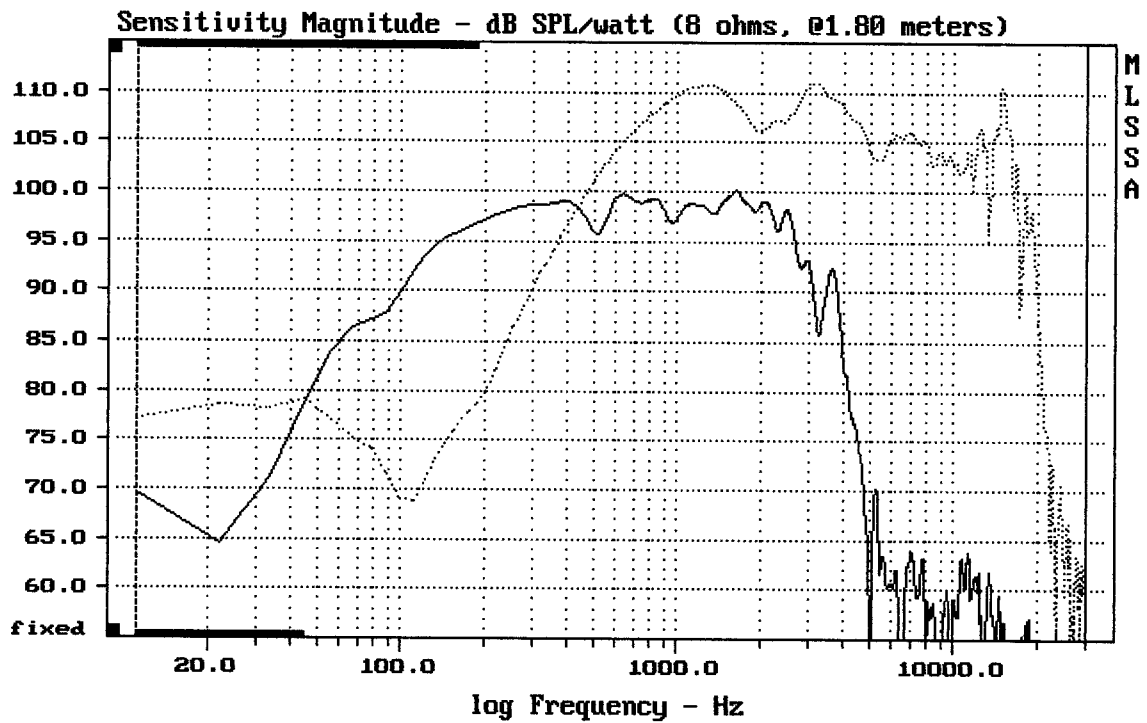

CURSOR: dy = 17.6888 x = 30007.1014 (2704)

15NDL76 + DE72 + ME90

MLSSA: Frequency Domain

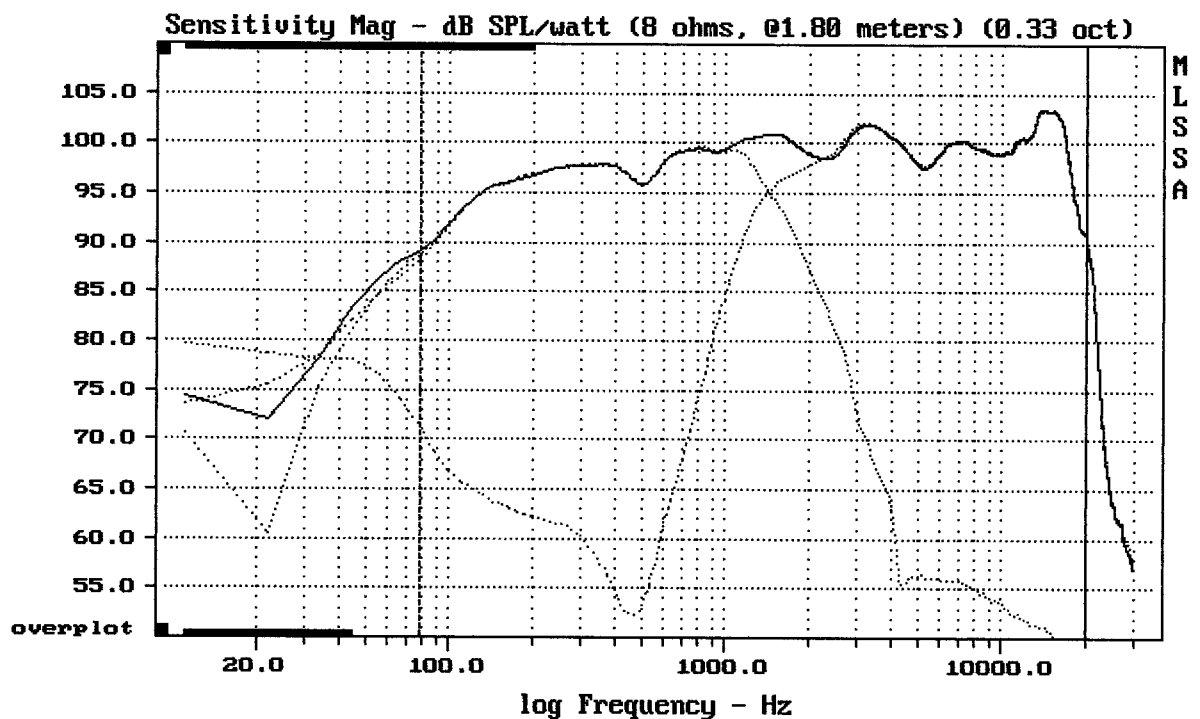

Level (78:19997 Hz) = 98.92 dB SPL/watt (8 ohms, @1.80 meters) (0.33 oct)

15NDL76 + DE72 + ME90

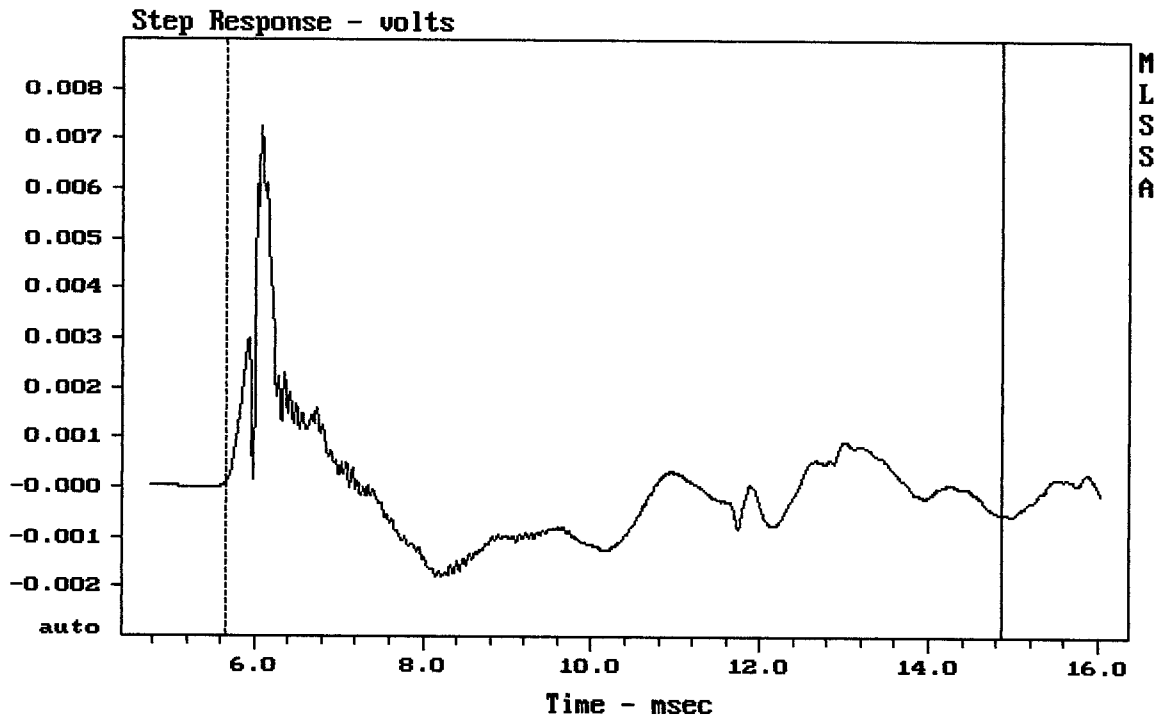

mean: $-4.231e-005$, rms: 0.001255, std: 0.001254, max: 0.007252, min: -0.001786

15NDL76 + DE72 + ME90

MLSSA: Time Domain

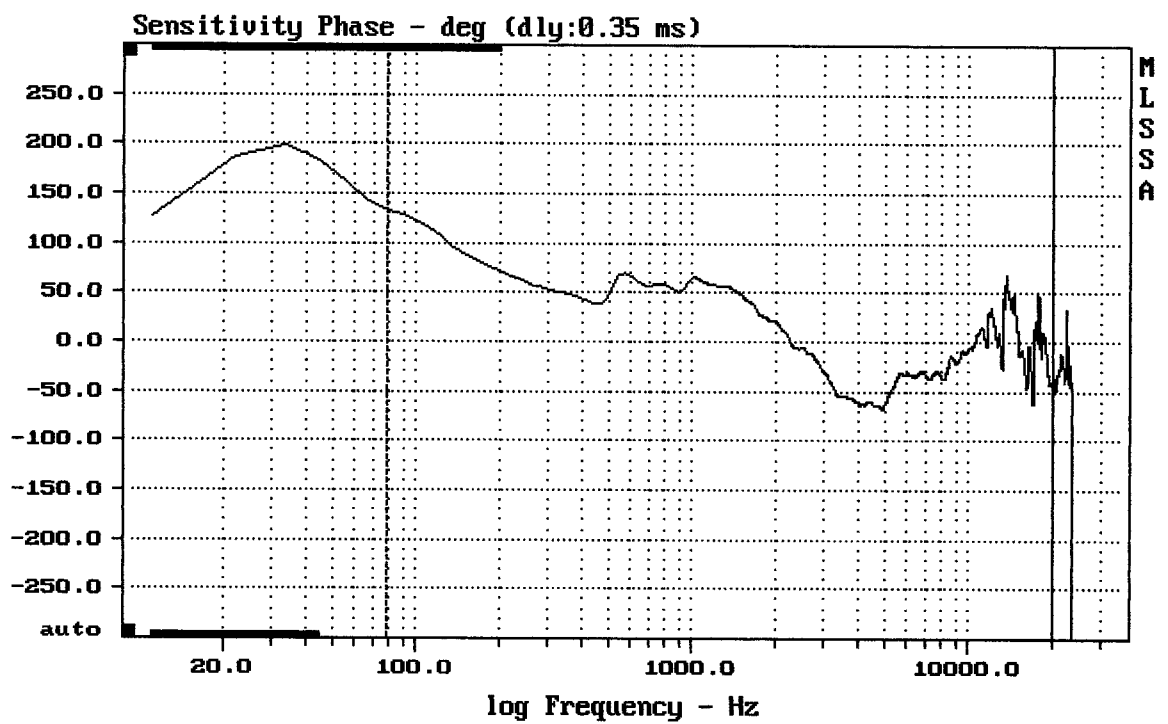

mean: -7.198, rms: 36, std: 35.27, max: 132.4, min: -67.53

15NDL76 + DE72 + ME90

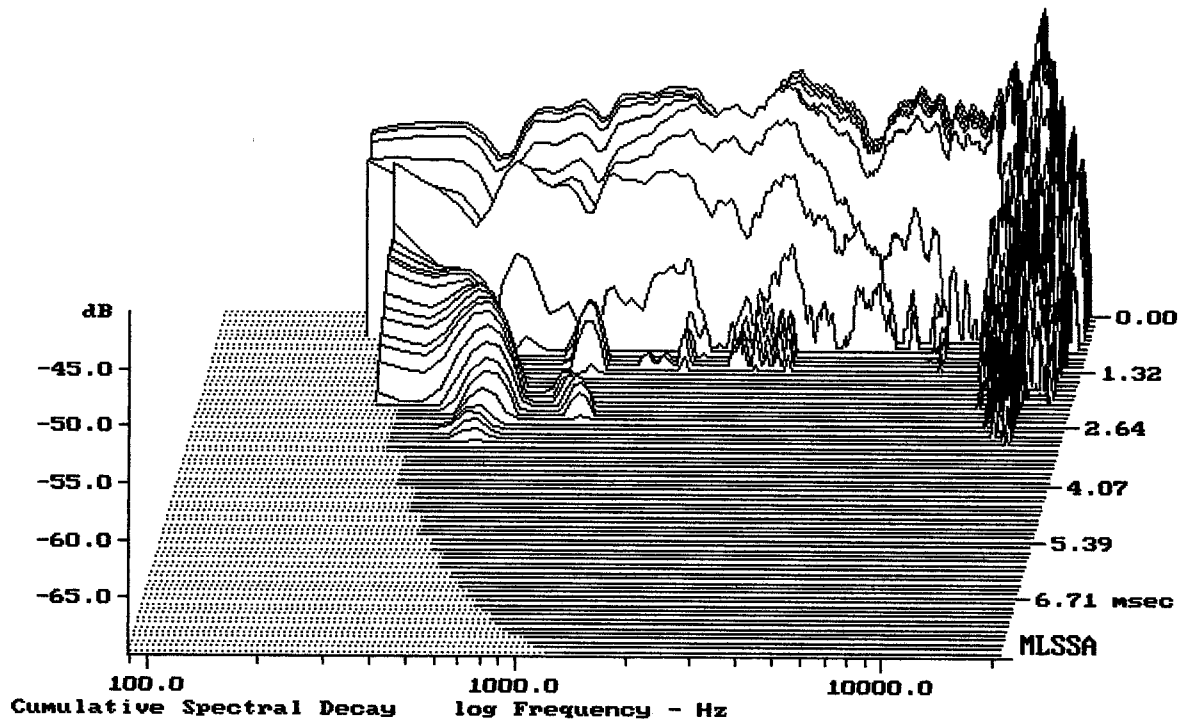

-67.79 dB, 2486 Hz (56), 1.210 msec (12)

DTTO

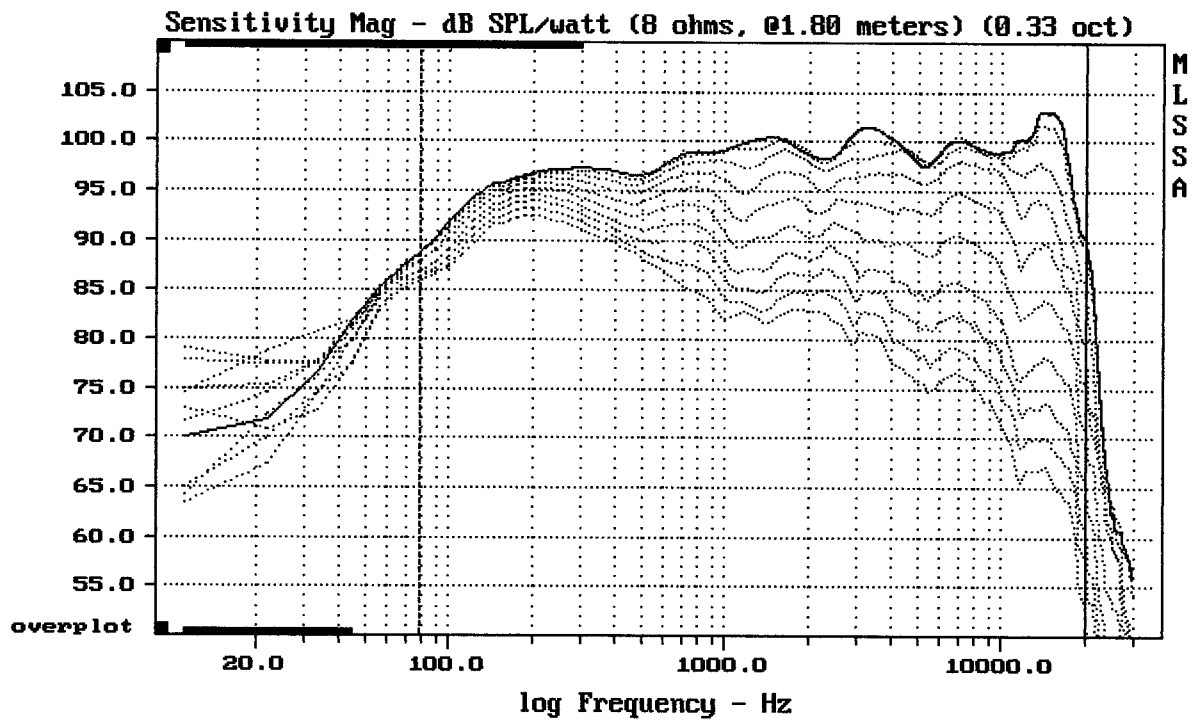

Overlay Compare: dev= +26/-9.8, std= 7.8, avg= -28

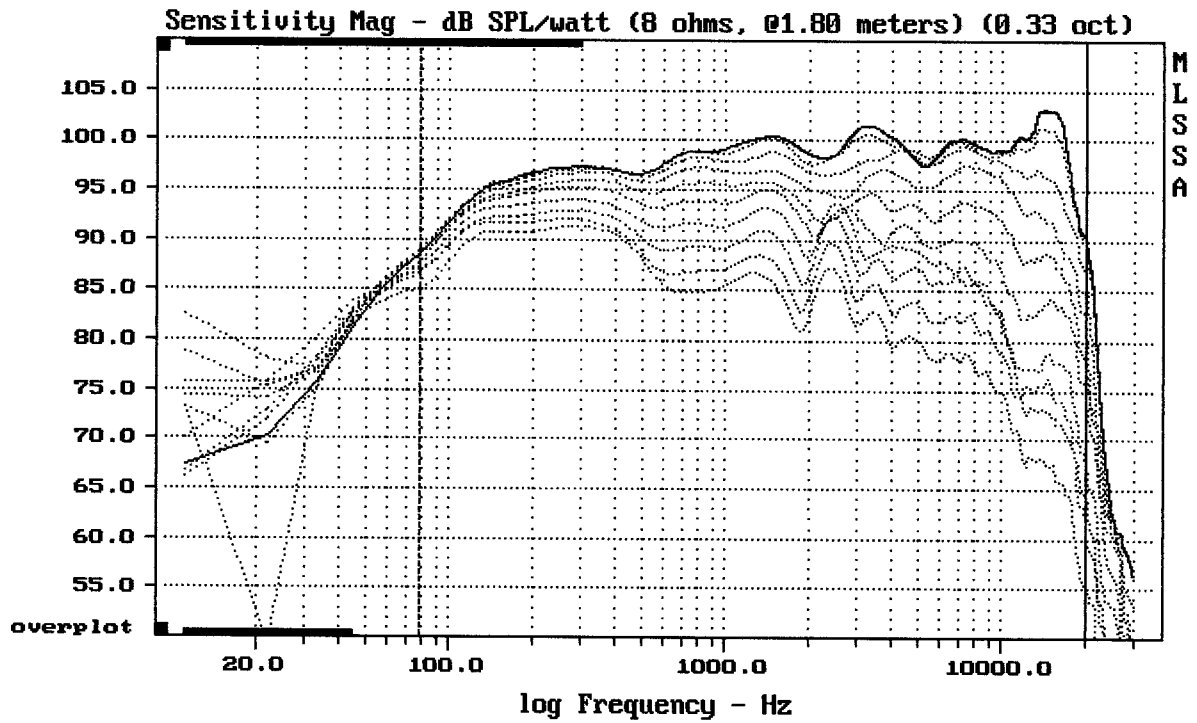

Overlay Compare: dev= +23/-11, std= 8.2, avg= -26

15NDL76 + DE72 + ME90

MLSSA: Frequency Domain

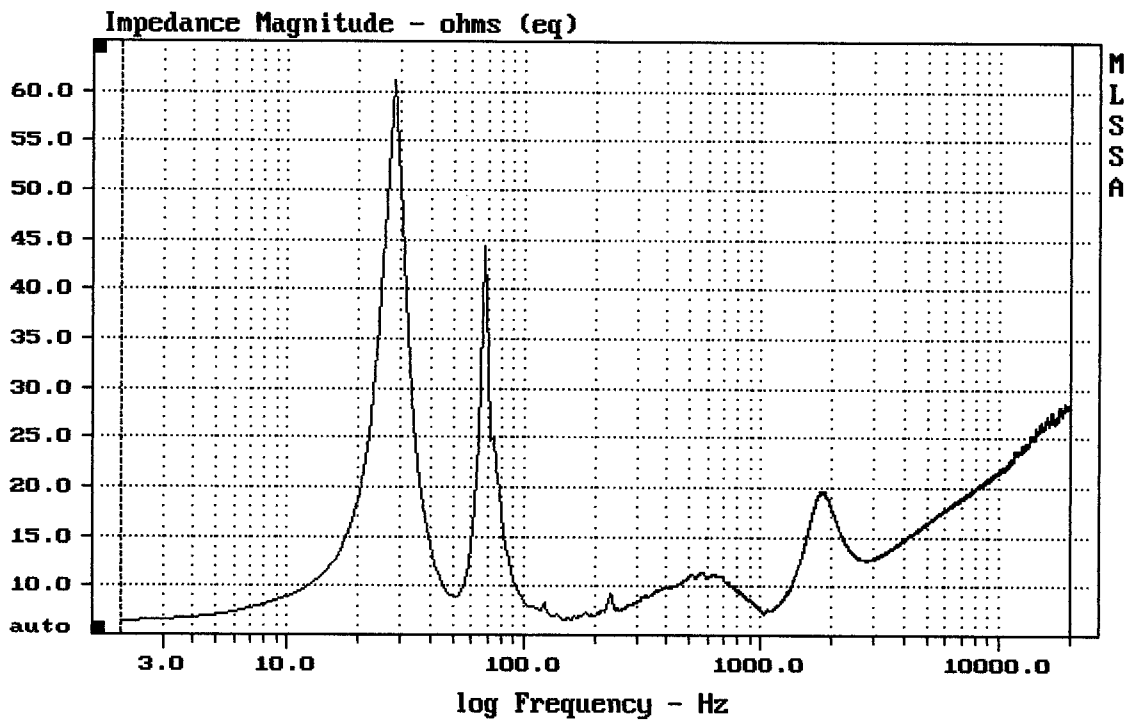

mean: 20.91, rms: 21.65, std: 5.585, max: 61.05, min: 6.306

15NDL76 + DE72 + ME90