

Sestava 2x B&C Speakers 10MD26 + RCF ND3030T3 + Megaton B8575

Osazení:

- 2x B&C Speakers 10MD26 8/Ohm
<http://eshop.prodance.cz/DetailPage.asp?DPG=82623>
- RCF ND3030T3 8/Ohm
<http://eshop.prodance.cz/DetailPage.asp?DPG=79637>
- Megaton B8575
<http://eshop.prodance.cz/DetailPage.asp?DPG=84261>

Schéma výhybky:

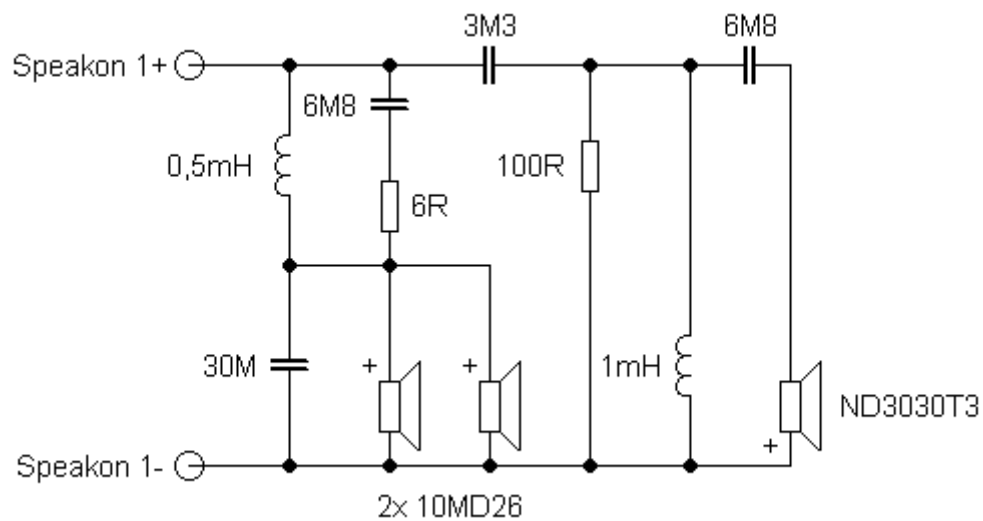

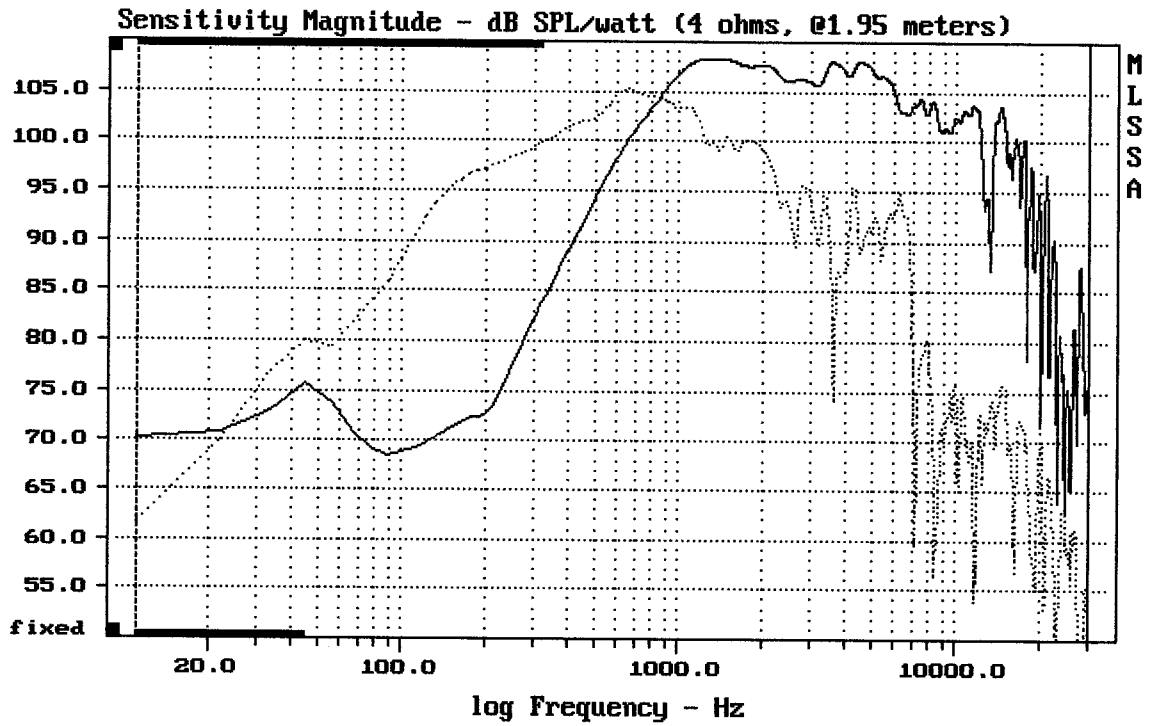

2x 10MD26 + ND3030T3 + B8575

MLSSA: Frequency Domain

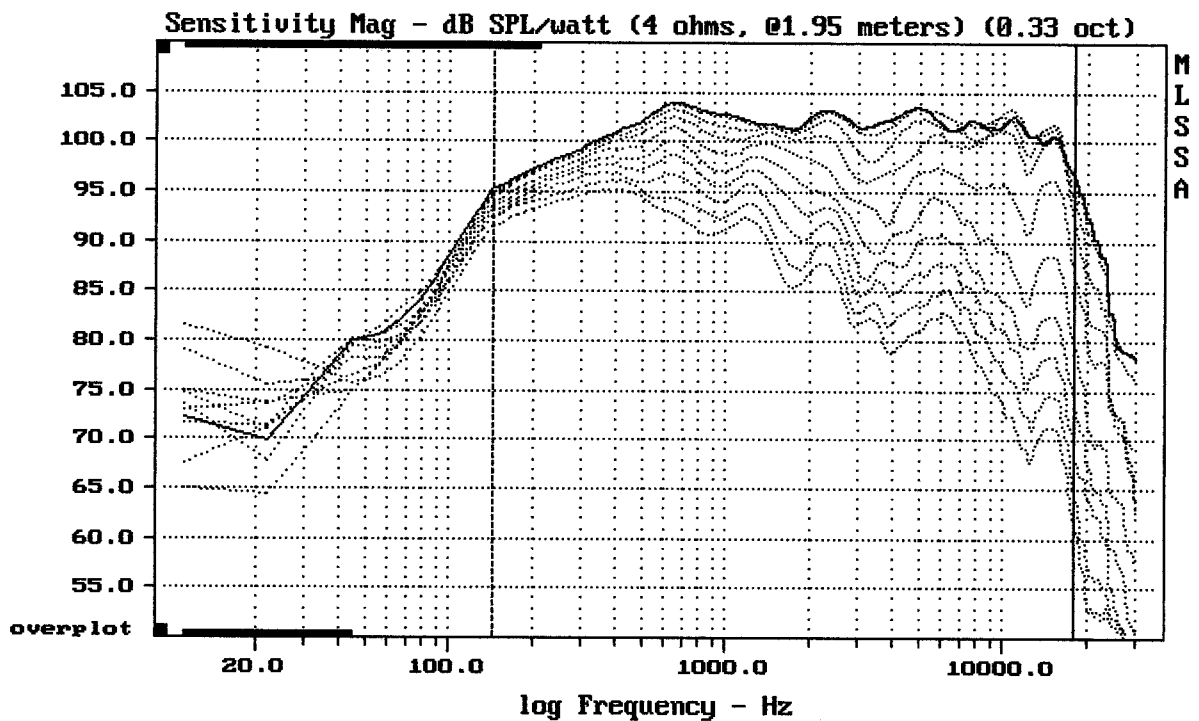

2x 10MD26 + ND3030T3 + B8575

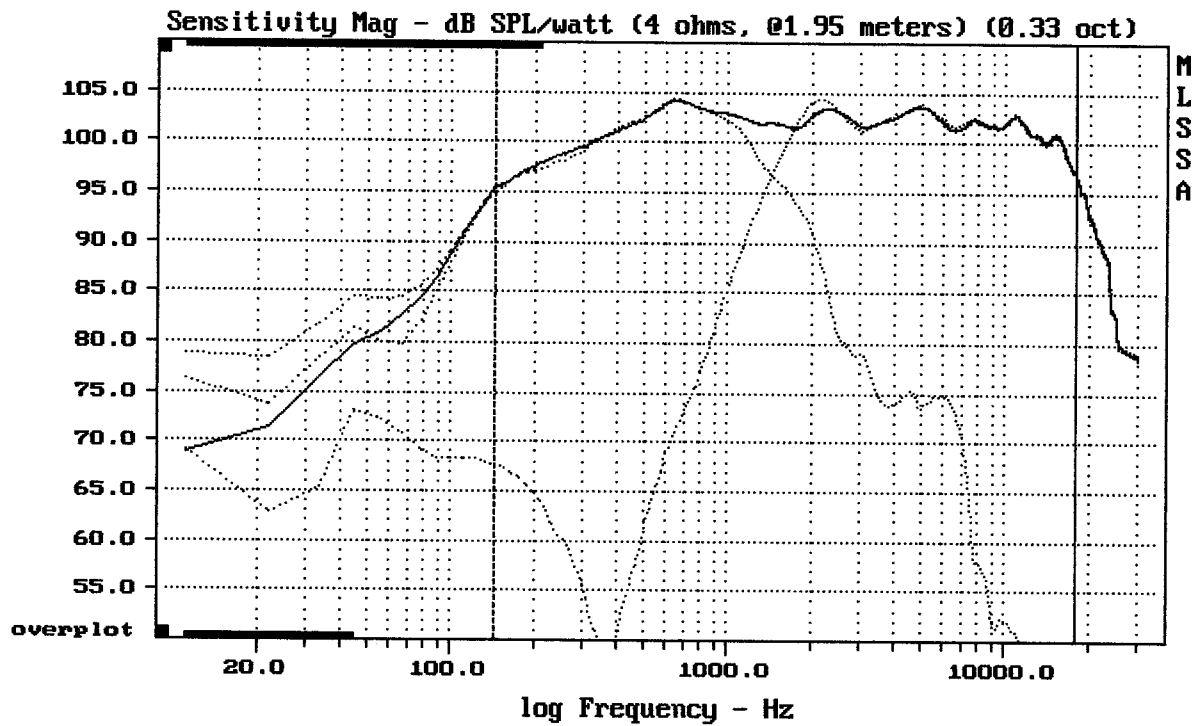

Level (144:18011 Hz) = 101.74 dB SPL/watt (4 ohms, @1.95 meters) (0.33 oct)

2x 10MD26 + ND3030T3 + B8575

MLSSA: Frequency Domain

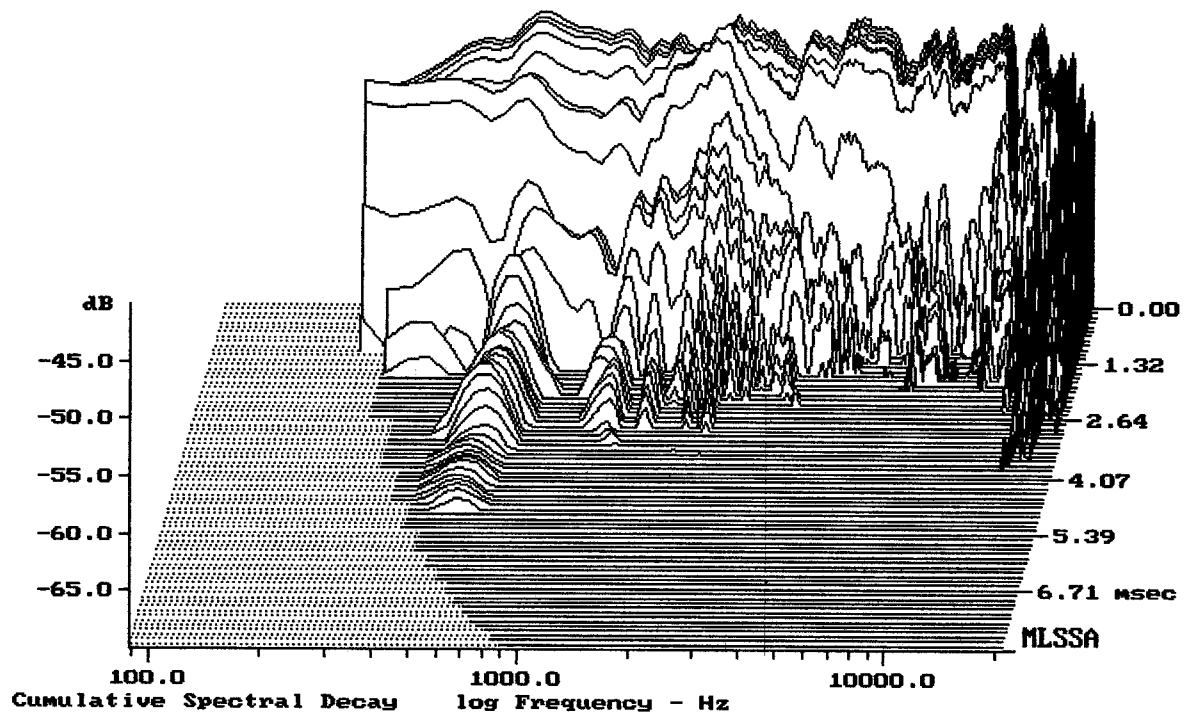

-70.00 dB, 2042 Hz (46), 2.530 msec (24)

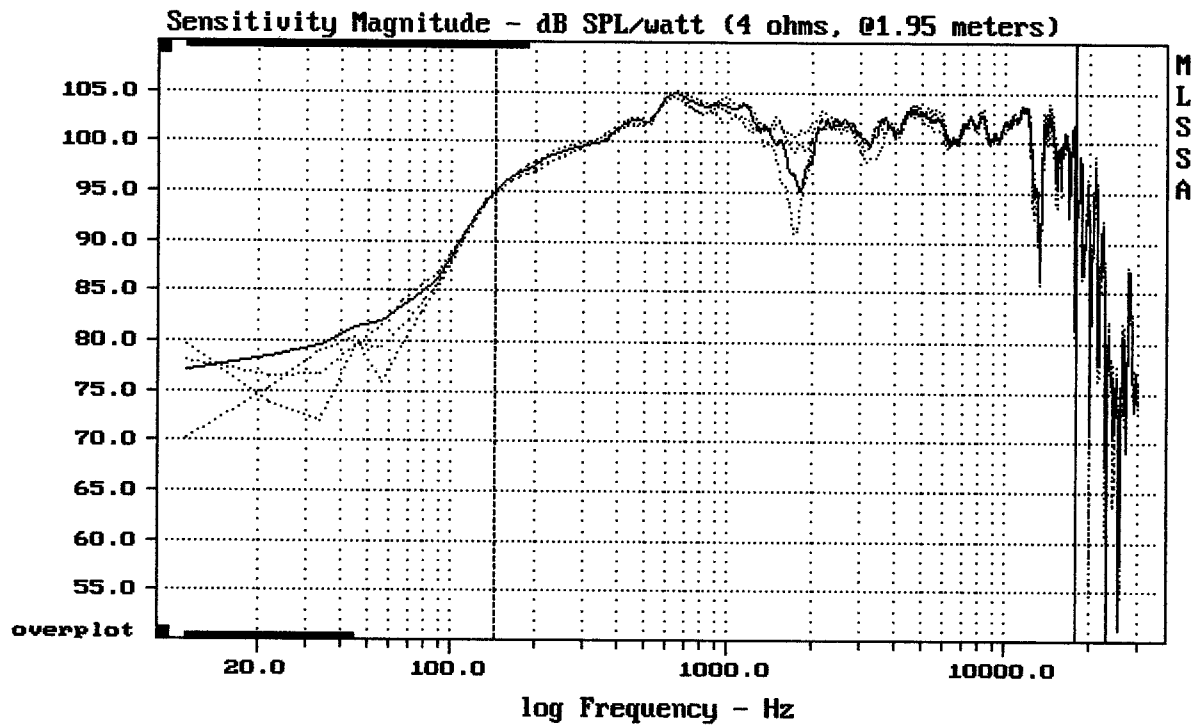

CURSOR: y = 91.6157 x = 18010.9192 (1623)

2x 10MD26 + ND3030T3 + B8575

MLSSA: Frequency Domain

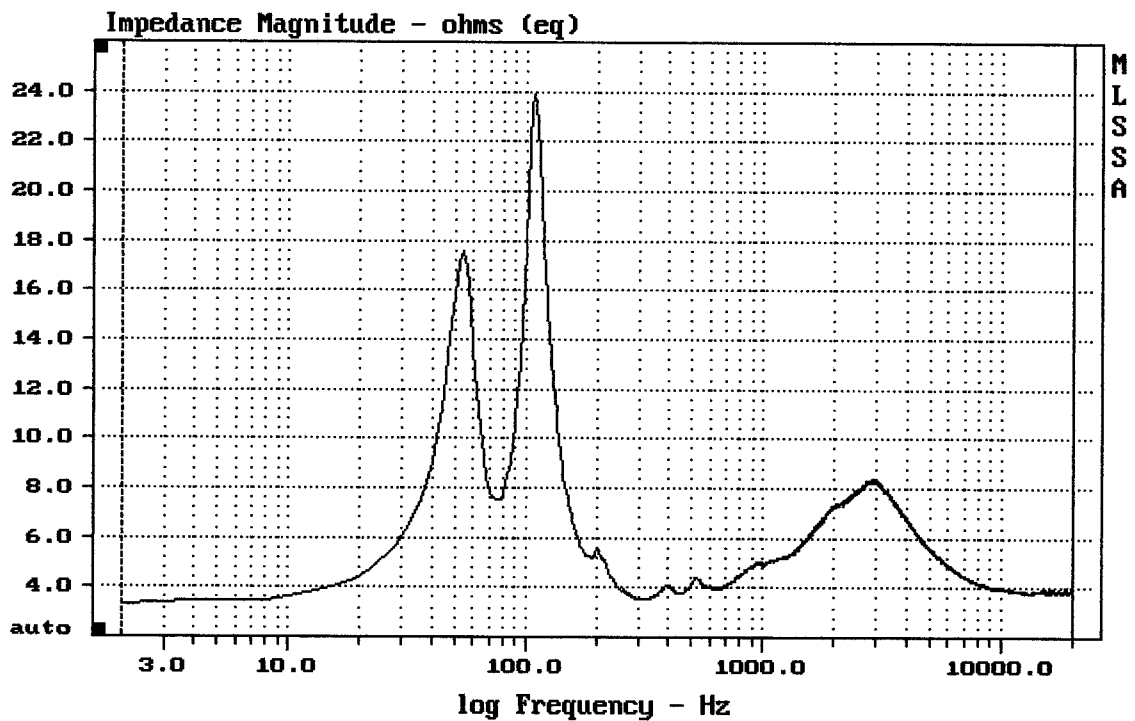

mean: 4.694, rms: 4.912, std: 1.447, max: 23.91, min: 3.361

2x 10MD26 + ND3030T3 + B8575