

Sestava Eminence Beta-8 + Selenium ST322

Osazení:

- Eminence Beta-8 8/Ohm

<http://eshop.prodance.cz/DetailPage.asp?DPG=84341>

- Selenium ST322 8/Ohm

<http://eshop.prodance.cz/DetailPage.asp?DPG=77680>

Schémata výhybek: *pozn.: uspořádání MTM (D'Appolito)

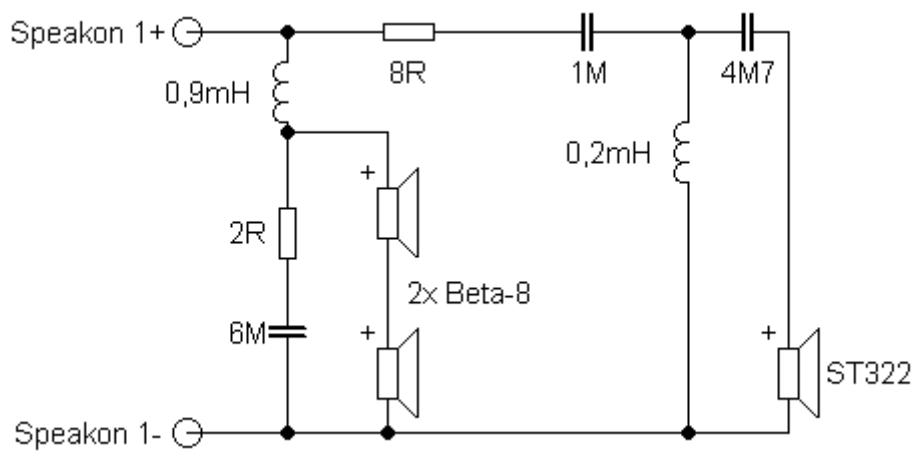

varianta I.

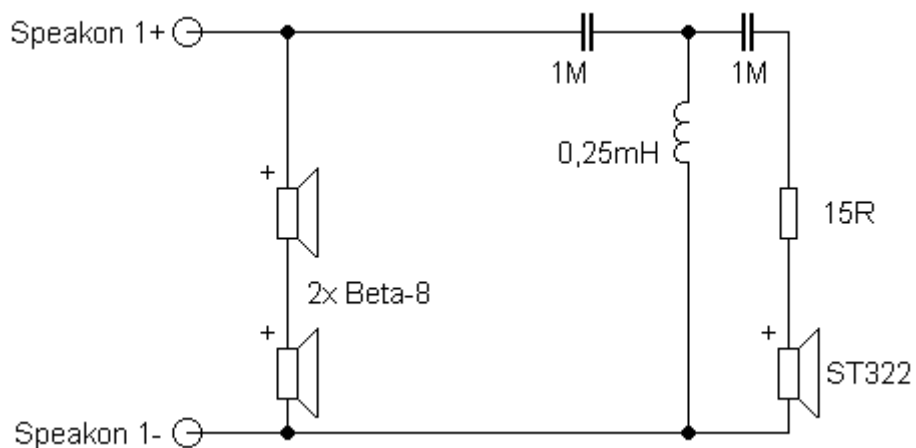

varianta II.

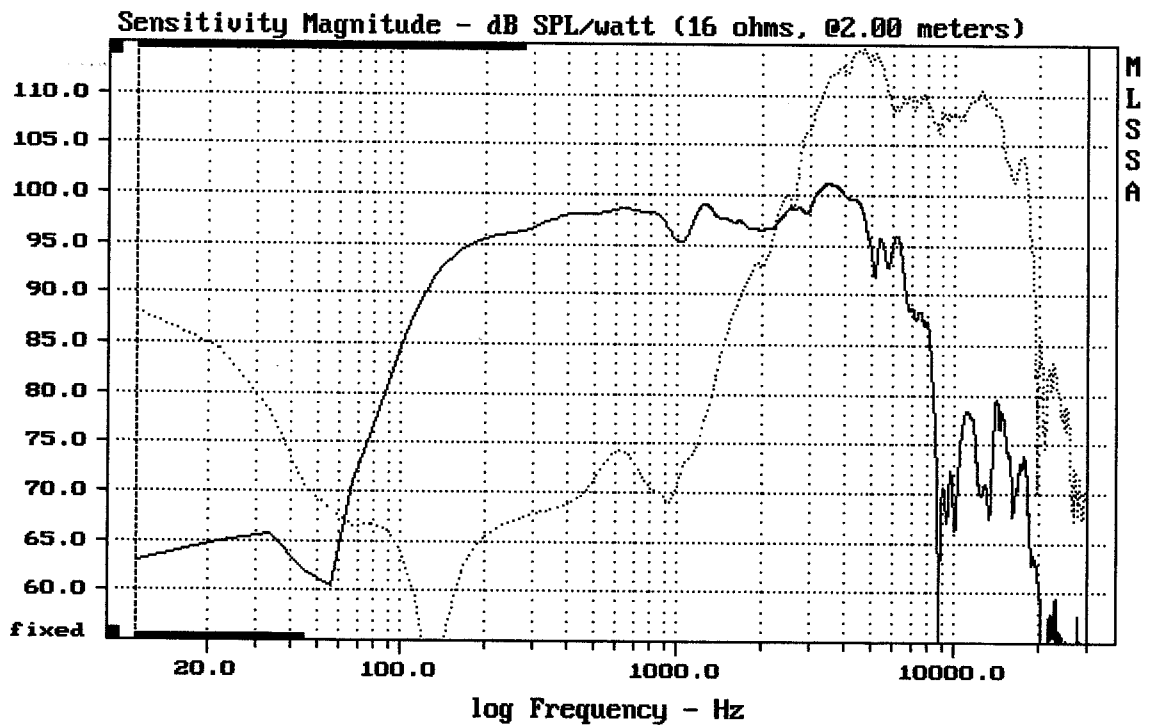

CURSOR: dy = 32.535 x = 30007.1014 (2704)

2x BETA 8 + ST322

MLSSA: Frequency Domain

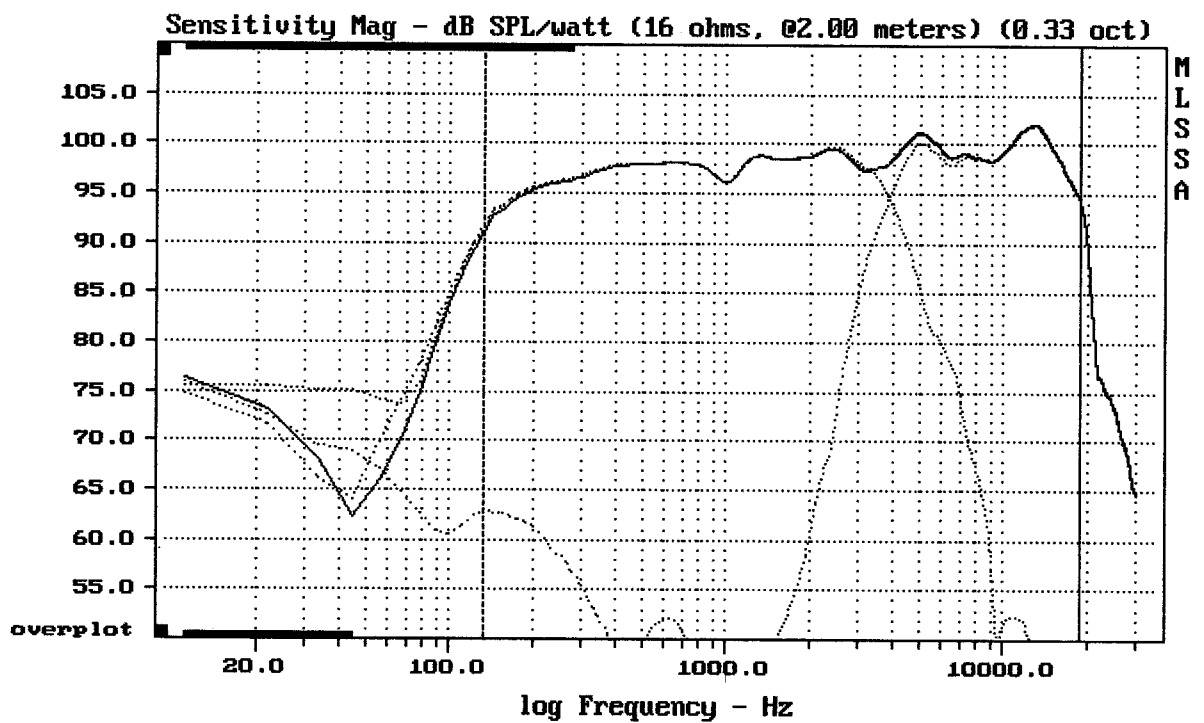

Level (133:19010 Hz) = 98.28 dB SPL/watt (16 ohms, @2.00 meters) (0.33 oct)

2x BETA 8 + ST322

Varianta I.

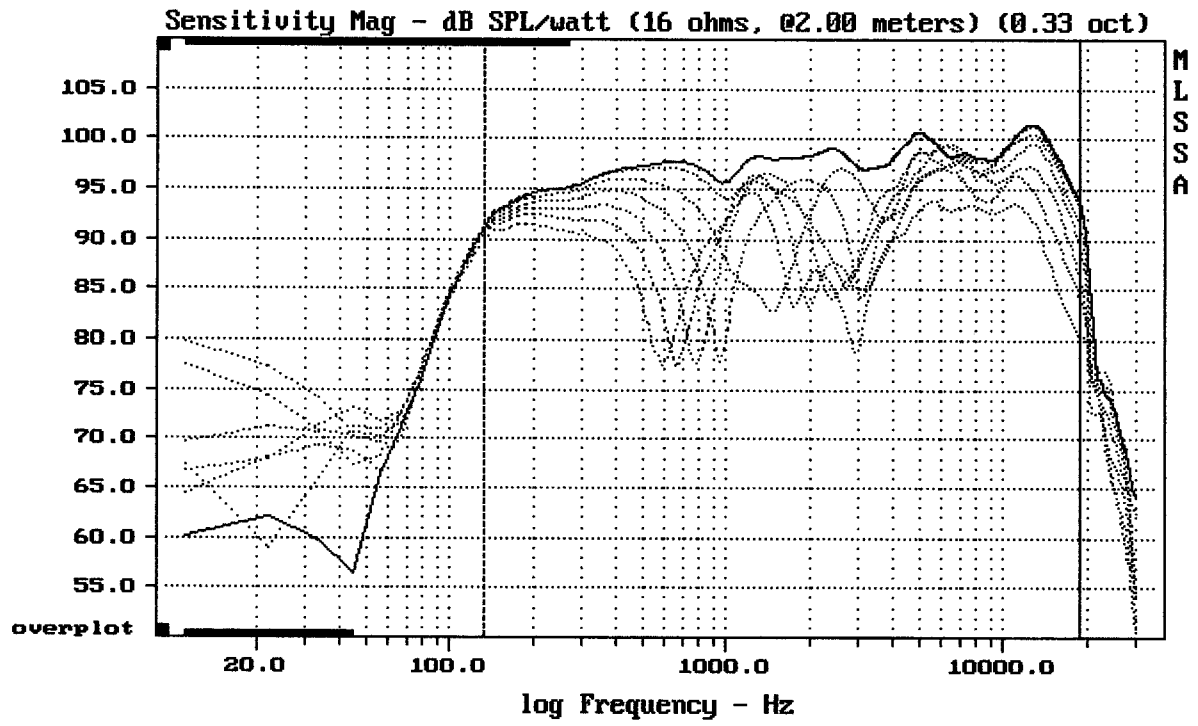

Overlay Compare: dev= +8/-11, std= 3.7, avg= -9.4

2x BETA 8 + ST322

MLSSA: Frequency Domain

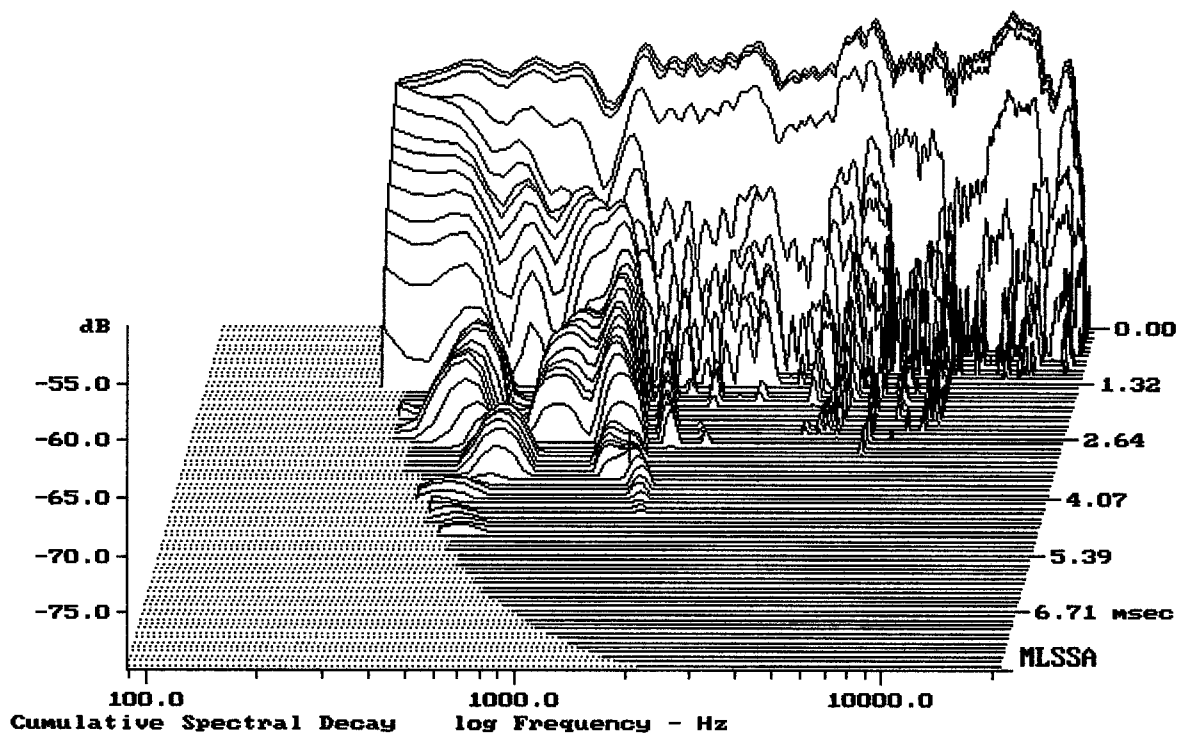

-77.62 dB, 1465 Hz (33), 3.520 msec (33)

Varianta I.

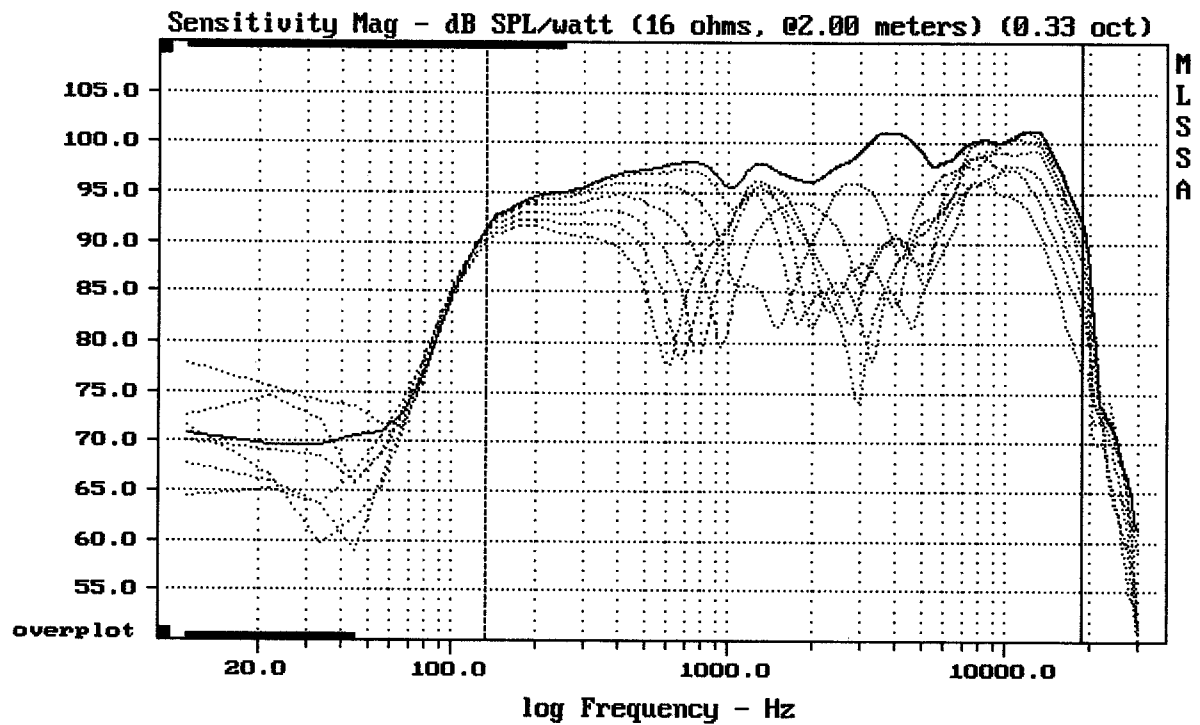

Overlay Compare: dev= +9.2/-14, std= 4.8, avg= -11

2x BETA 8 + ST322

MLSSA: Frequency Domain

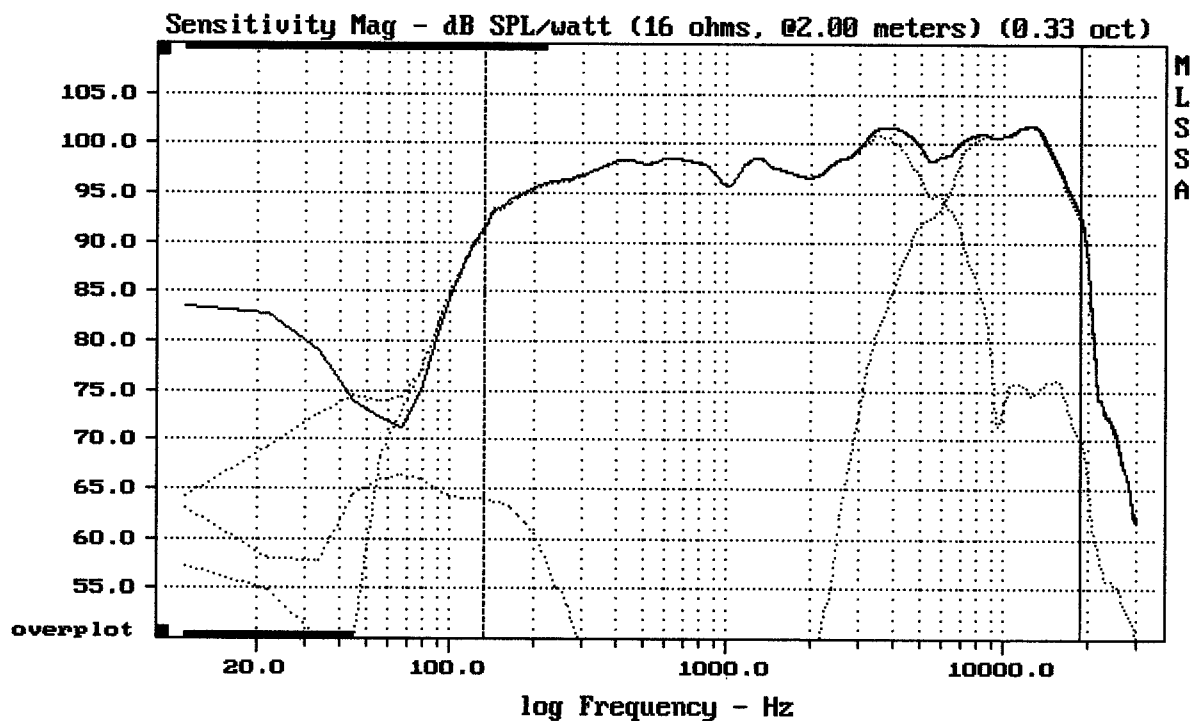

Level (133:19010 Hz) = 98.58 dB SPL/watt (16 ohms, @2.00 meters) (0.33 oct)

2x BETA 8 + ST322

Varianta II.