

Sestava Eminence Beta-8 + Selenium DT150

Osazení:

- Eminence Beta-8 8/ohm

<http://eshop.prodance.cz/DetailPage.asp?DPG=84341>

- Selenium DT150 8/ohm

<http://eshop.prodance.cz/DetailPage.asp?DPG=82055>

Schéma výhybky:

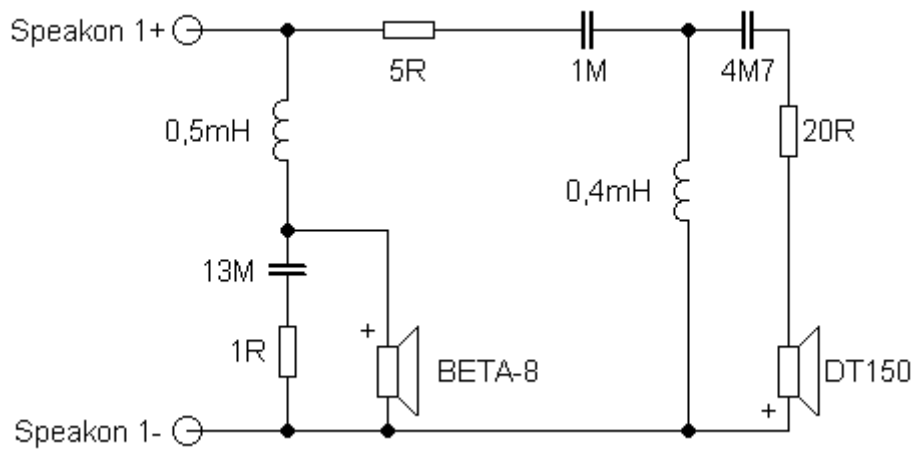

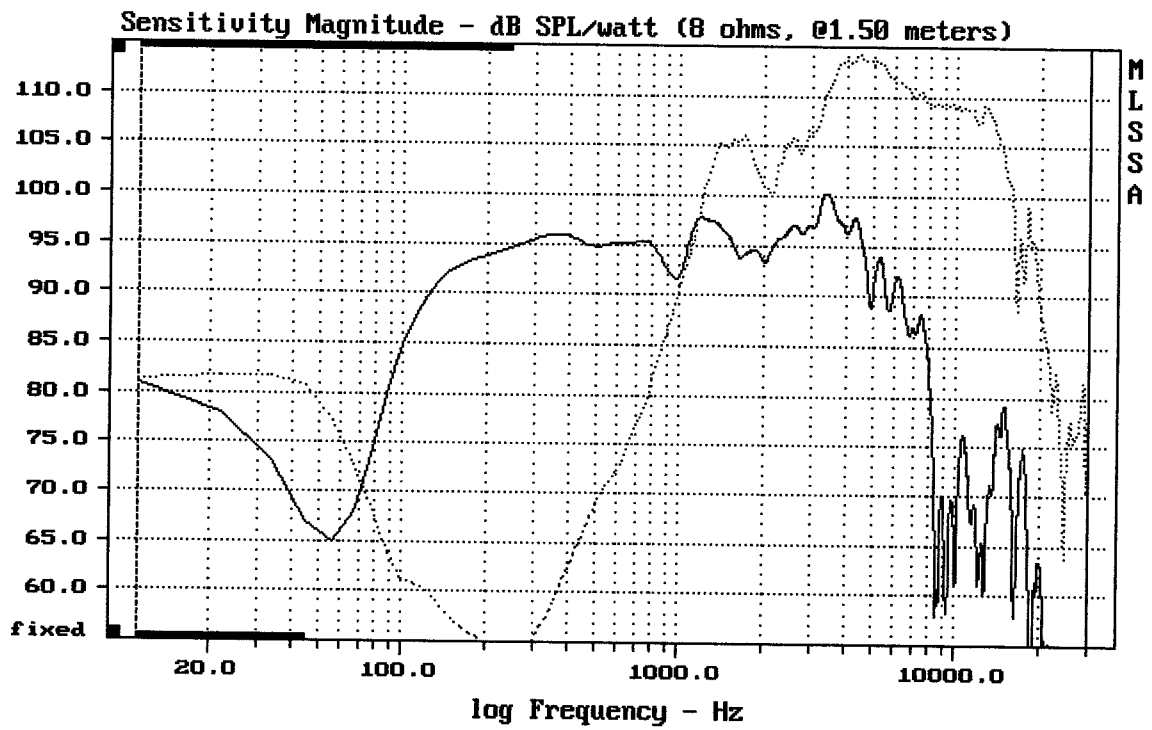

CURSOR: dy = 34.2447 x = 30007.1014 (2704)

BETA 8 + DT150

MLSSA: Frequency Domain

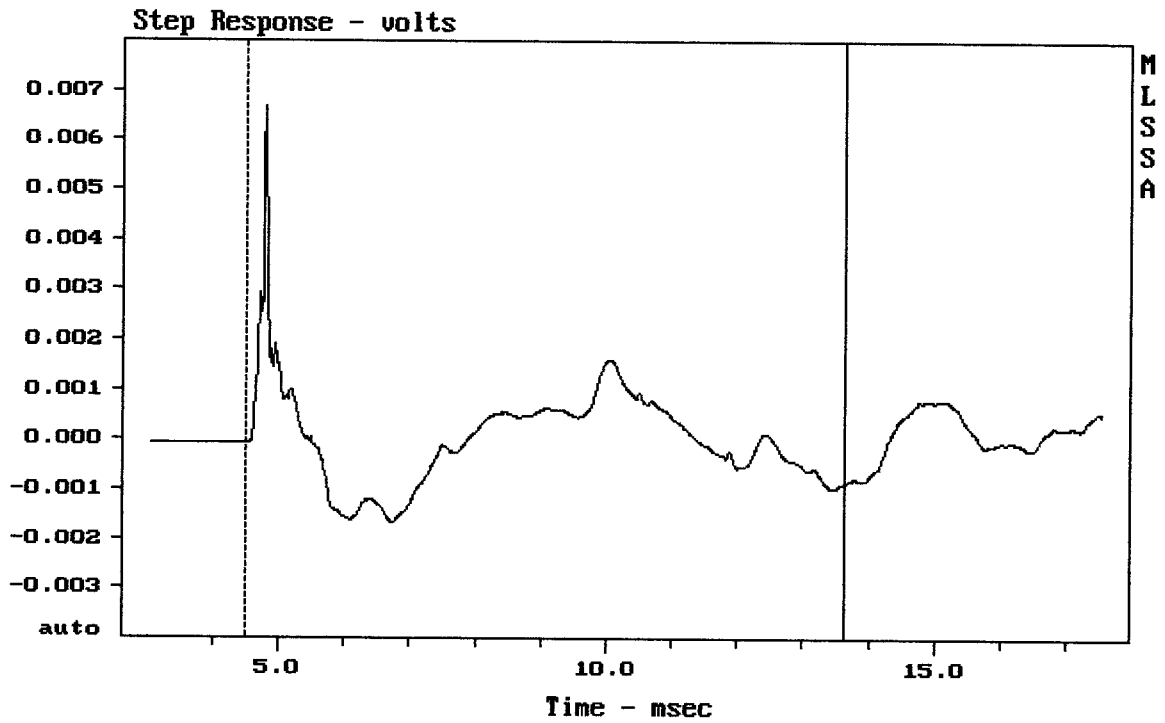

mean: 2.823e-005, rms: 0.0009861, std: 0.0009857, max: 0.006674, min: -0.001676

BETA 8 + DT150

I.

MLSSA: Time Domain

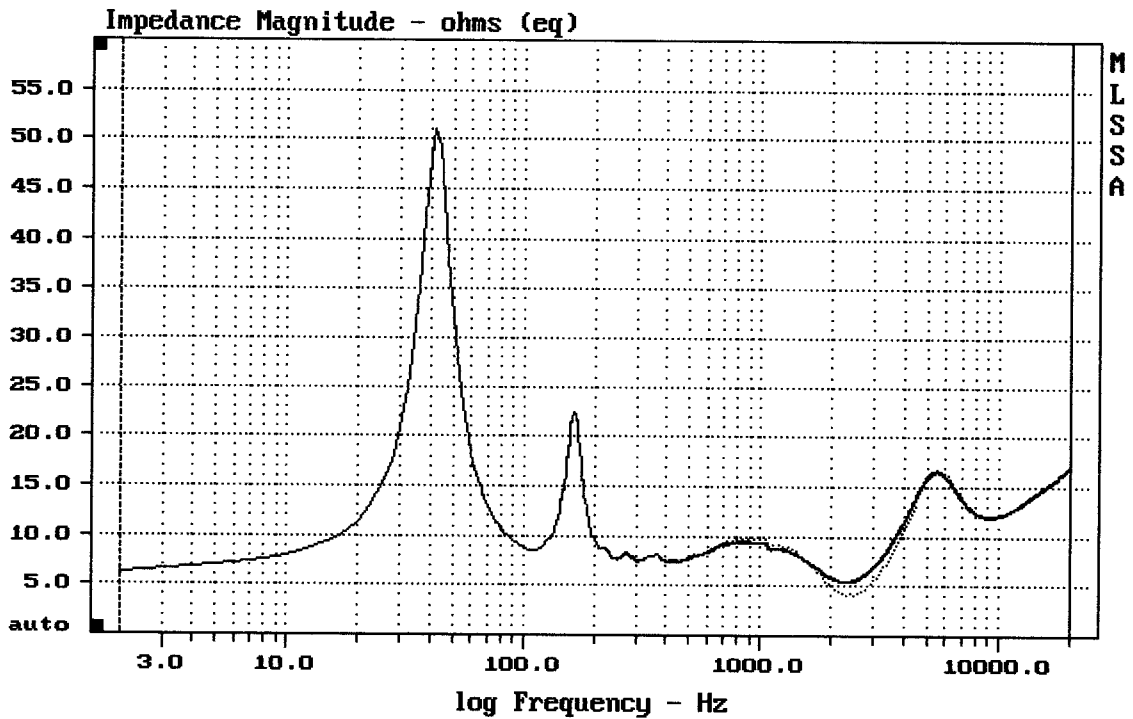

mean: 12.91, rms: 13.35, std: 3.391, max: 51.03, min: 4.103

BETA 8 + DT150

B72 1Ω / 8 1Ω

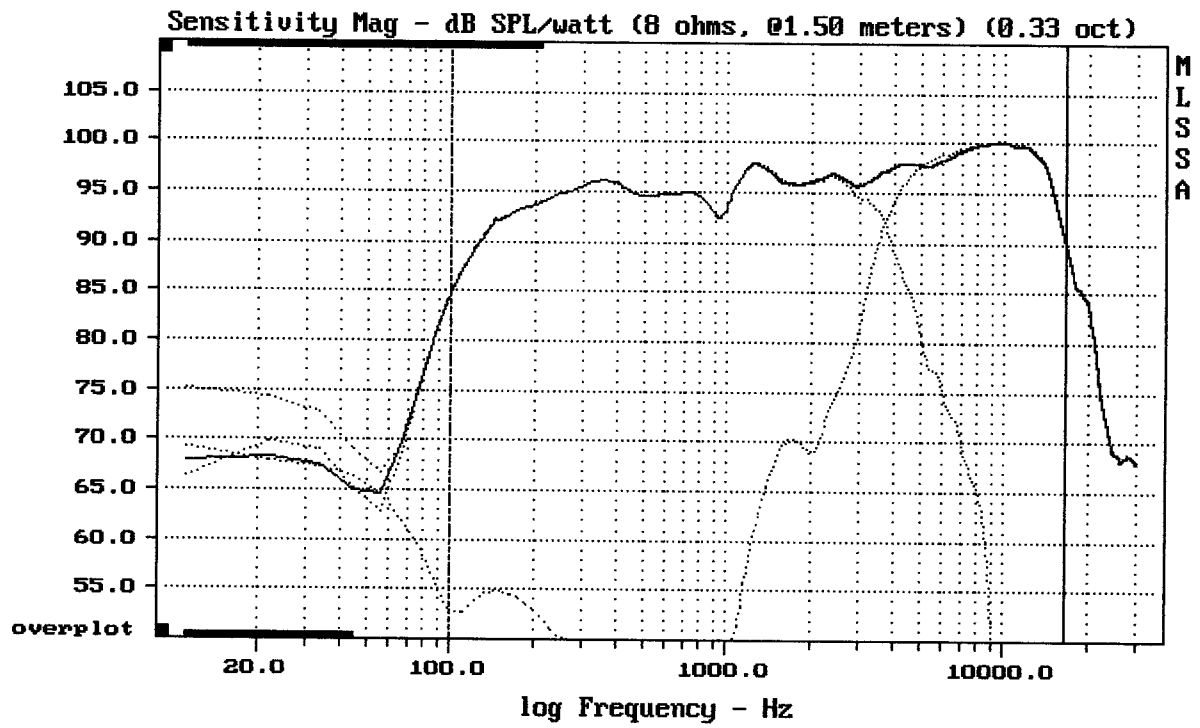

Level (100:16502 Hz) = 96.42 dB SPL/watt (8 ohms, @1.50 meters) (0.33 oct)

BETA 8 + DT150

MLSSA: Frequency Domain

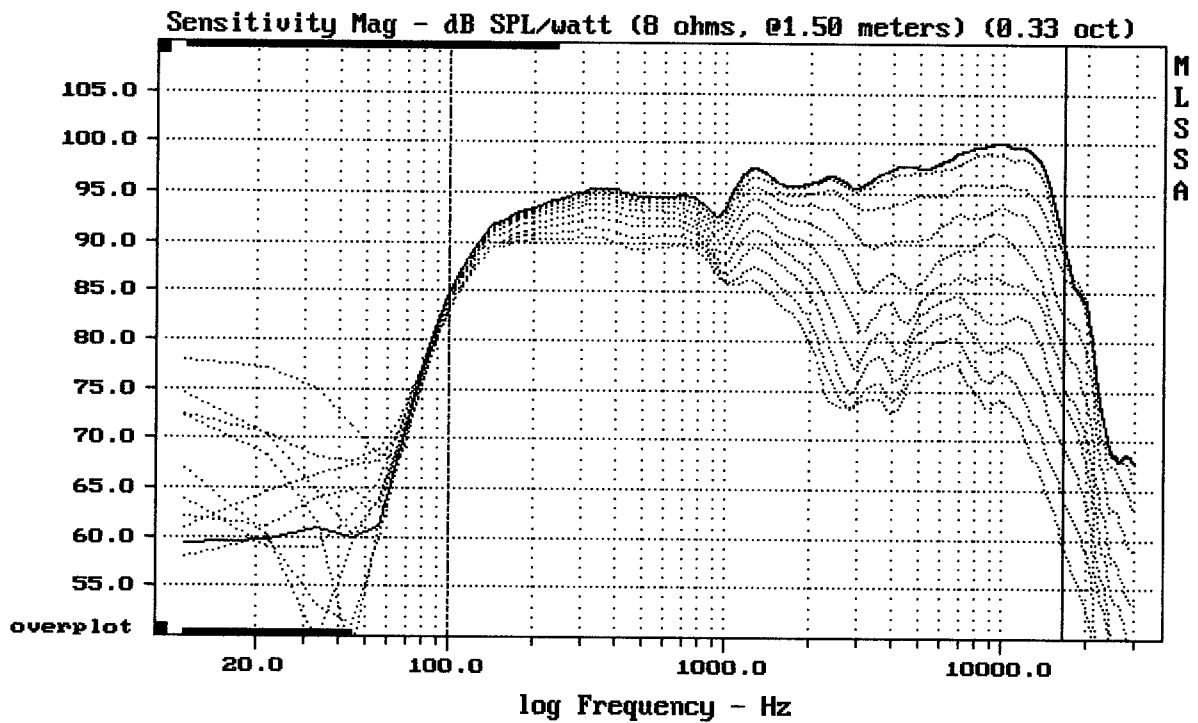

Overlay Compare: dev= +22/-7.9, std= 6.8, avg= -24

BETA 8 + DT150

II. FIKAL

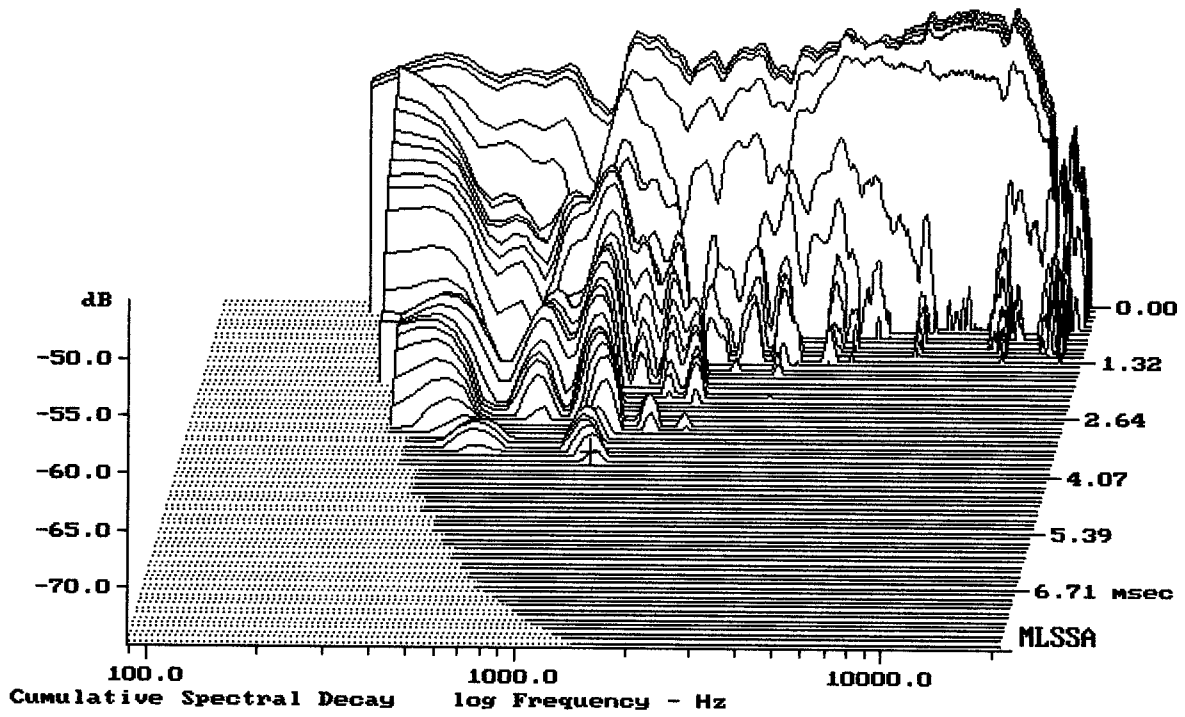

-74.15 dB, 1154 Hz (26), 3.740 msec (35)

DT10

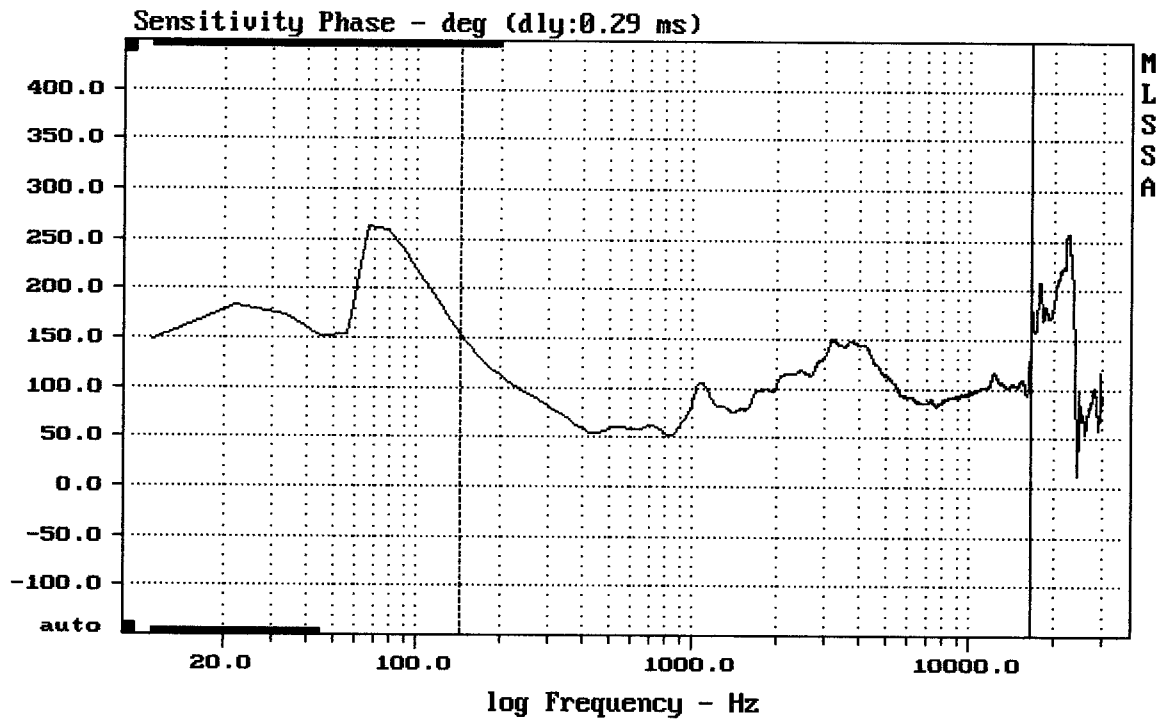

mean: 102.6, rms: 104.2, std: 18.34, max: 153.7, min: 52.18

BETA 8 + DT150