

## Sestava Ciare COD + Fane CD125 + Selenium HM17-25

### Osazení:

- Ciare COD 8/Ohm

<http://eshop.prodance.cz/DetailPage.asp?DPG=90805>

- Fane CD125 8/Ohm

<http://eshop.prodance.cz/DetailPage.asp?DPG=90660>

- Selenium HM17-25

<http://eshop.prodance.cz/DetailPage.asp?DPG=89344>

### Schéma výhybky:

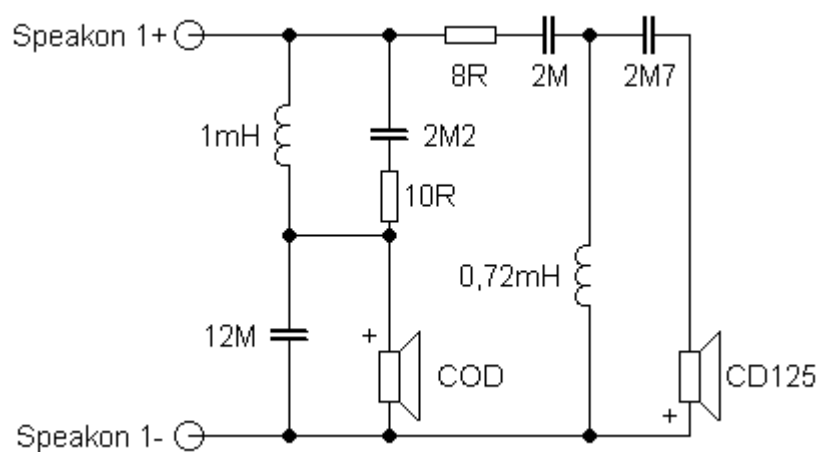

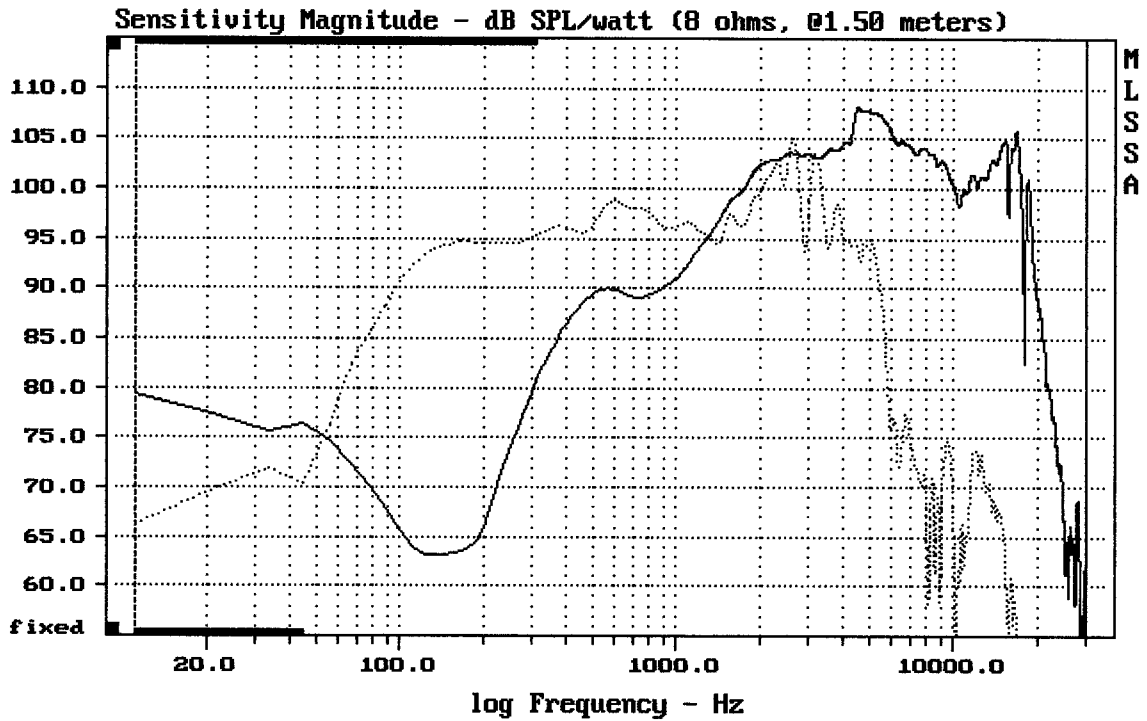

CURSOR:  $dy = -15.604$   $x = 30007.1014$  (2704)

12" CIARE COD + CD125 + HM17-25

MLSSA: Frequency Domain

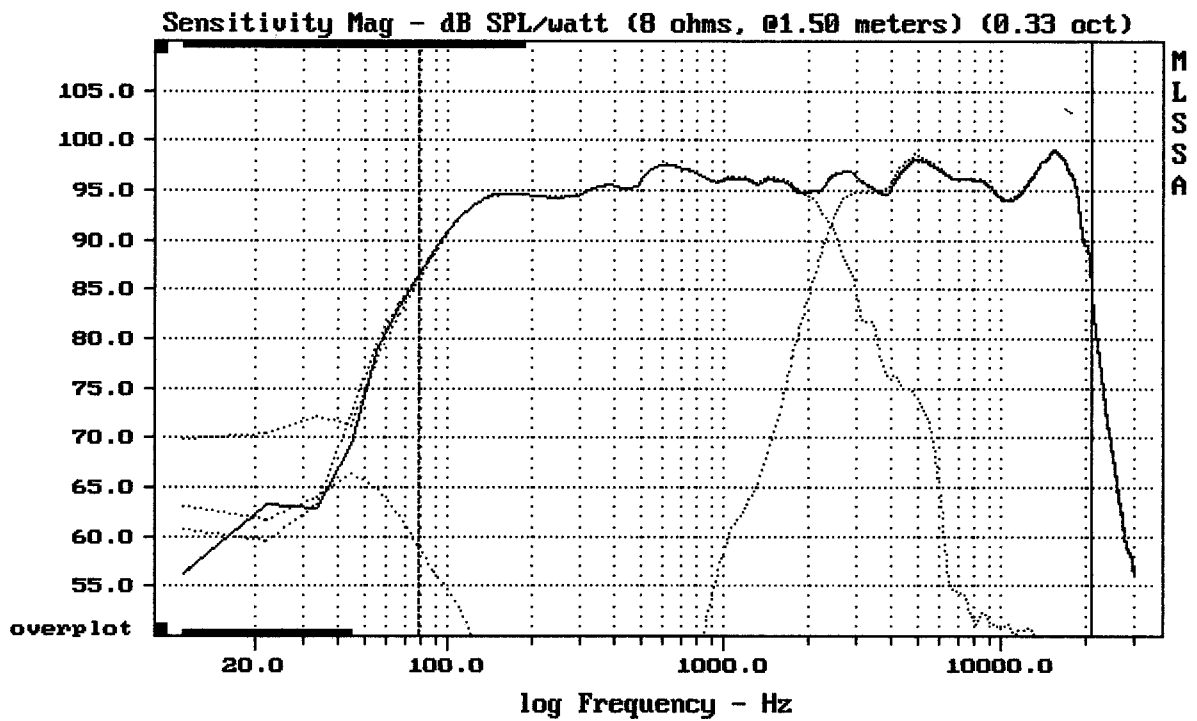

Level (78:21007 Hz) = 95.64 dB SPL/watt (8 ohms, @1.50 meters) (0.33 oct)

12" CIARE COD + CD125 + HM17-25

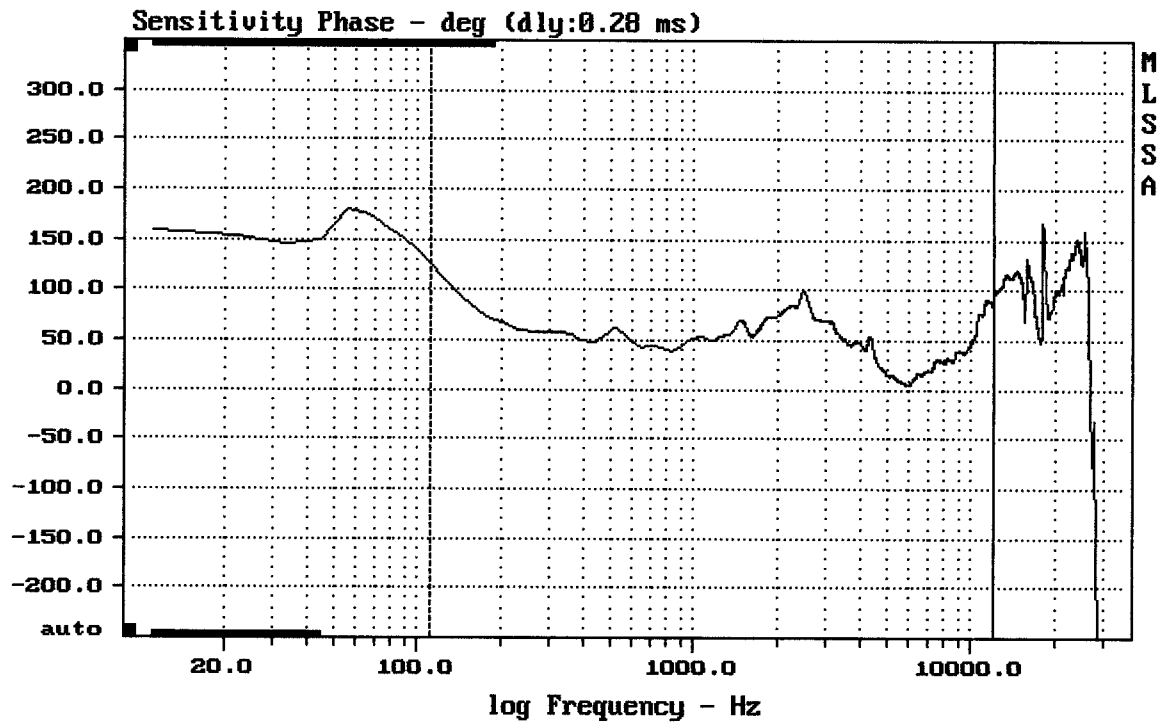

mean: 46.54, rms: 52.94, std: 25.22, max: 125.4, min: 4.765

12" CIARE COD + CD125 + HM17-25

MLSSA: Frequency Domain

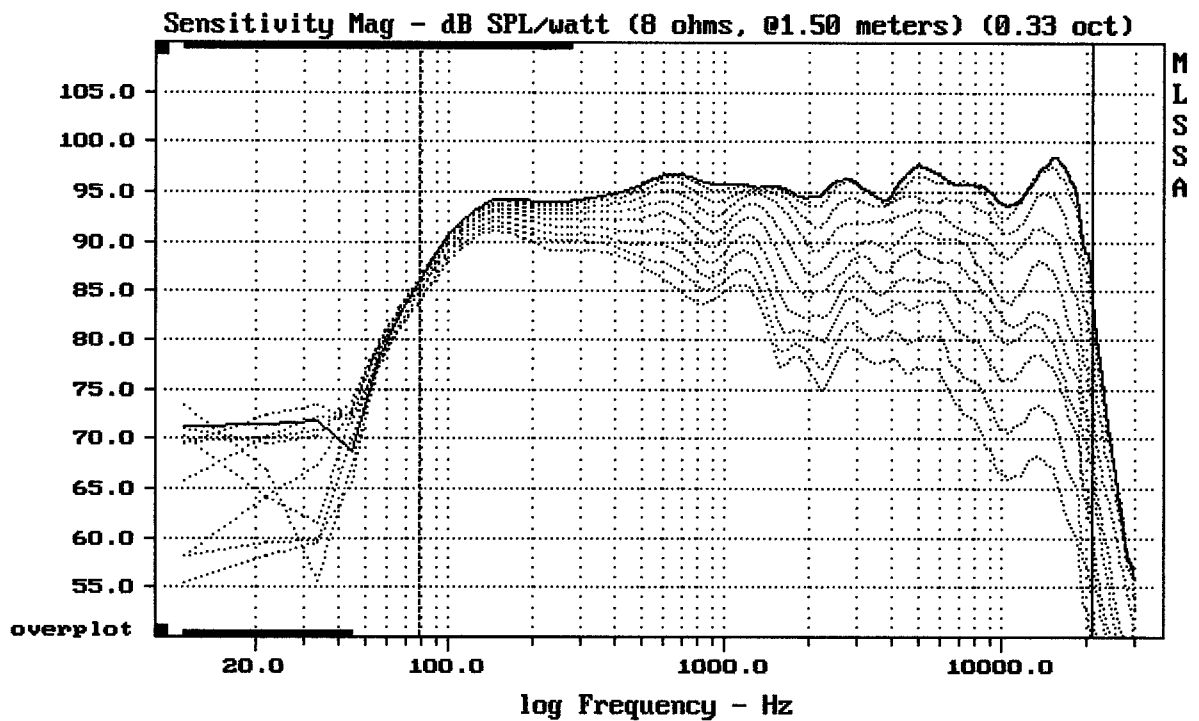

Overlay Compare: dev= +24/-11, std= 7.6, avg= -26

12" CIARE COD + CD125 + HM17-25

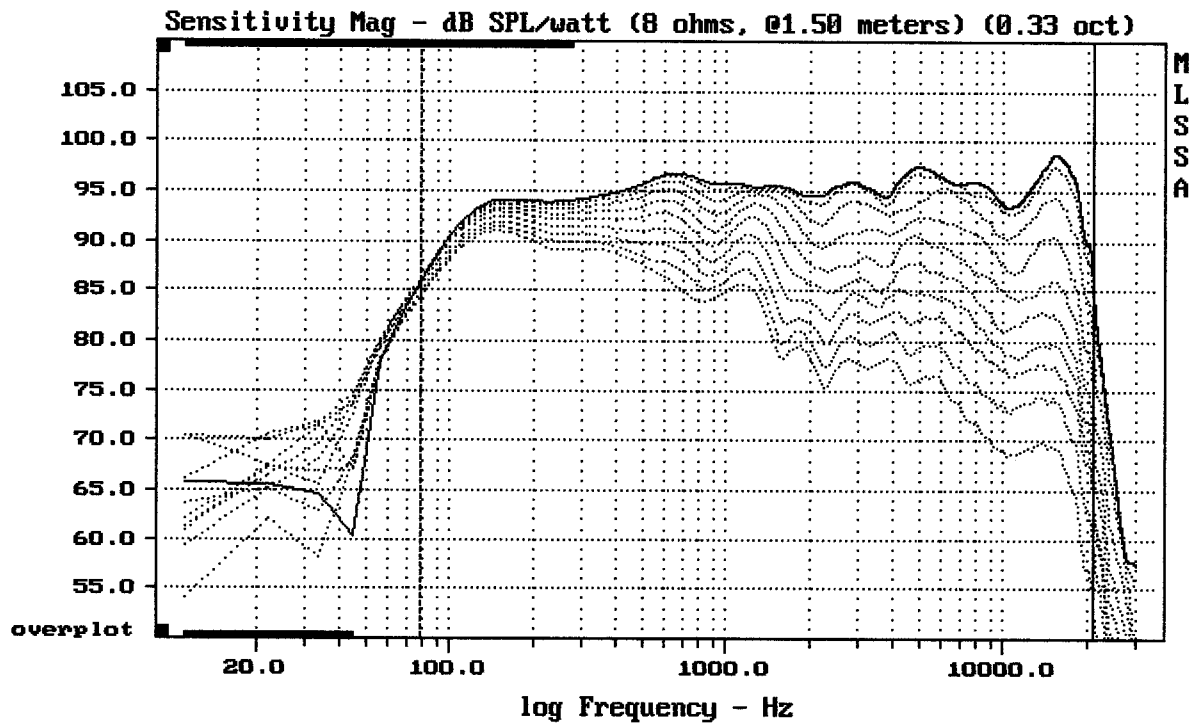

Overlay Compare: dev= +23/-8.6, std= 6.3, avg= -24

12" CIARE COD + CD125 + HM17-25

horna naležato

MLSSA: Frequency Domain

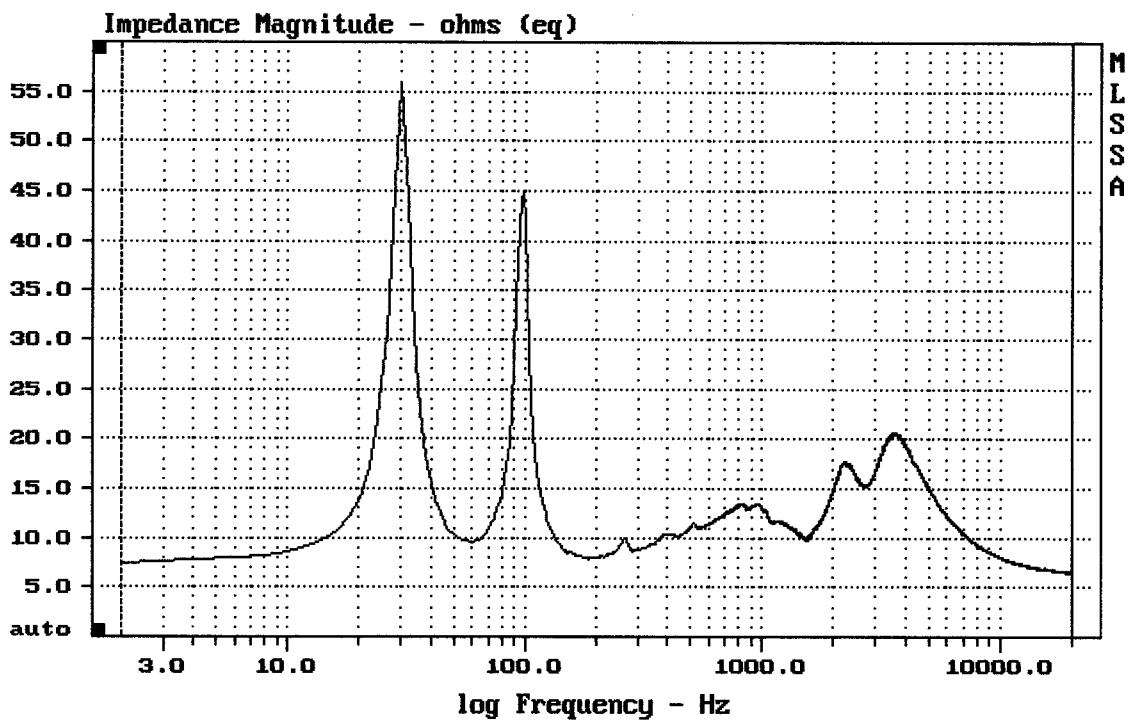

mean: 9.898, rms: 10.7, std: 4.065, max: 56, min: 6.432

12" CIARE COD + CD125 + HM17-25

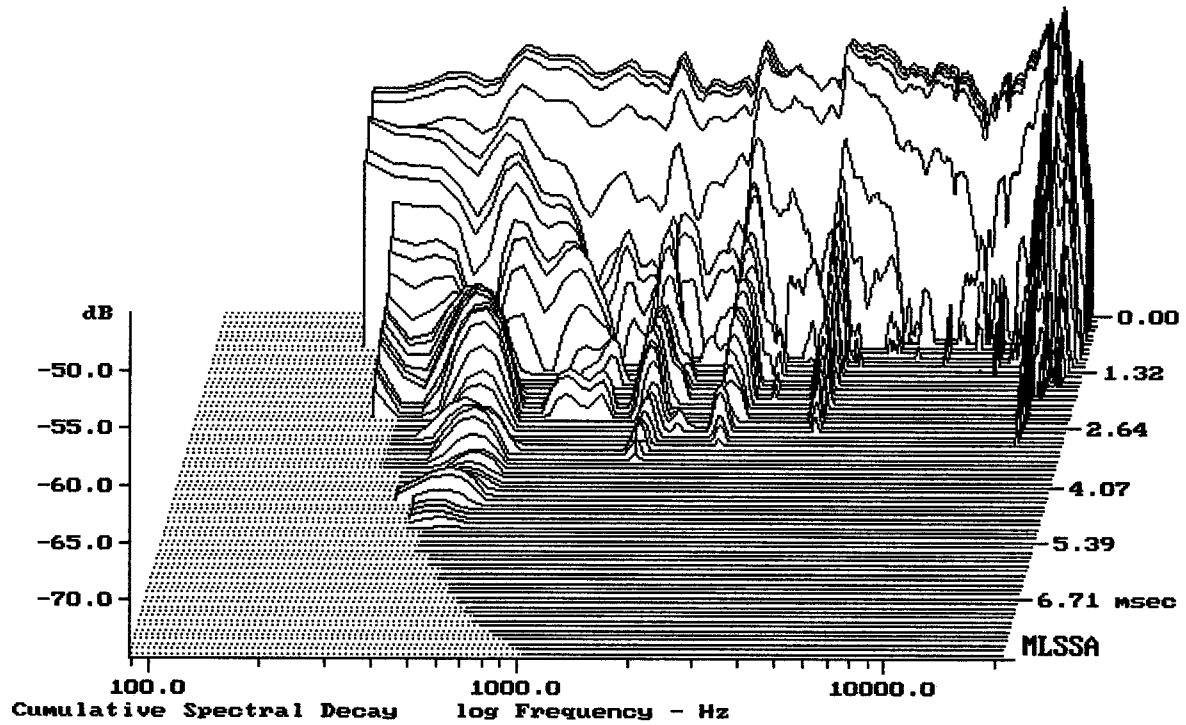

-73.81 dB, 1465 Hz (33), 3.300 msec (31)

DTTO

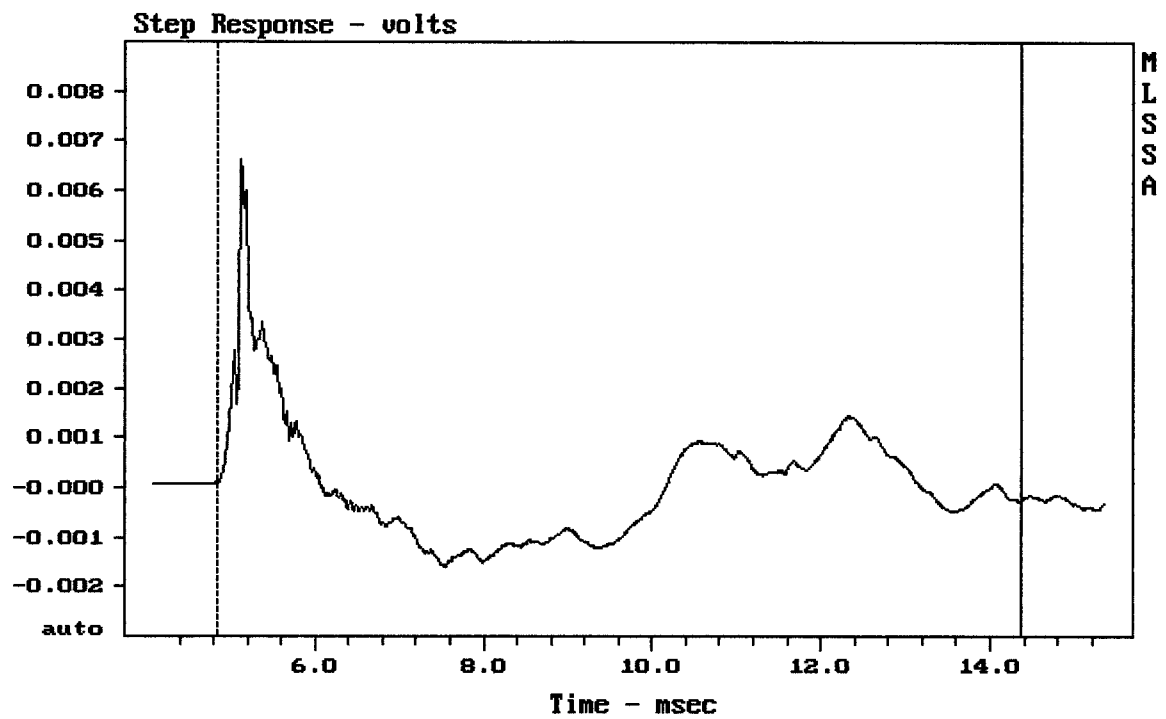

mean: 5.255e-005, rms: 0.001195, std: 0.001193, max: 0.006636, min: -0.001591

12" CIARE COD + CD125 + HM17-25

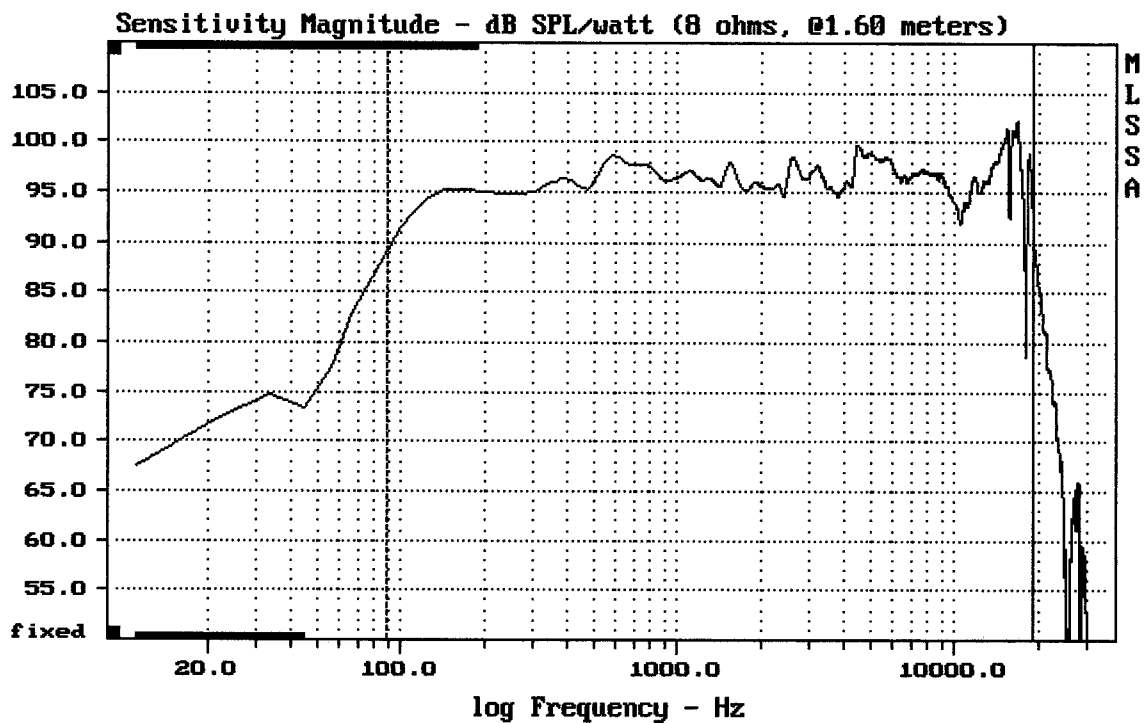



---

Level (89:19309 Hz) = 96.39 dB SPL/watt (8 ohms, @1.60 meters)

---

12" CIARE COD + CD125 + HM17-25

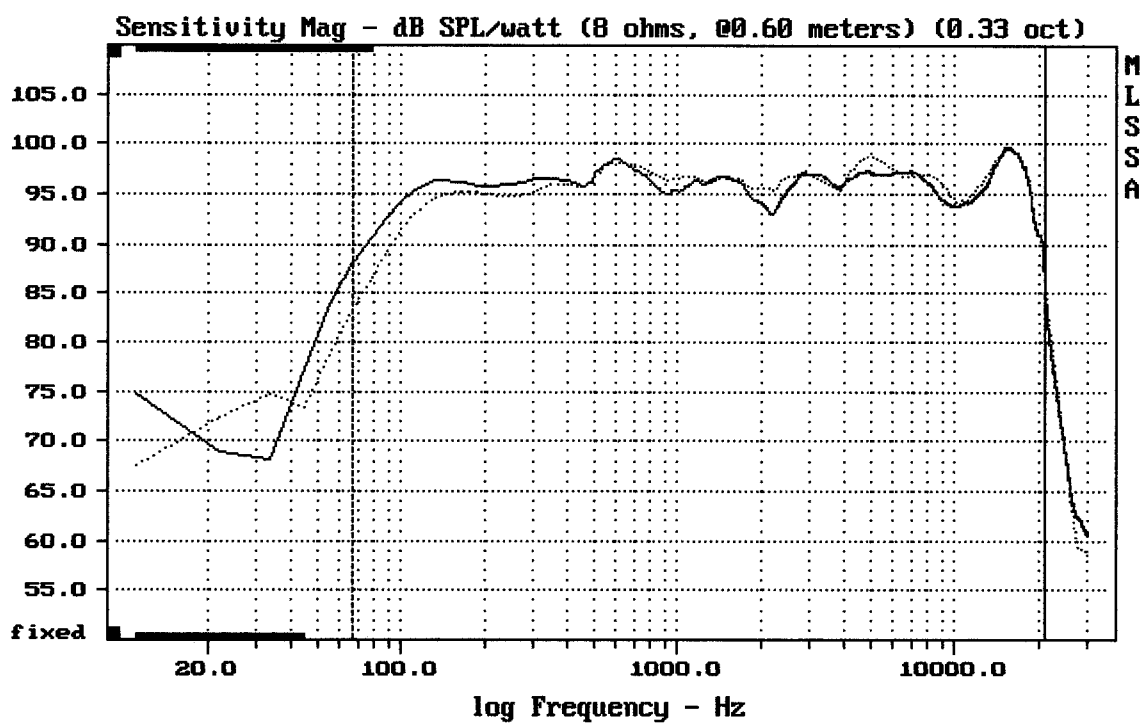
MLSSA: Frequency Domain



---

Overlay Compare: dev= +5.2/-2, std= 0.62, avg= -0.44

---

12" CIARE COD + CD125 + HM17-25

jiná vzdálenost - 0,6m