

## Sestava Fane Colossus 12MB + CD150 + FH305

### Osazení:

- Fane Colossus 12MB 8/Ohm

<http://eshop.prodance.cz/DetailPage.asp?DPG=85020>

- Fane CD150 8/Ohm

<http://eshop.prodance.cz/DetailPage.asp?DPG=90670>

- Fane FH305

<http://eshop.prodance.cz/DetailPage.asp?DPG=81783>

### Schéma výhybky:

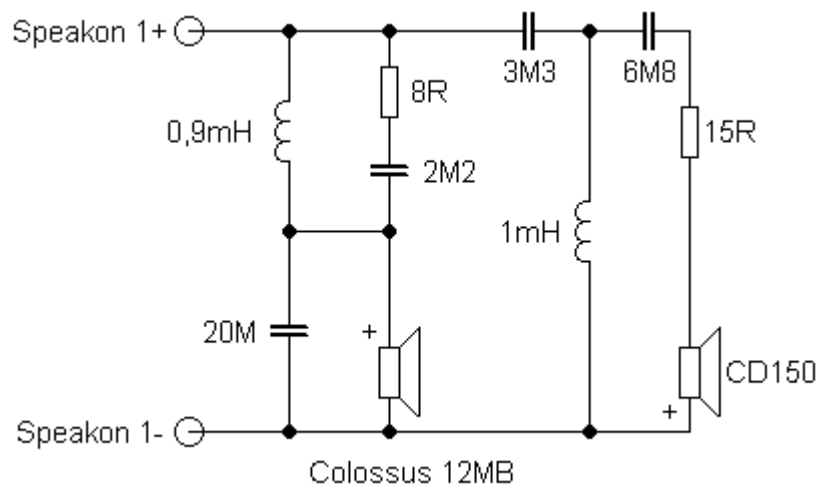

**Varianta I.**

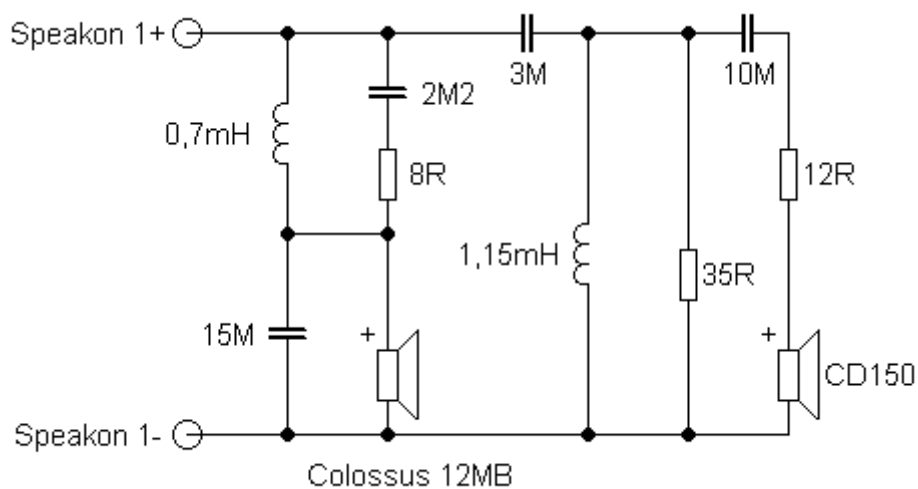

**Varianta II.**

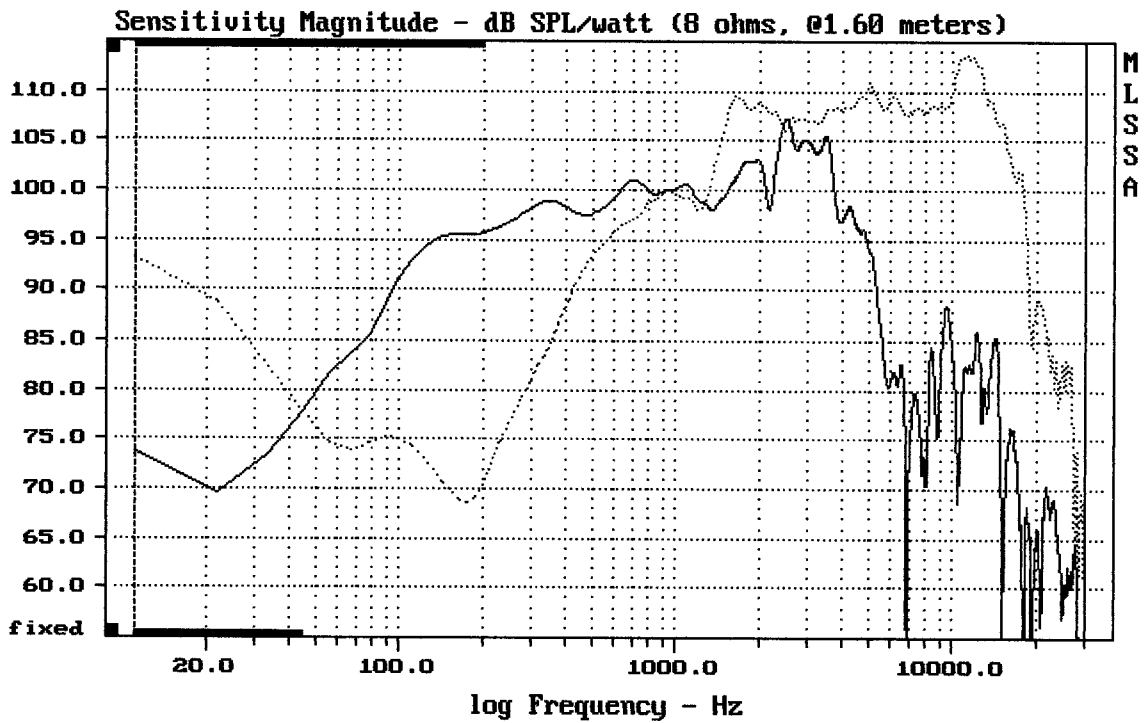

CURSOR: dy = 16.433 x = 30007.1014 (2704)

COL12MB + CD150 + FH305

MLSSA: Frequency Domain

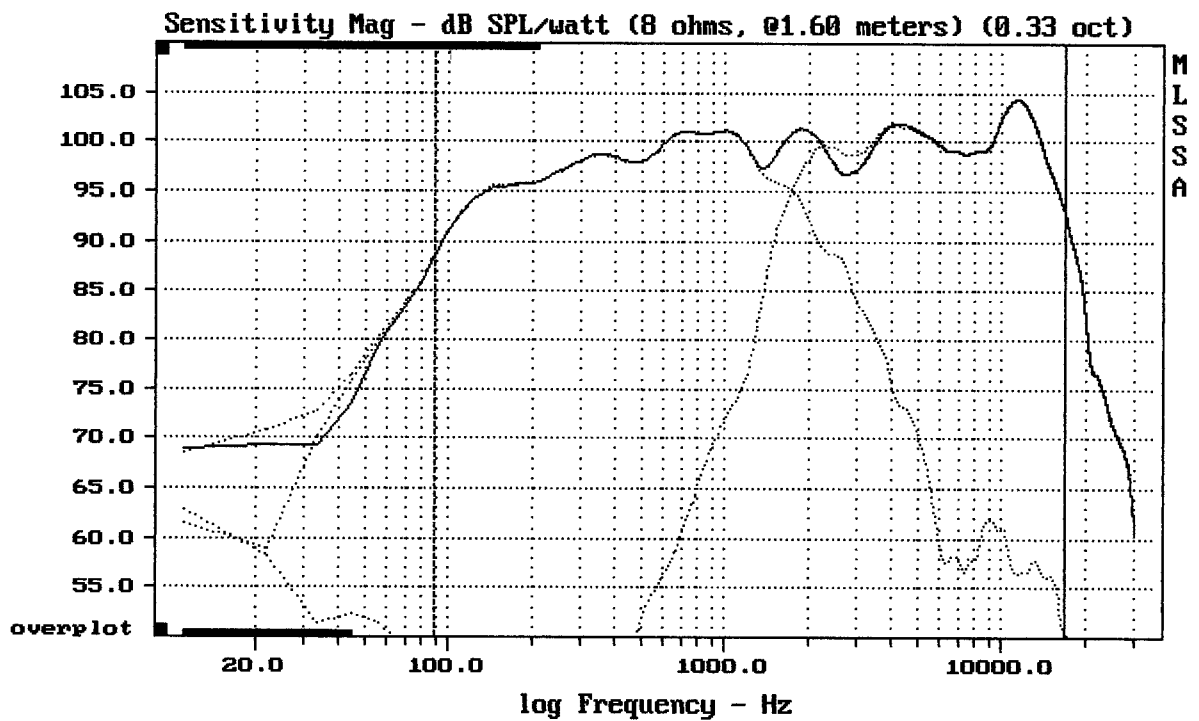

Level (89:17001 Hz) = 99.33 dB SPL/watt (8 ohms, @1.60 meters) (0.33 oct)

COL12MB + CD150 + FH305

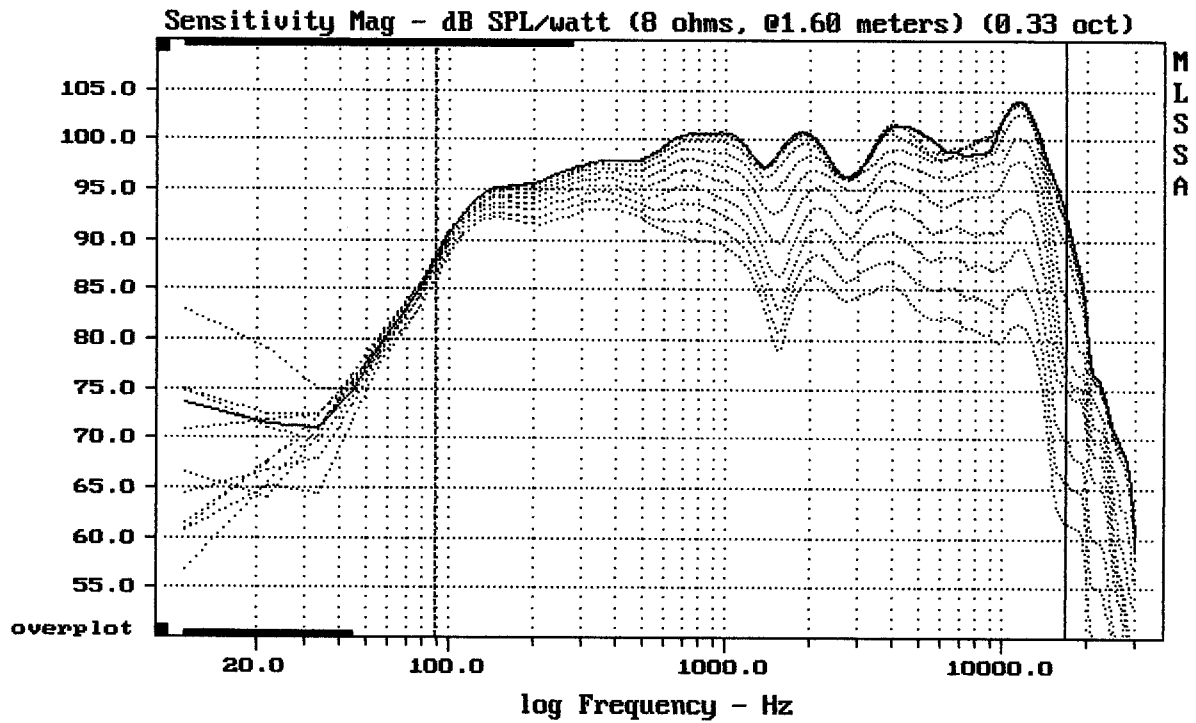

Overlay Compare: dev= +18/-12, std= 6.2, avg= -20

COL12MB + CD150 + FH305

MLSSA: Frequency Domain

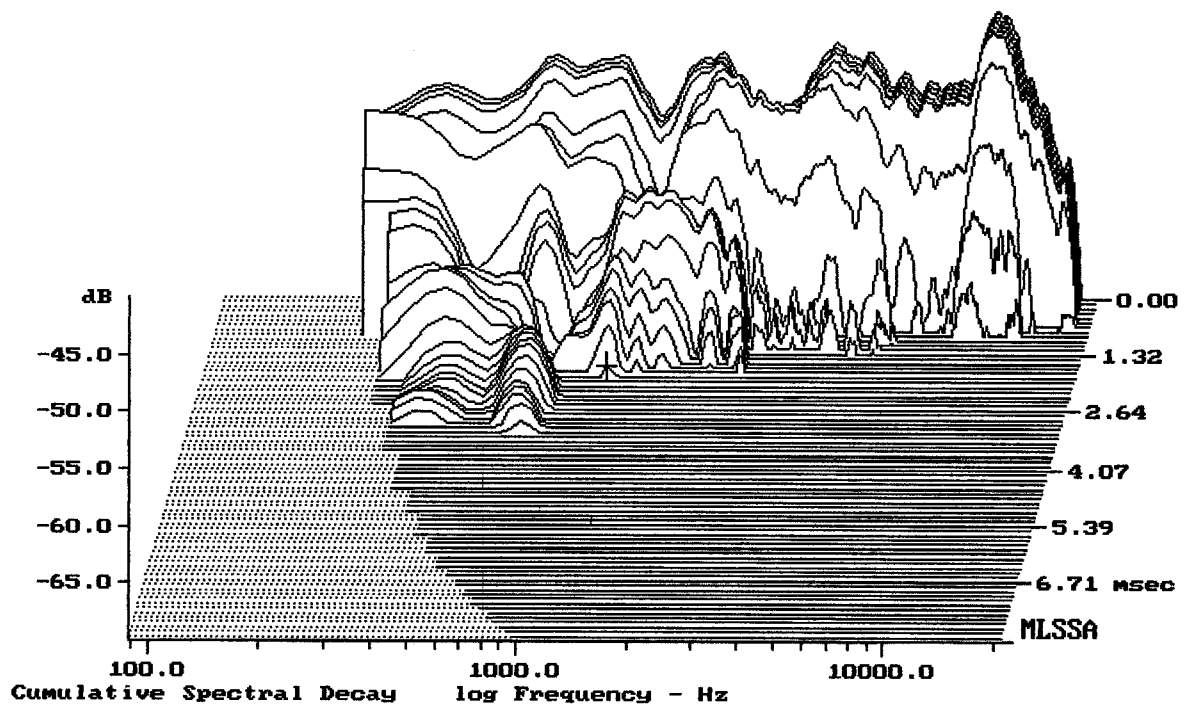

-69.08 dB, 1110 Hz (25), 1.870 msec (18)

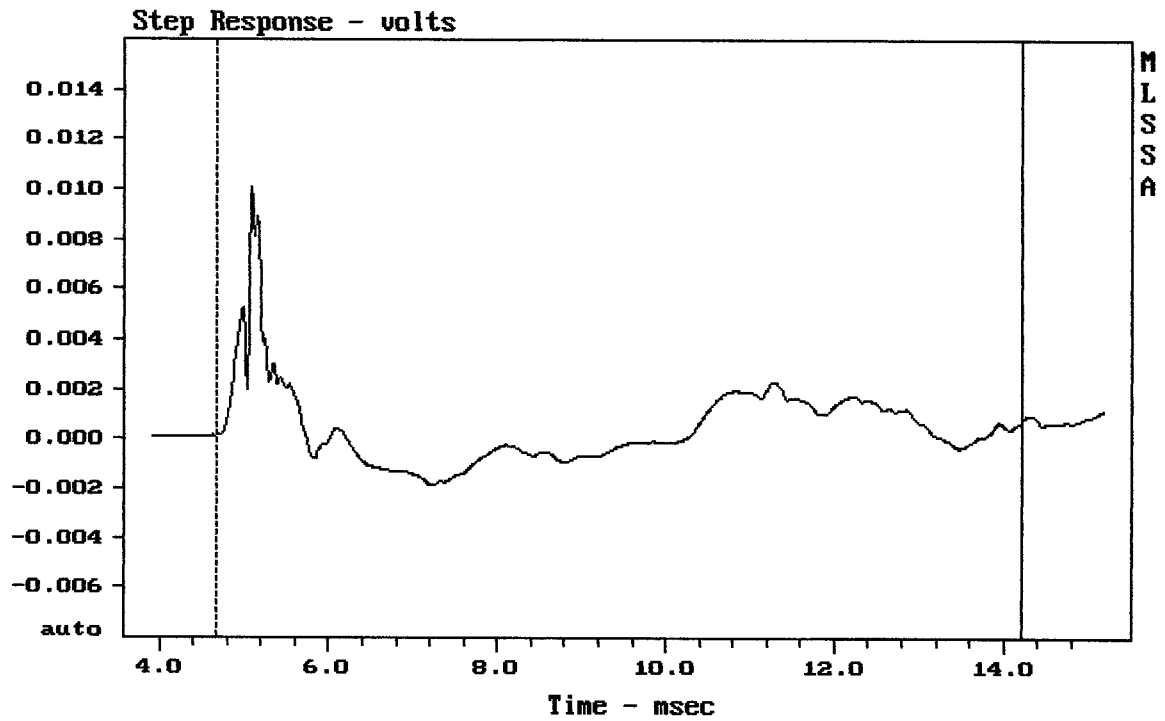

MLSSA: Time Domain

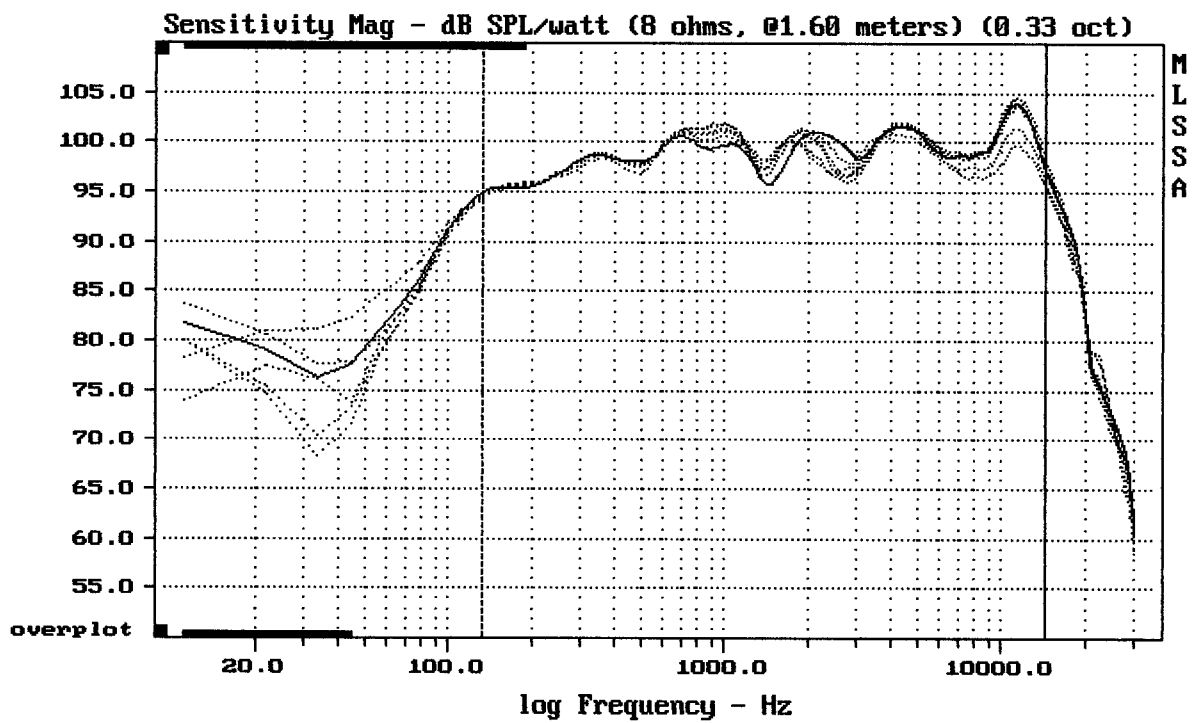

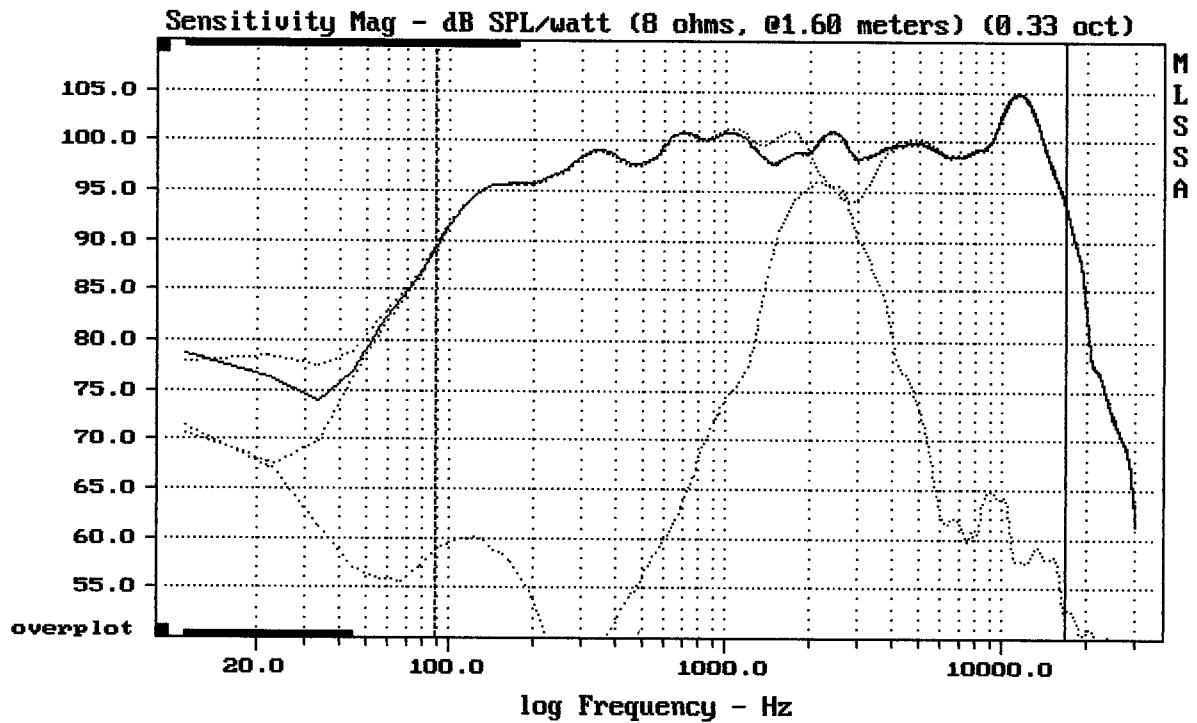



---

Level (89:17001 Hz) = 99.10 dB SPL/watt (8 ohms, @1.60 meters) (0.33 oct)

---

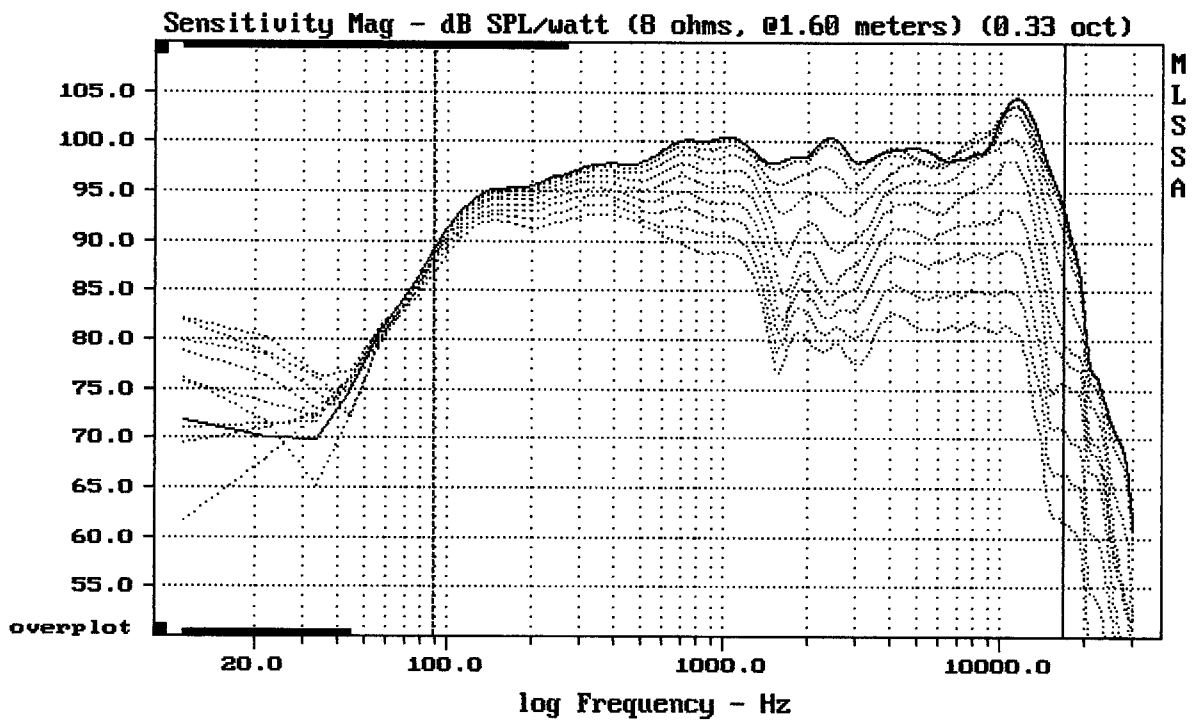
MLSSA: Frequency Domain





---

Overlay Compare: dev= +19/-12, std= 6.9, avg= -22

---

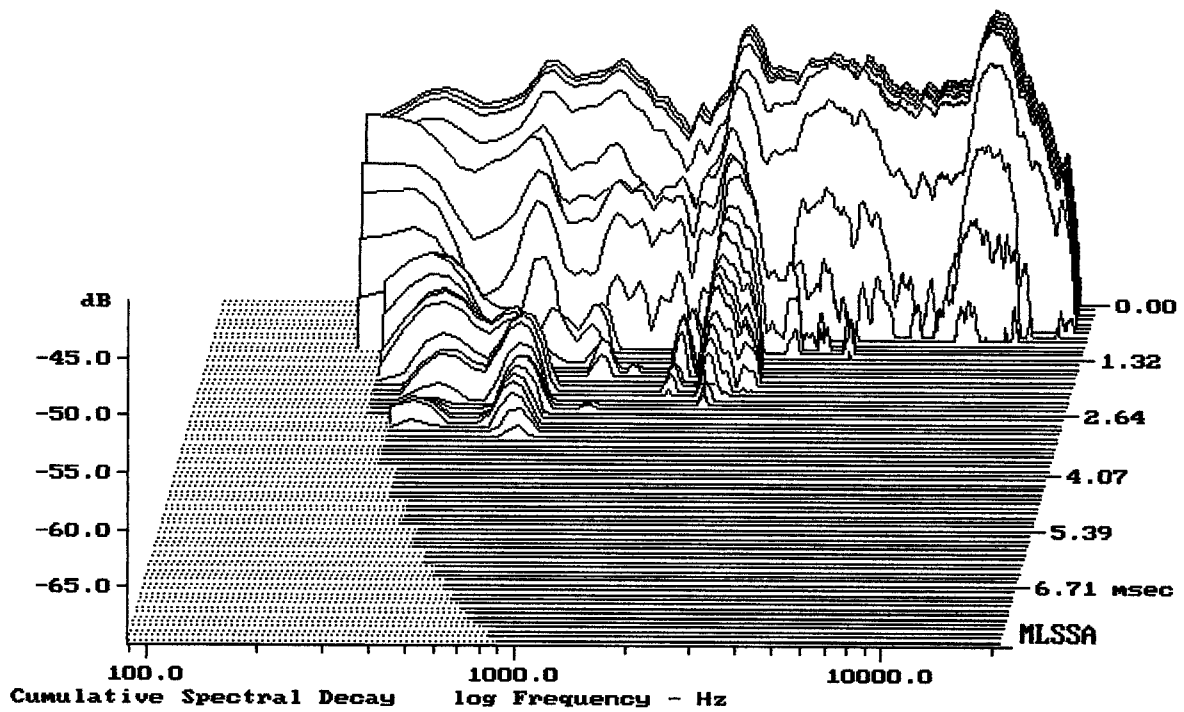
COL12MB + CD150 + FH305



-68.61 dB, 2131 Hz (48), 2.310 msec (22)

DTTO

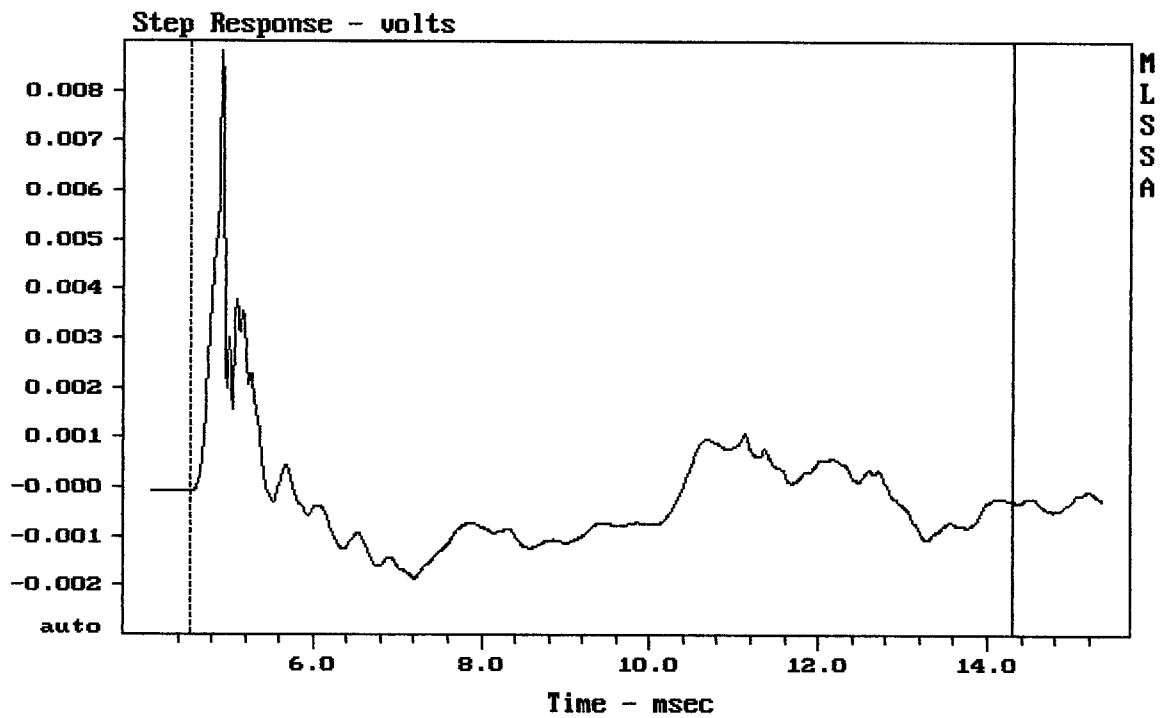

mean: -0.0002024, rms: 0.001259, std: 0.001243, max: 0.008792, min: -0.00186

COL12MB + CD150 + FH305

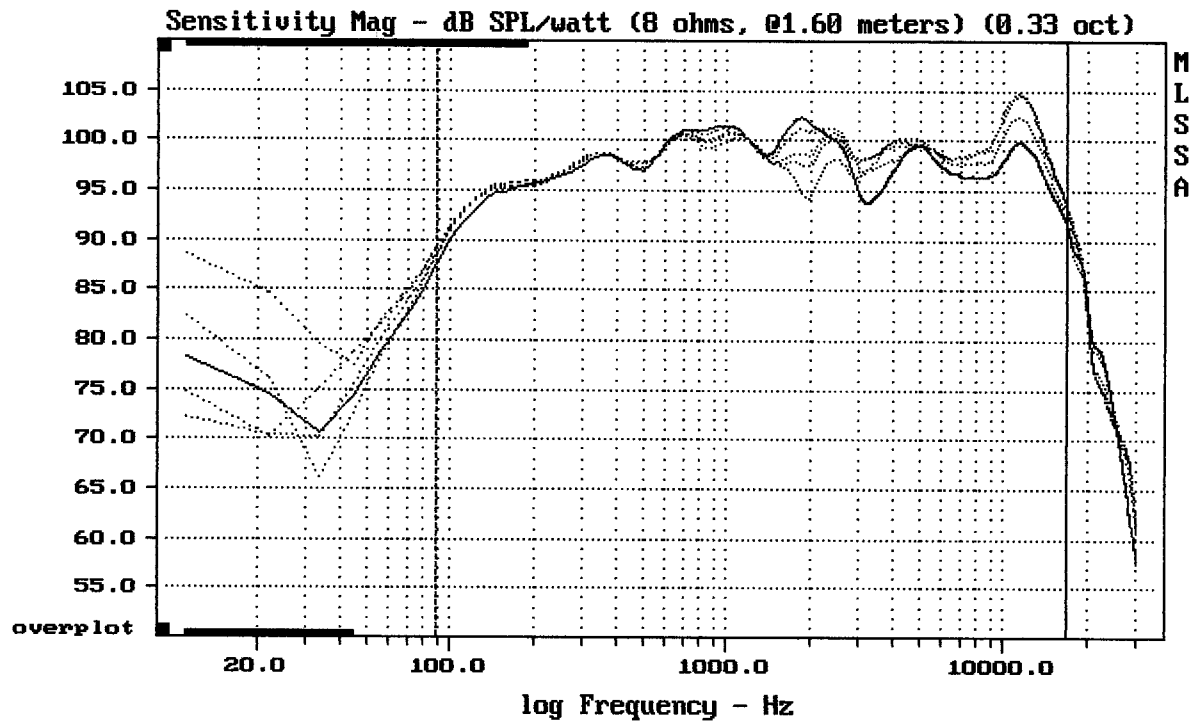

---

mean: 99.78, rms: 100.24, std: 2.51, max: 104.66, min: 89.31

---

COL12MB + CD150 + FH305

Varianta II.

MLSSA: Frequency Domain

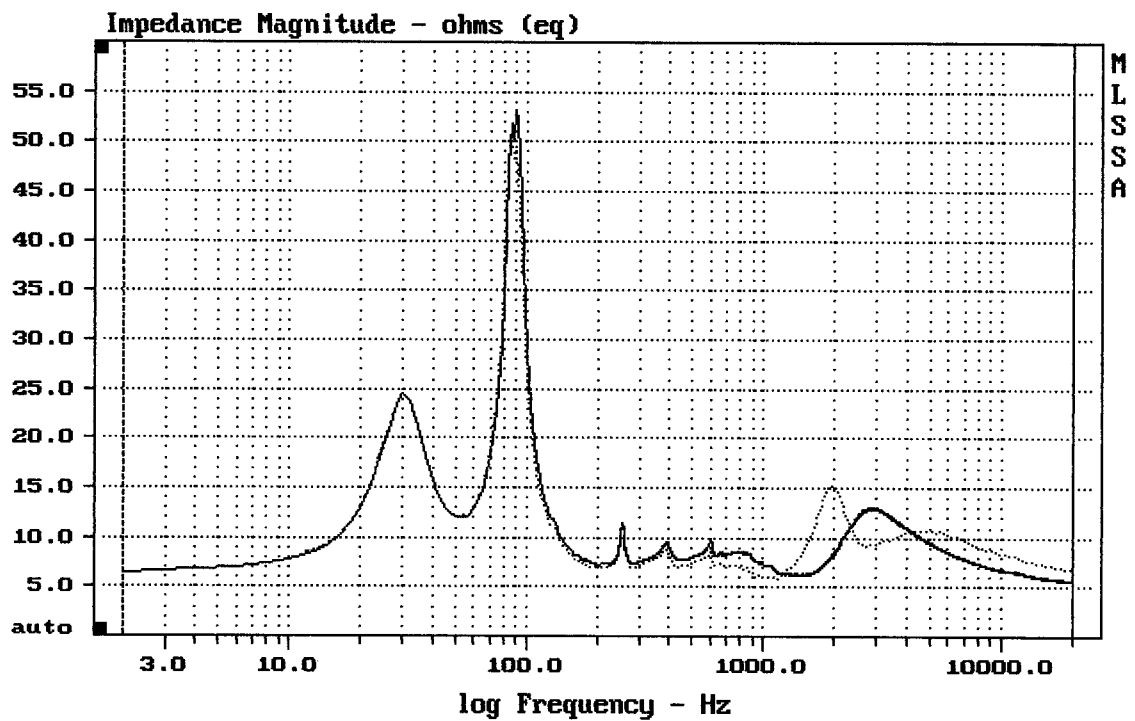

---

mean: 8.604, rms: 8.847, std: 2.06, max: 50.58, min: 5.835

---

DTTO I/II ...../—