

Sestava Eminence Delta-15 + Selenium D220Ti OMF + Megaton
A9090

Osazení:

- Eminence Delta-15 8/Ohm

<http://eshop.prodance.cz/DetailPage.asp?DPG=82362>

- Selenium D220Ti OMF 8/Ohm

<http://eshop.prodance.cz/DetailPage.asp?DPG=90768>

- Megaton A9090

<http://eshop.prodance.cz/DetailPage.asp?DPG=83920>

Schéma výhybky:

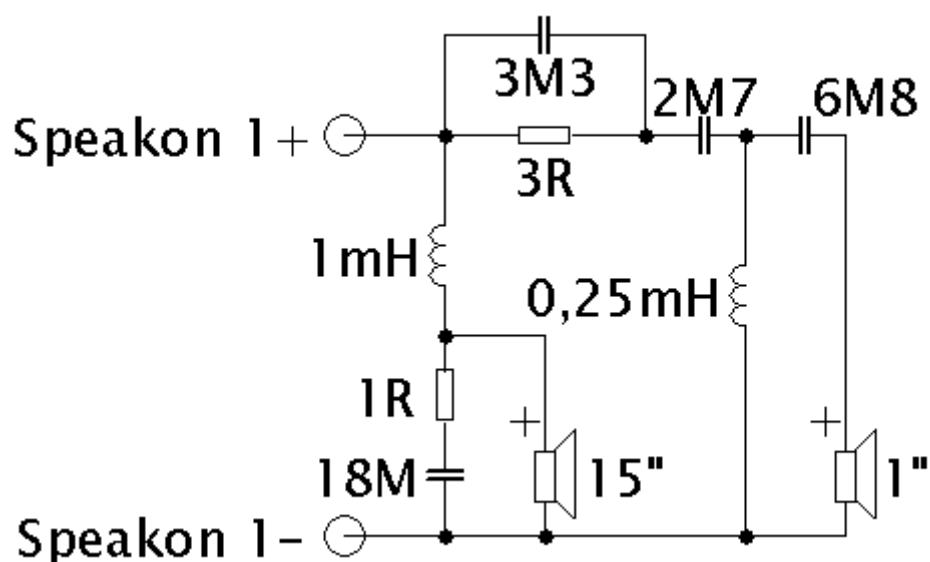

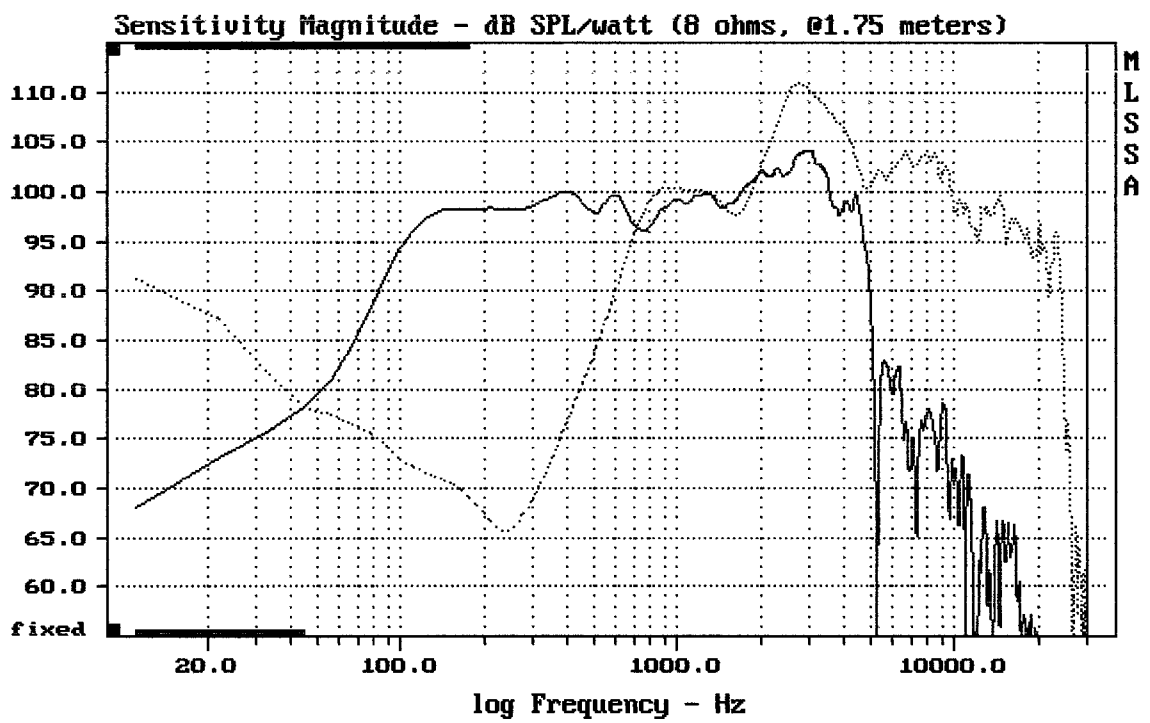

CURSOR: dy = 19.885 x = 30007.1014 (2704)

DELTA15 + D220TI OMF + A9090

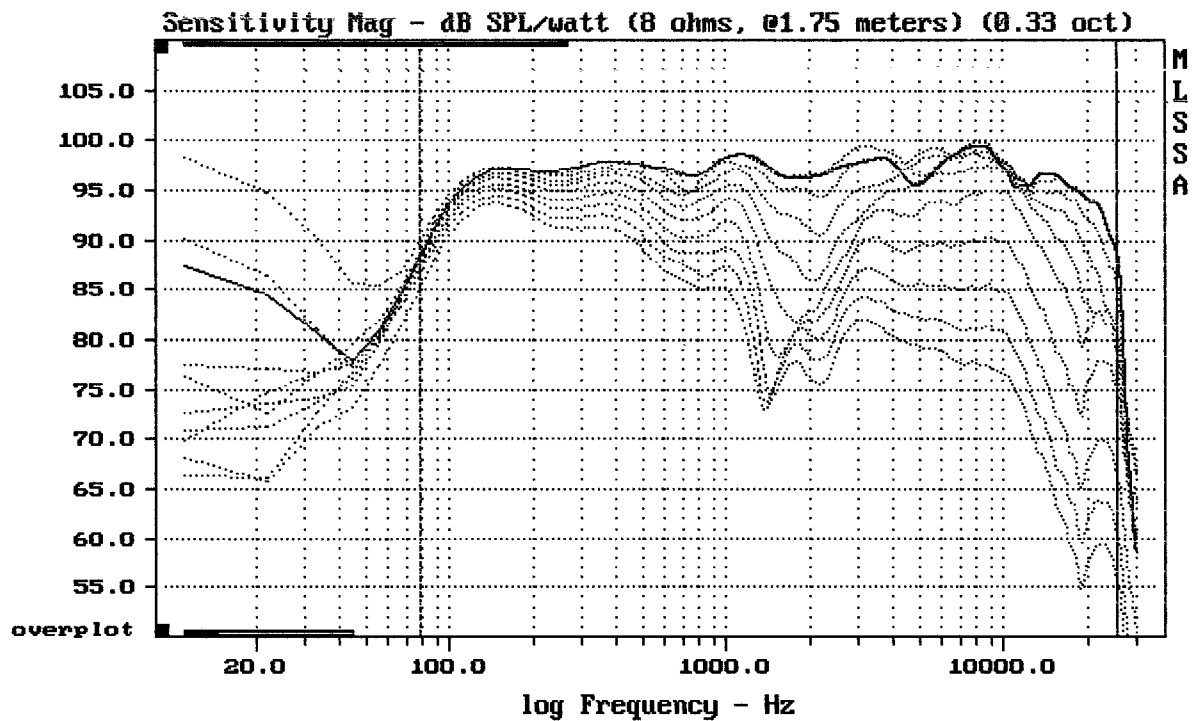

Overlay Compare: dev= +23/-13, std= 8.2, avg= -27

DELTA15 + D220T1 OMF + A9090

MLSSA: Frequency Domain

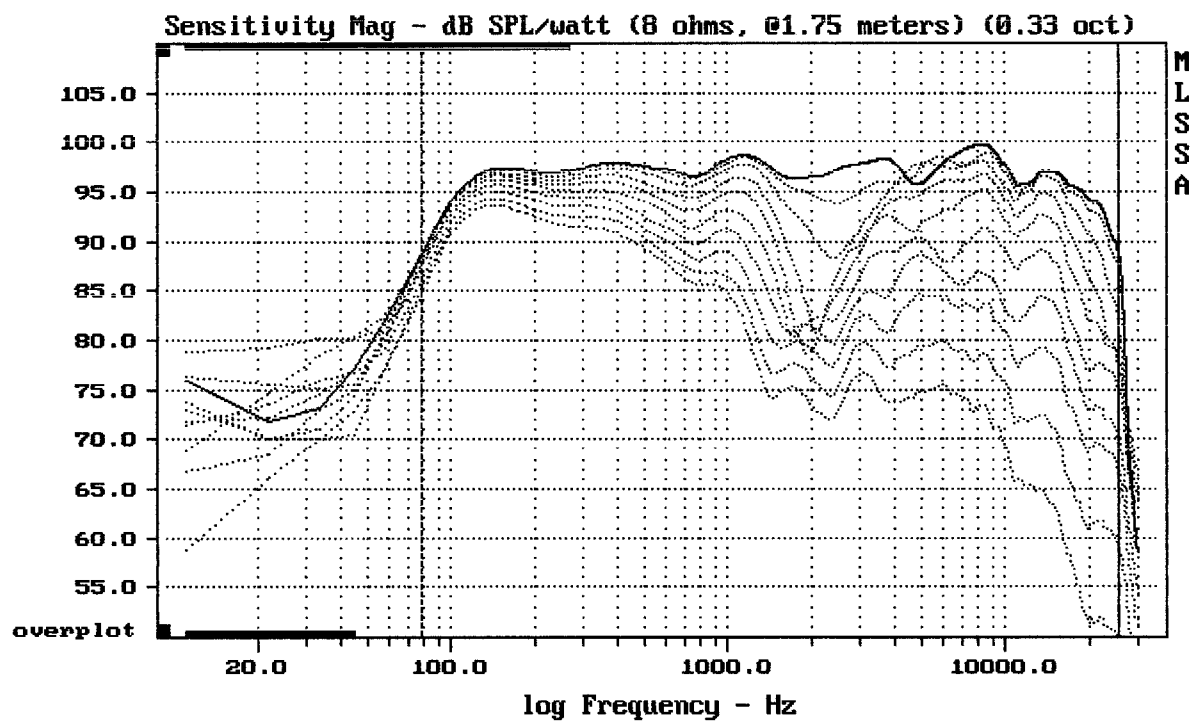

Overlay Compare: dev= +28/-11, std= 8.7, avg= -31

DELTA15 + D220T1 OMF + A9090

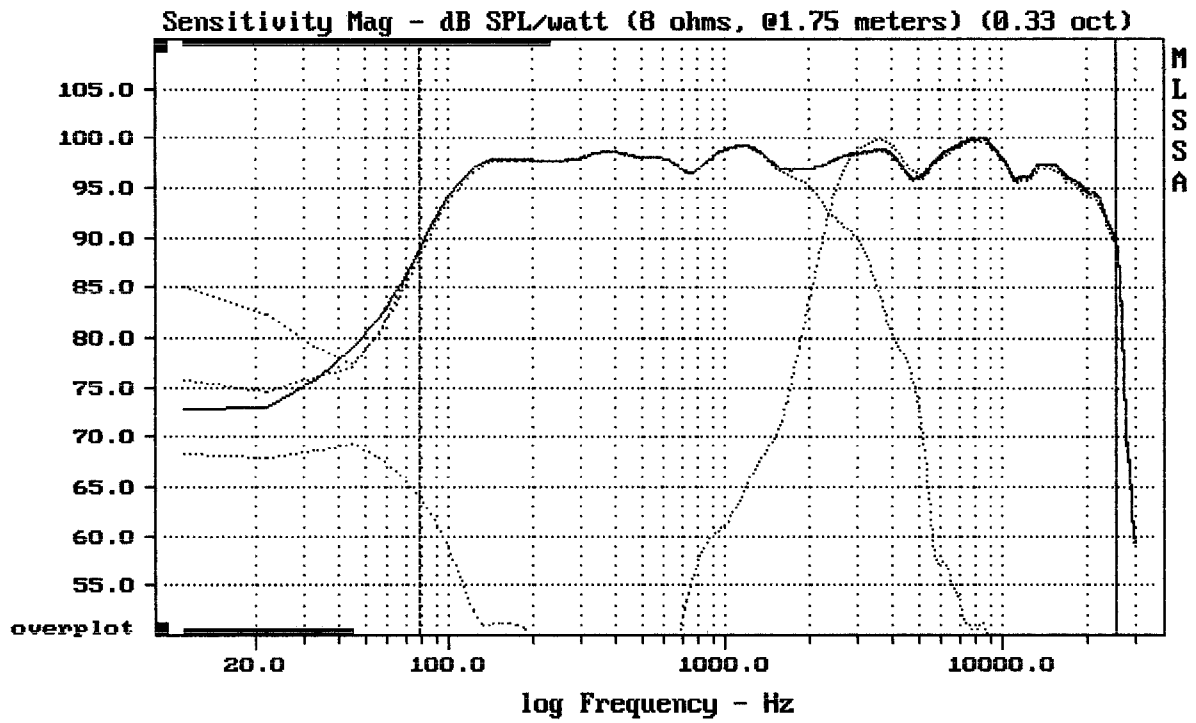

Level (78:25502 Hz) = 97.46 dB SPL/watt (8 ohms, @1.75 meters) (0.33 oct)

DELTA15 + D220TI OMF + A9090

MLSSA: Frequency Domain

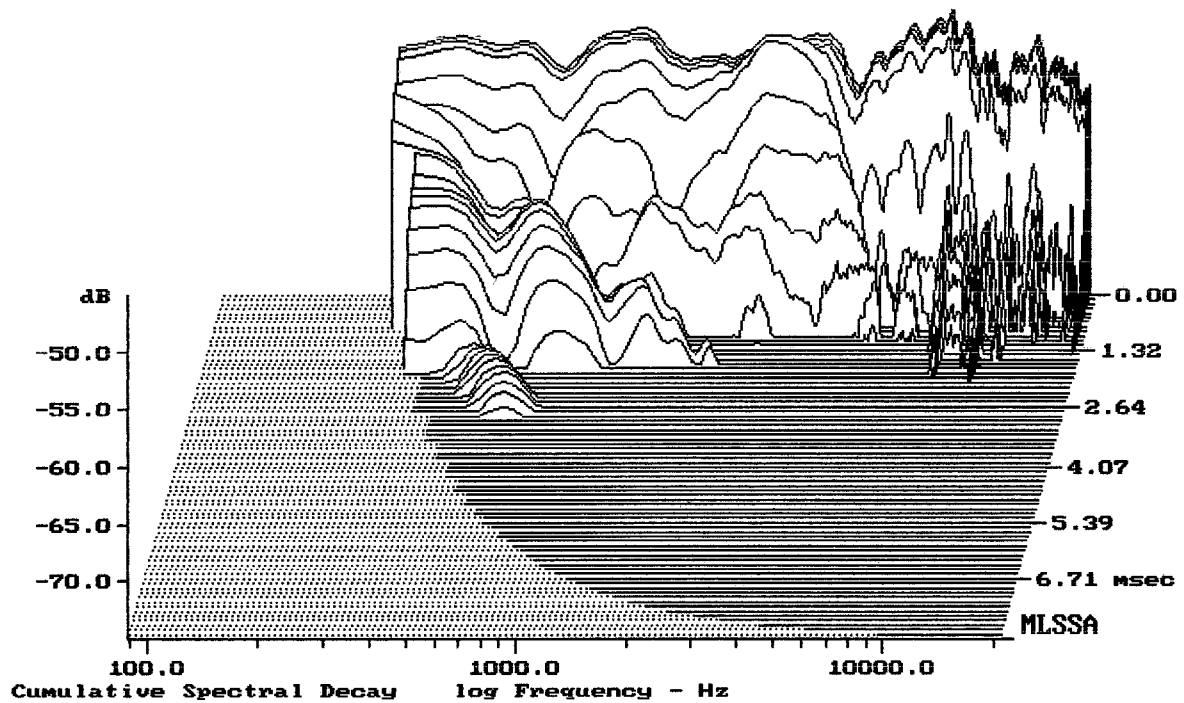

-73.98 dB, 10964 Hz (247), 1.980 msec (19)

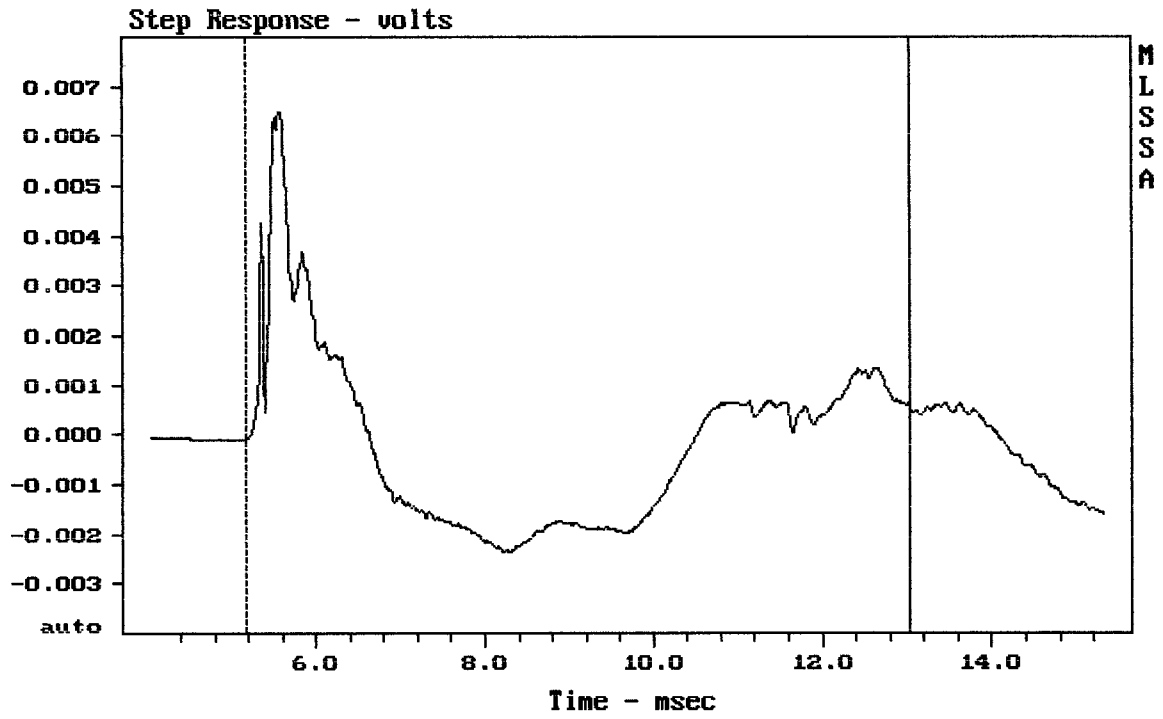

mean: -0.0001739, rms: 0.001779, std: 0.00177, max: 0.006495, min: -0.00238

DELTA15 + D220TI OMF + A9090

MLSSA: Time Domain

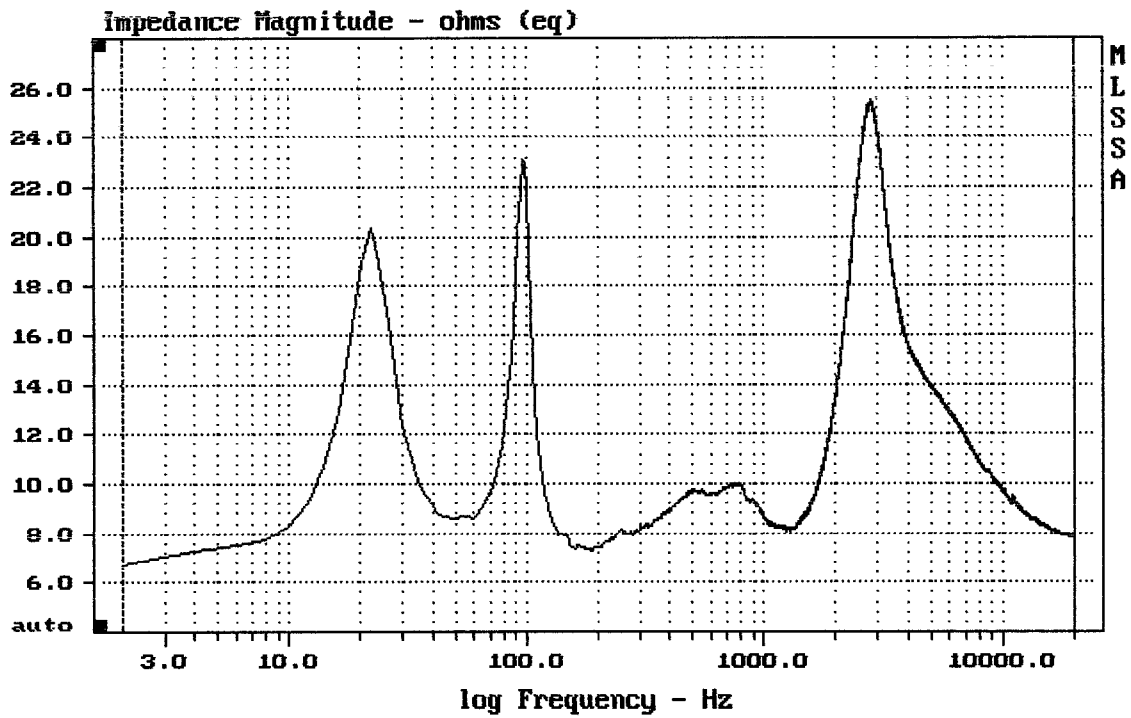

mean: 10.79, rms: 11.44, std: 3.81, max: 25.54, min: 6.757

DELTA15 + D220TI OMF + A9090