

Sestava Eminence Delta-15 + Fane CD140 + Megaton A8080

Osazení:

- Eminence Delta-15 8/Ohm

<http://eshop.prodance.cz/DetailPage.asp?DPG=82362>

- Fane CD140 8/Ohm

<http://eshop.prodance.cz/DetailPage.asp?DPG=90663>

- Megaton A8080

<http://eshop.prodance.cz/DetailPage.asp?DPG=83916>

Schéma výhybky:

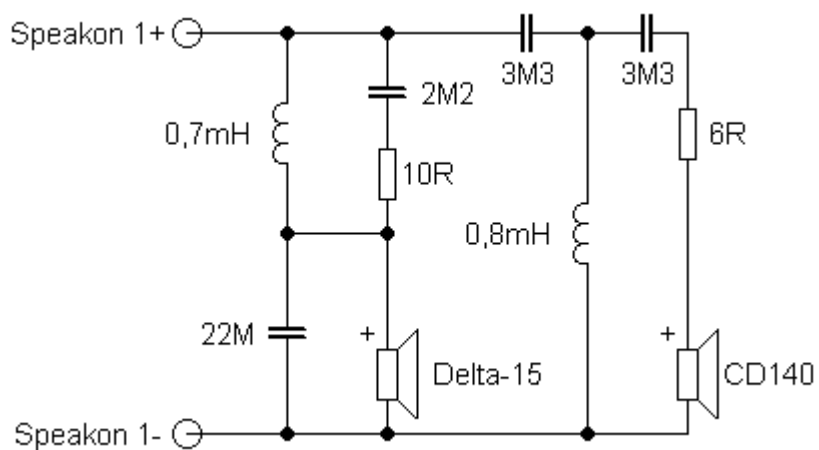

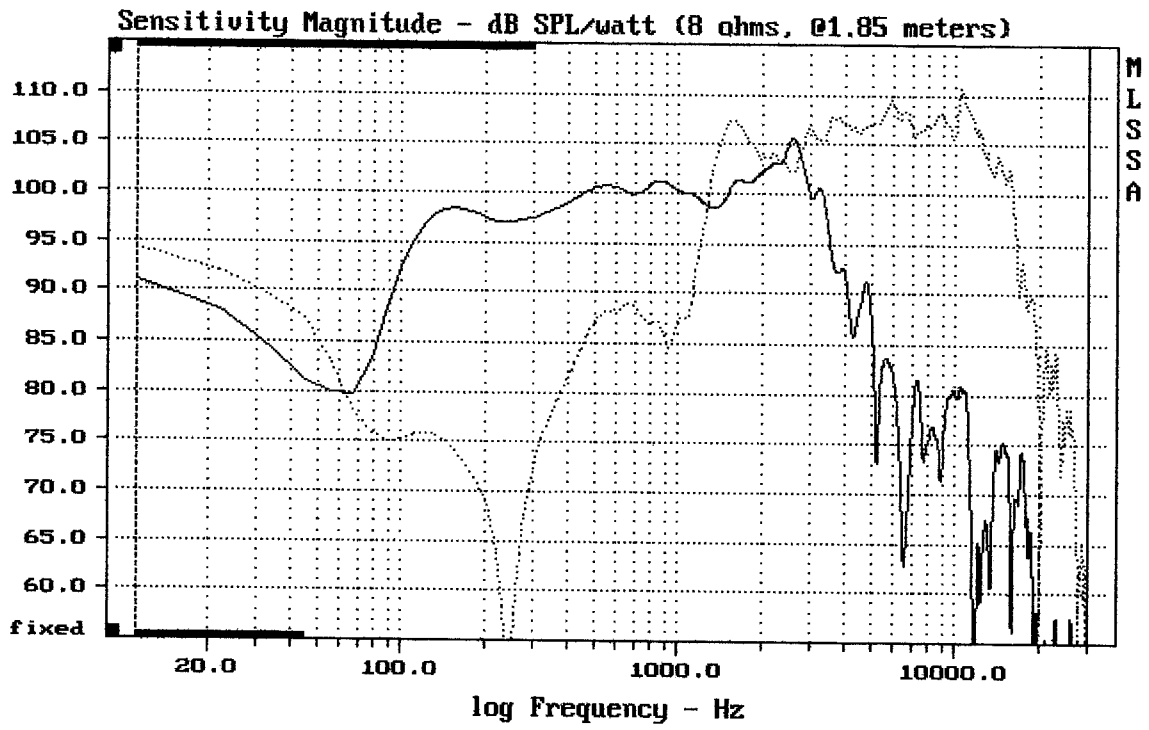

CURSOR: $\Delta y = 18.932$ $x = 30007.1014$ (2704)

DELTA 15 + CD140NEW + A8080

MLSSA: Frequency Domain

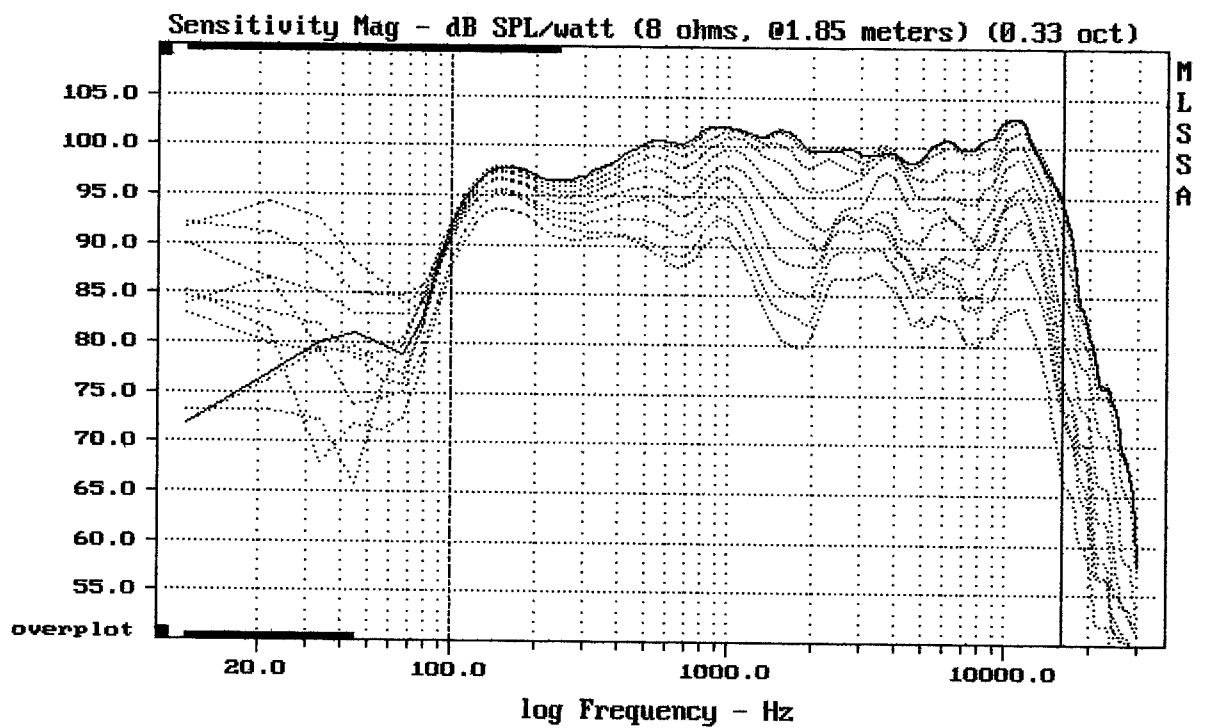

Overlay Compare: $\text{dev} = +14/-9.4$, $\text{std} = 4$, $\text{avg} = -18$

DELTA 15 + CD140NEW + A8080

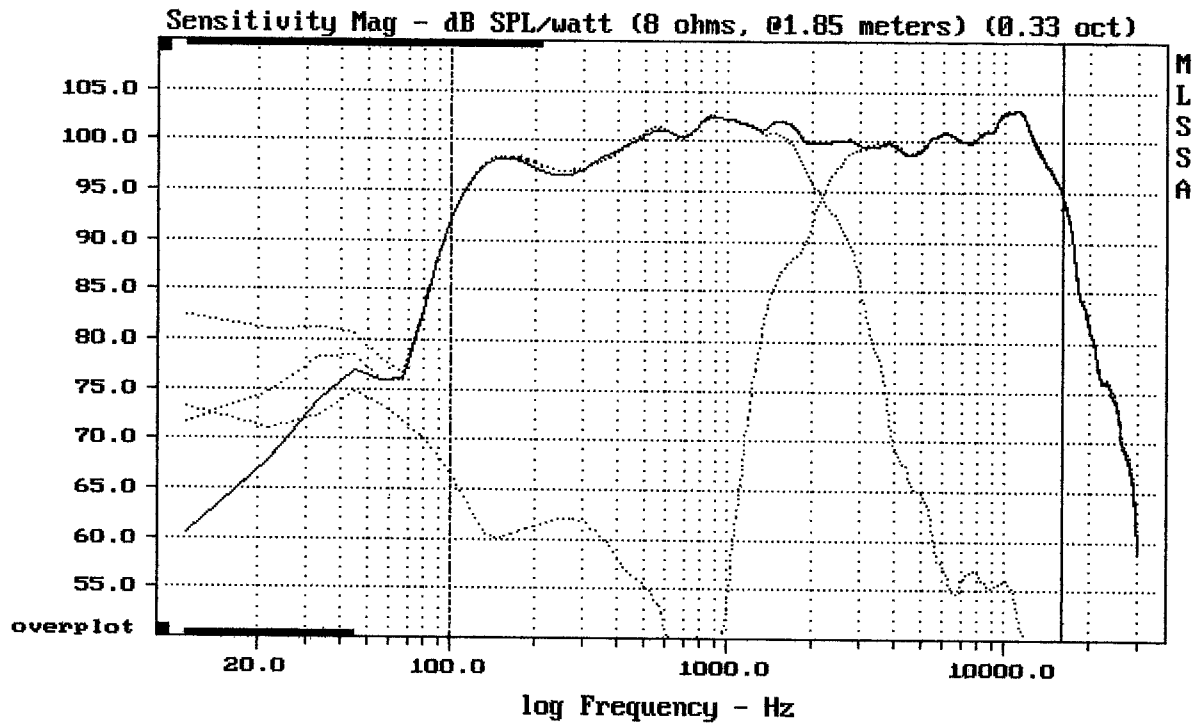

Level (100:16002 Hz) = 100.02 dB SPL/watt (8 ohms, @1.85 meters) (0.33 oct)

DELTA 15 + CD140NEW + A8000

MLSSA: Frequency Domain

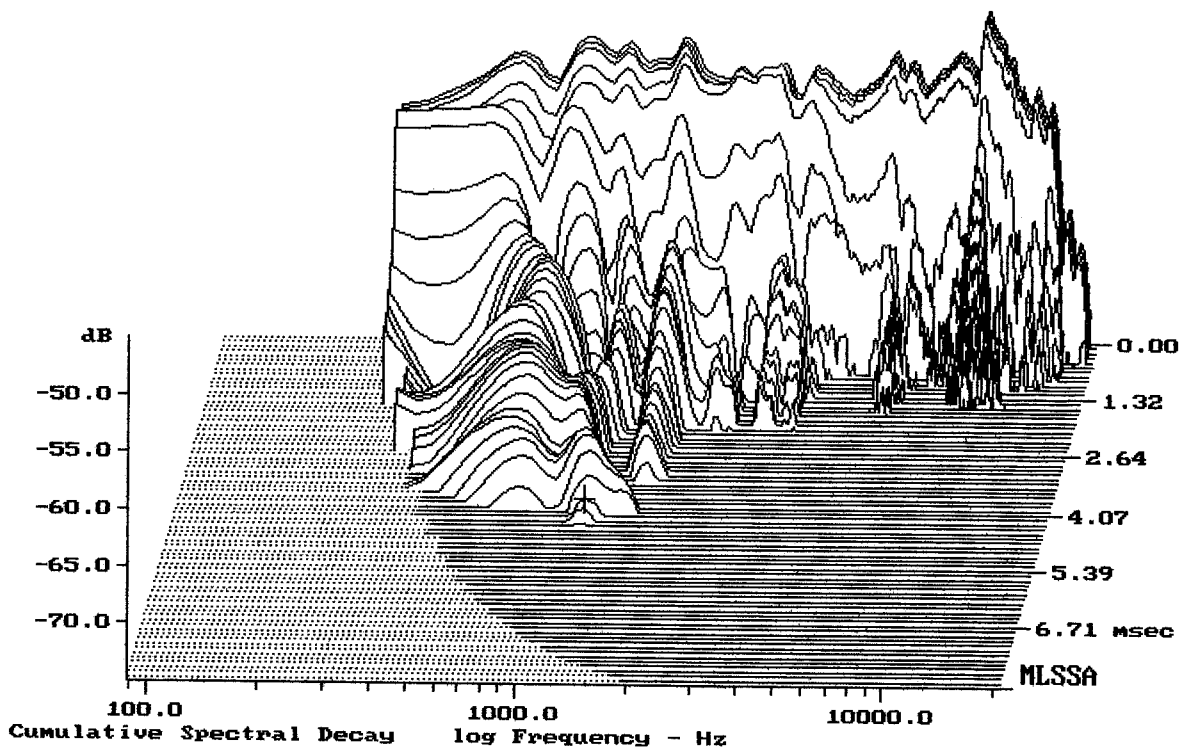

-73.38 dB, 1154 Hz (26), 4.180 msec (39)

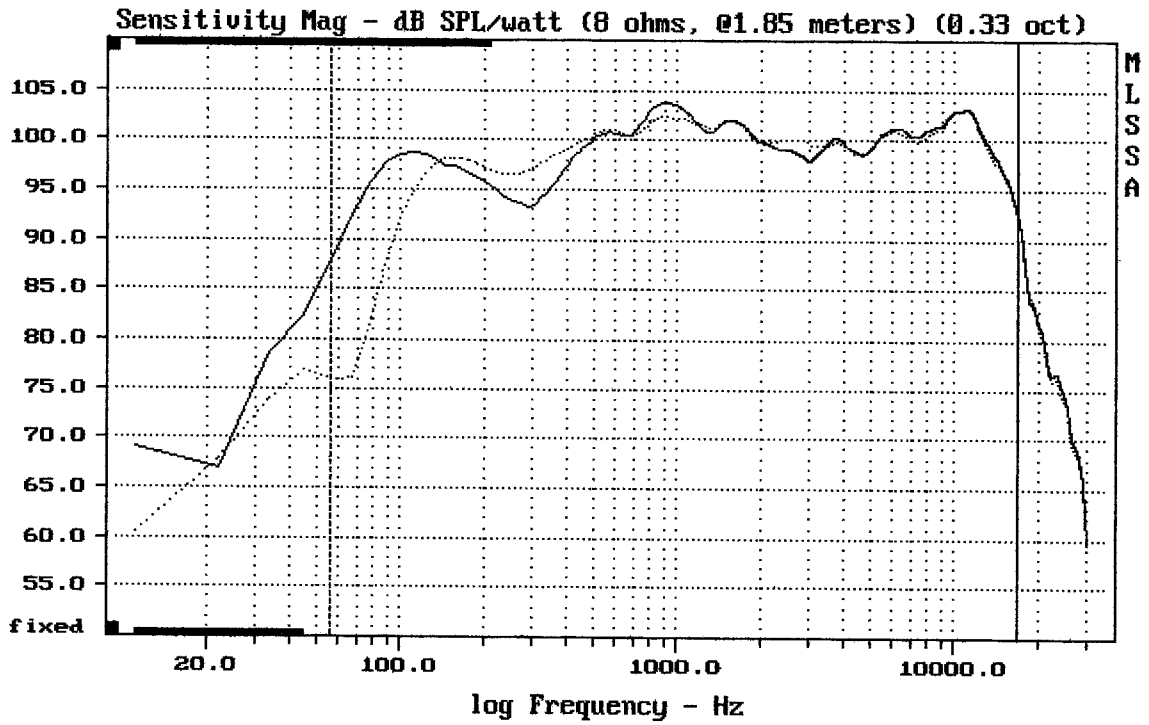

Level (55:17001 Hz) = 99.46 dB SPL/watt (8 ohms, @1.85 meters) (0.33 oct)

DELTA 15 + CD140NEW + A8080

MLSSA: Frequency Domain

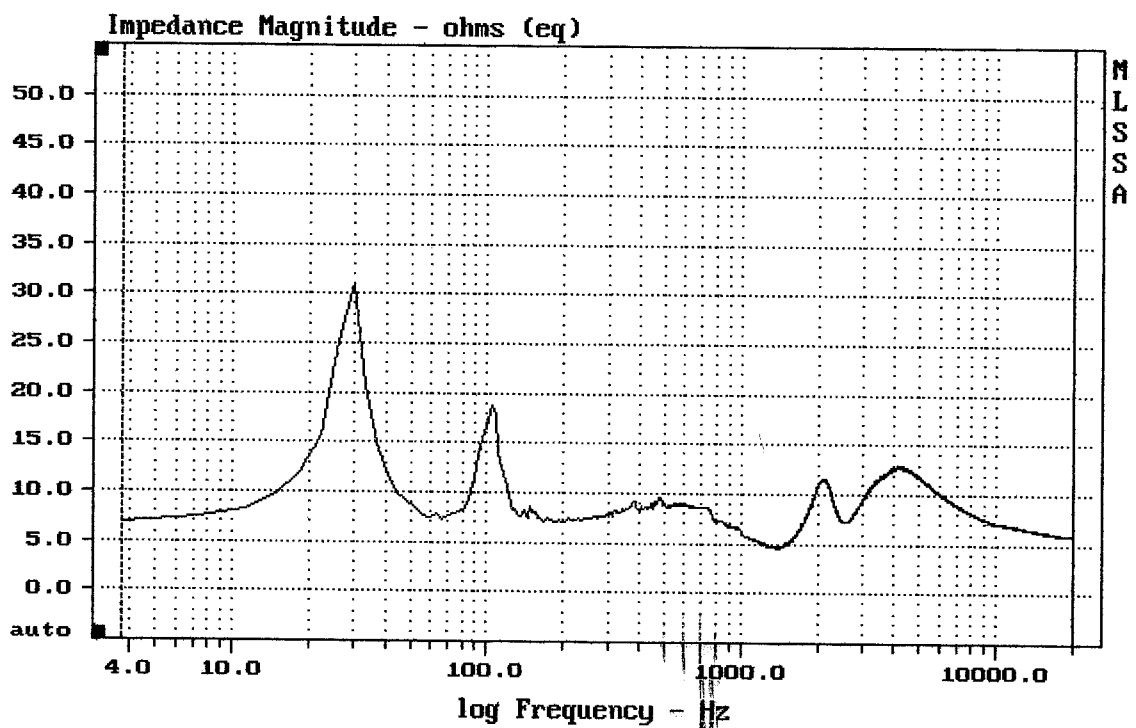

mean: 7.75, rms: 8.028, std: 2.093, max: 31.13, min: 4.558

DELTA 15 + CD140NEW + A8080