

## Sestava: B&C Speakers 15CL76 + Selenium D3300Ti + Megaton C9060

Osazení:

- B&C Speakers 15CL76 8/ohm

<http://eshop.prodance.cz/15cl76-8-ohm/d-94746/>

- Selenium D3300Ti 16/ohm

<http://eshop.prodance.cz/d3300ti-16-ohm/d-97479/>

- Megaton C9060 zvukovod

<http://www.prodance.cz/c9060-zvukovod.html>

Schéma výhybky:

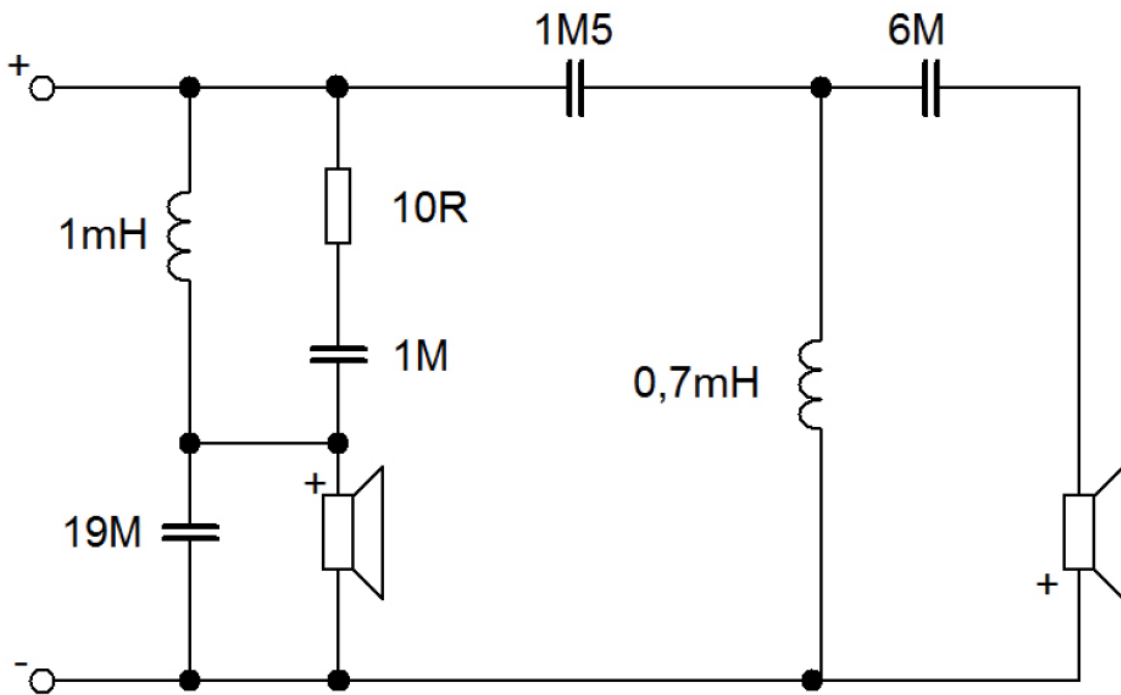

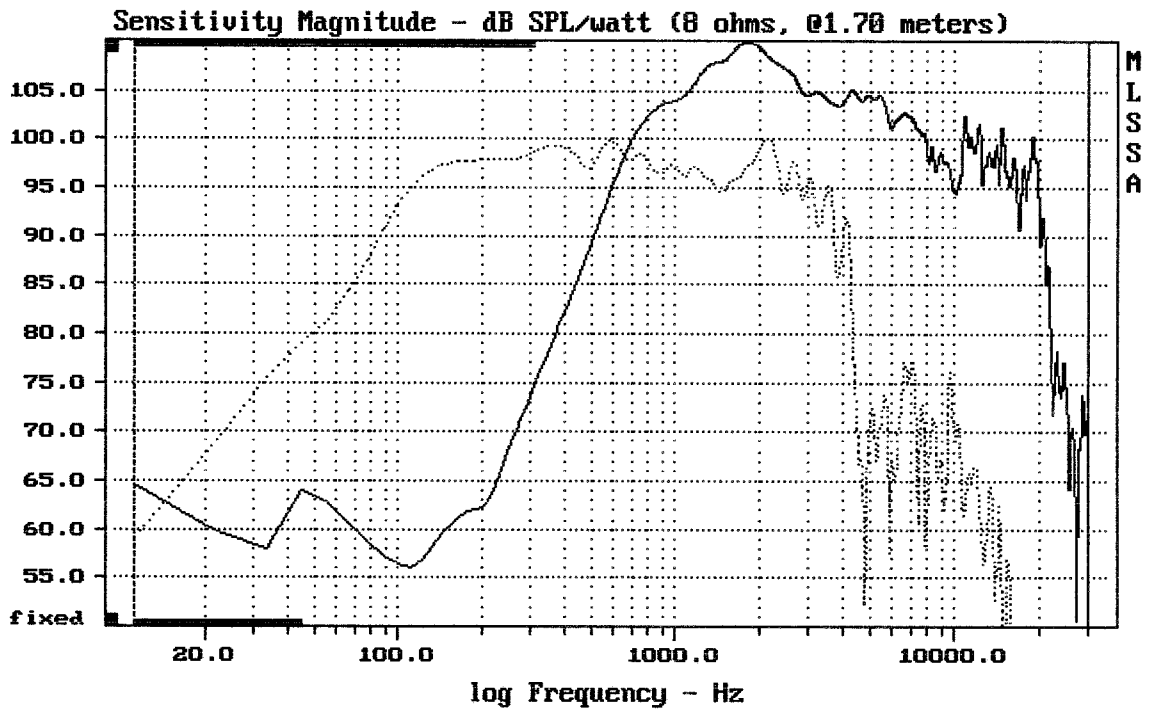

CURSOR:  $dy = -43.3126$   $x = 30007.1014$  (2704)

15CL76 + D3300TI/16 + C9060

MLSSA: Frequency Domain

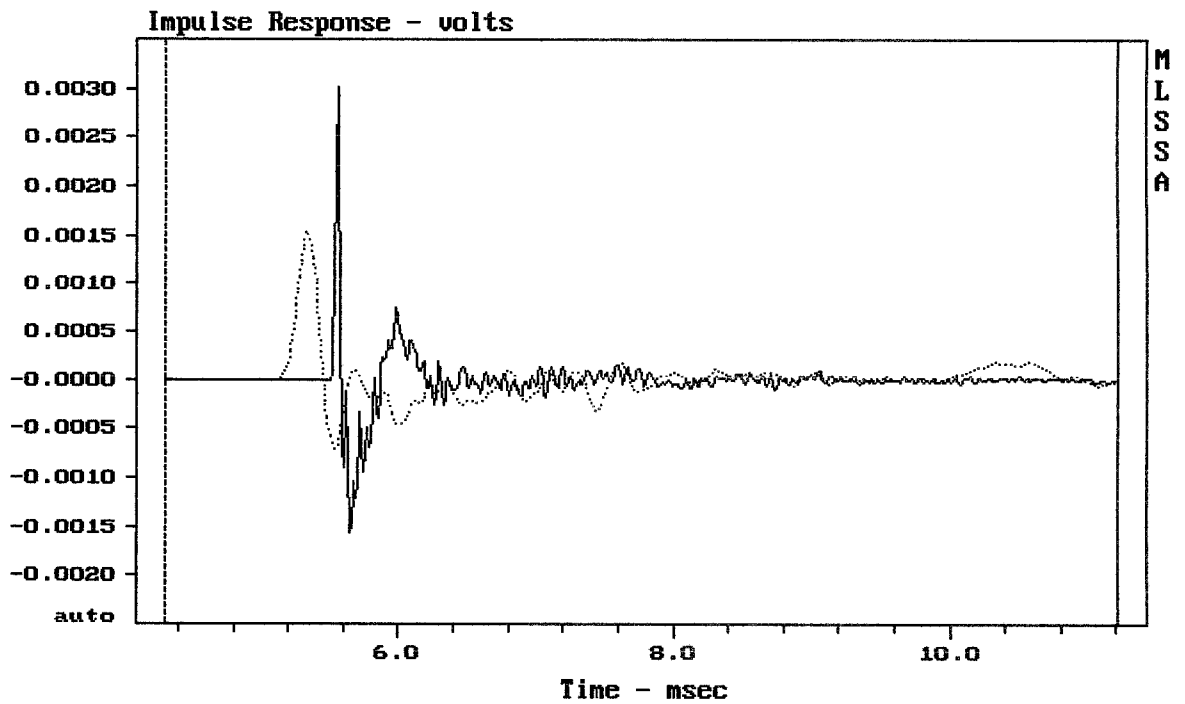

CURSOR:  $dy = 2.08855e-006$   $x = 11.2090$  (1019)

15CL76 + D3300TI/16 + C9060

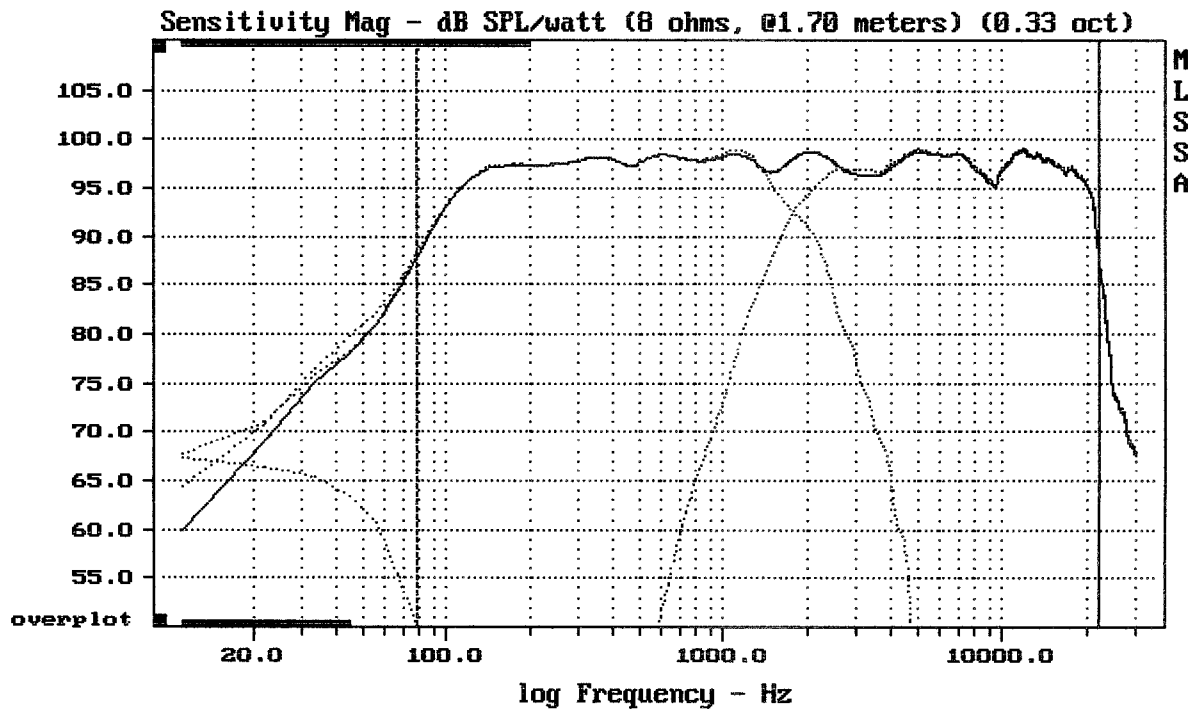

Level (78:22006 Hz) = 97.41 dB SPL/watt (8 ohms, @1.70 meters) (0.33 oct)

15CL76 + D3300TI/16 + C9060

MLSSA: Frequency Domain

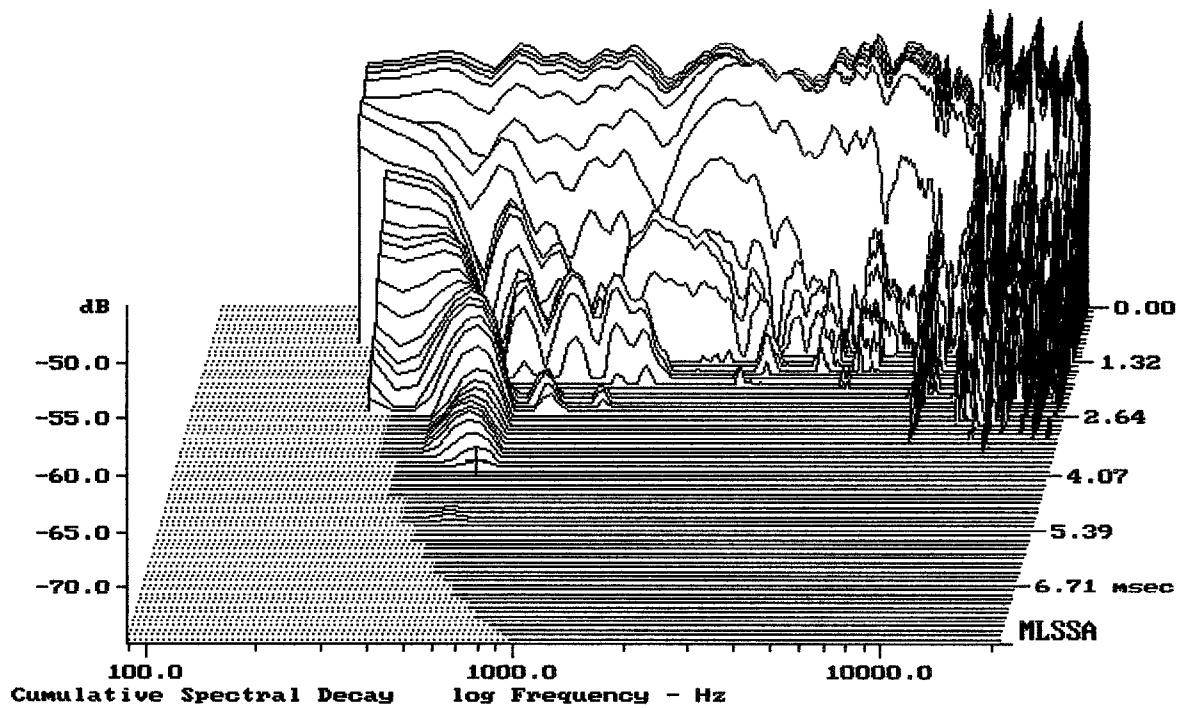

-74.46 dB, 577 Hz (13), 3.850 msec (36)

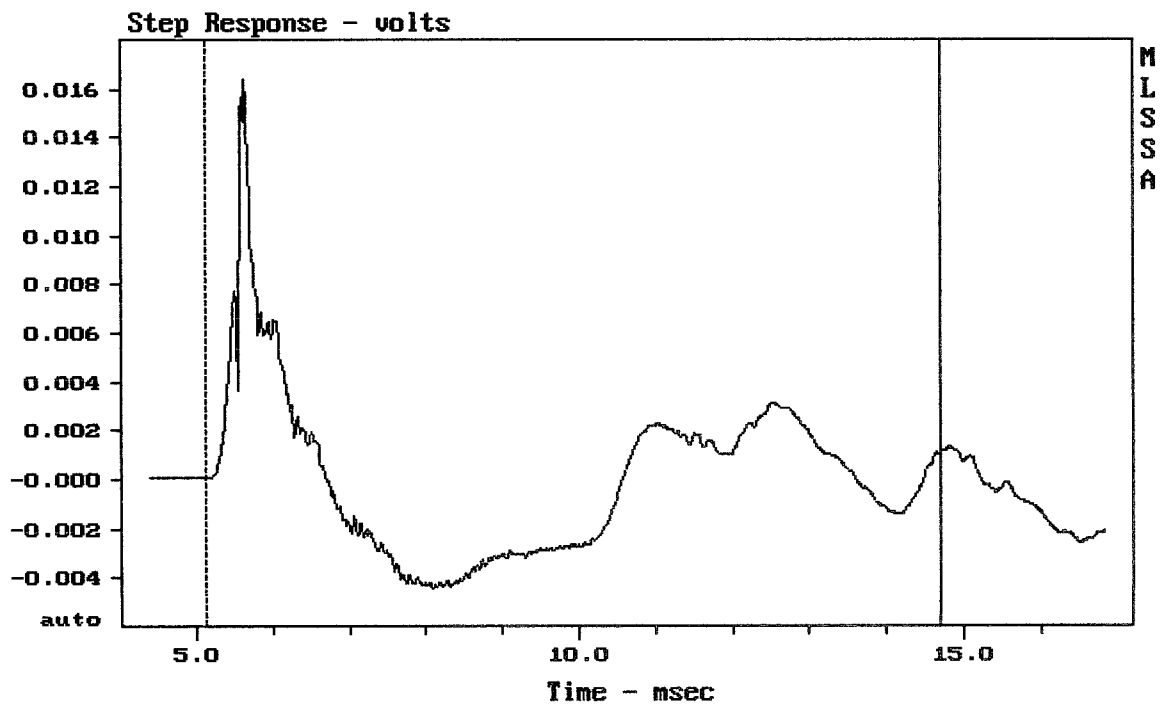



---

mean: 3.733e-005, rms: 0.003289, std: 0.003289, max: 0.01633, min: -0.004435

---

15CL76 + D3300TI/16 + C9060

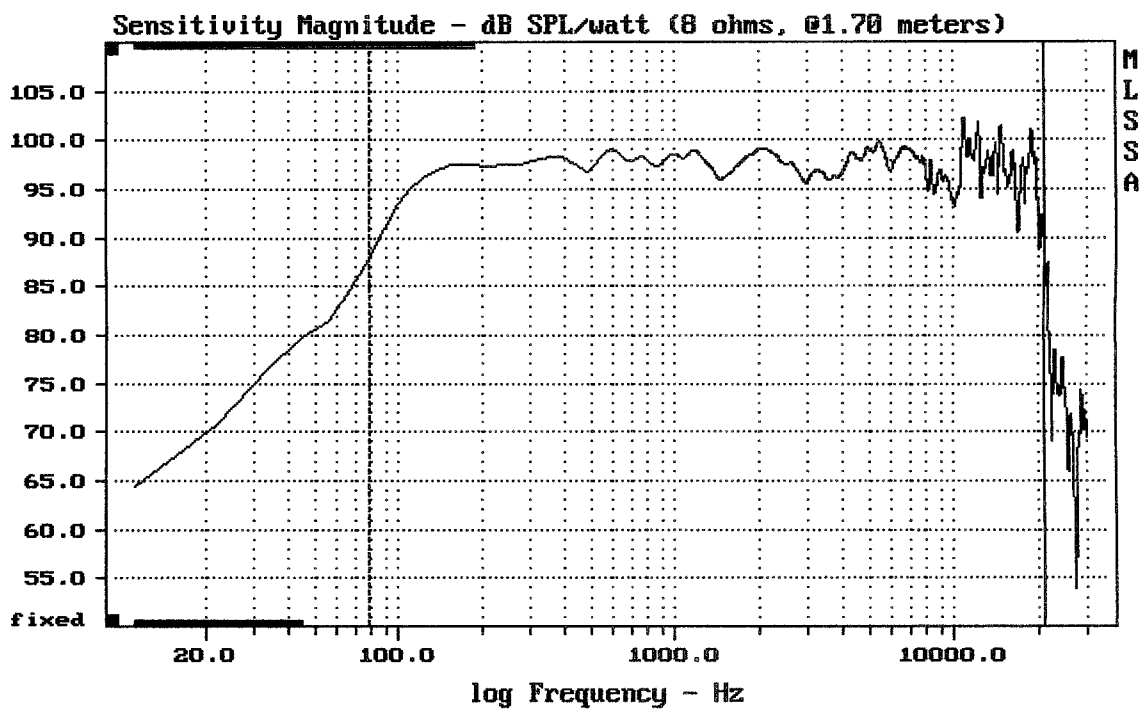
MLSSA: Time Domain





---

mean: 97.39, rms: 97.64, std: 1.87, max: 102.17, min: 87.87

---

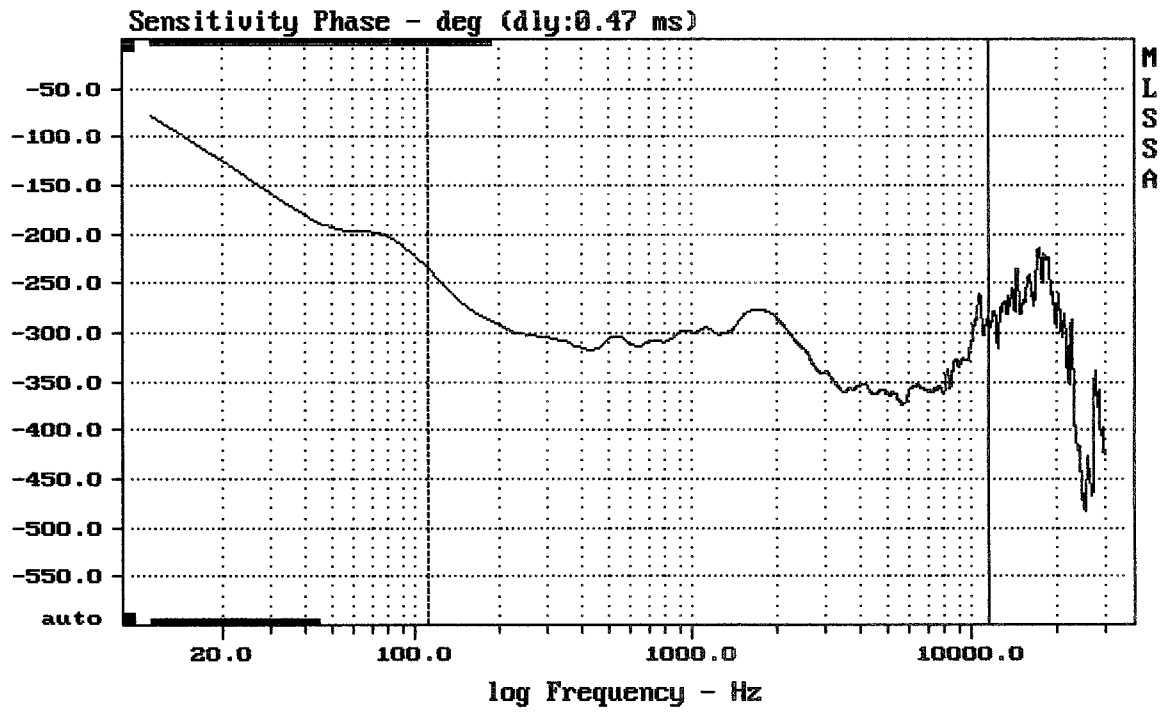
15CL76 + D3300TI/16 + C9060





---

mean: -330, rms: 331.4, std: 30.78, max: -234.5, min: -373.4

---

15CL76 + D3300T1/16 + C9060

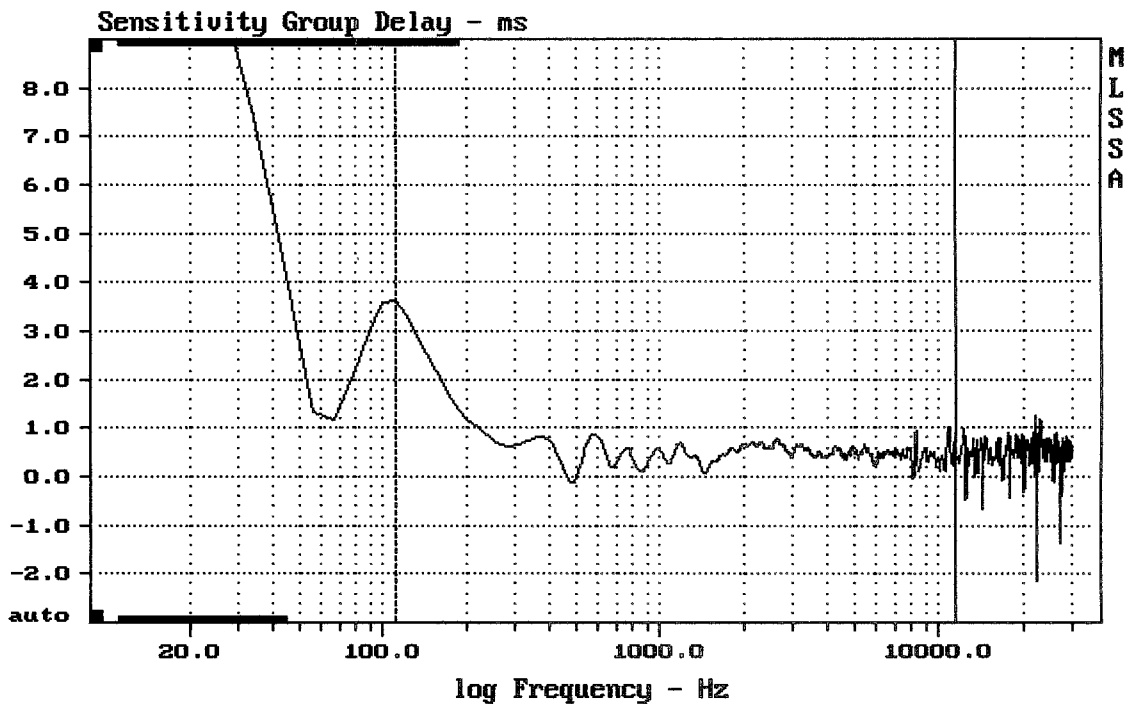
MLSSA: Frequency Domain





---

mean: 0.4843, rms: 0.5453, std: 0.2506, max: 3.64, min: -0.1198

---

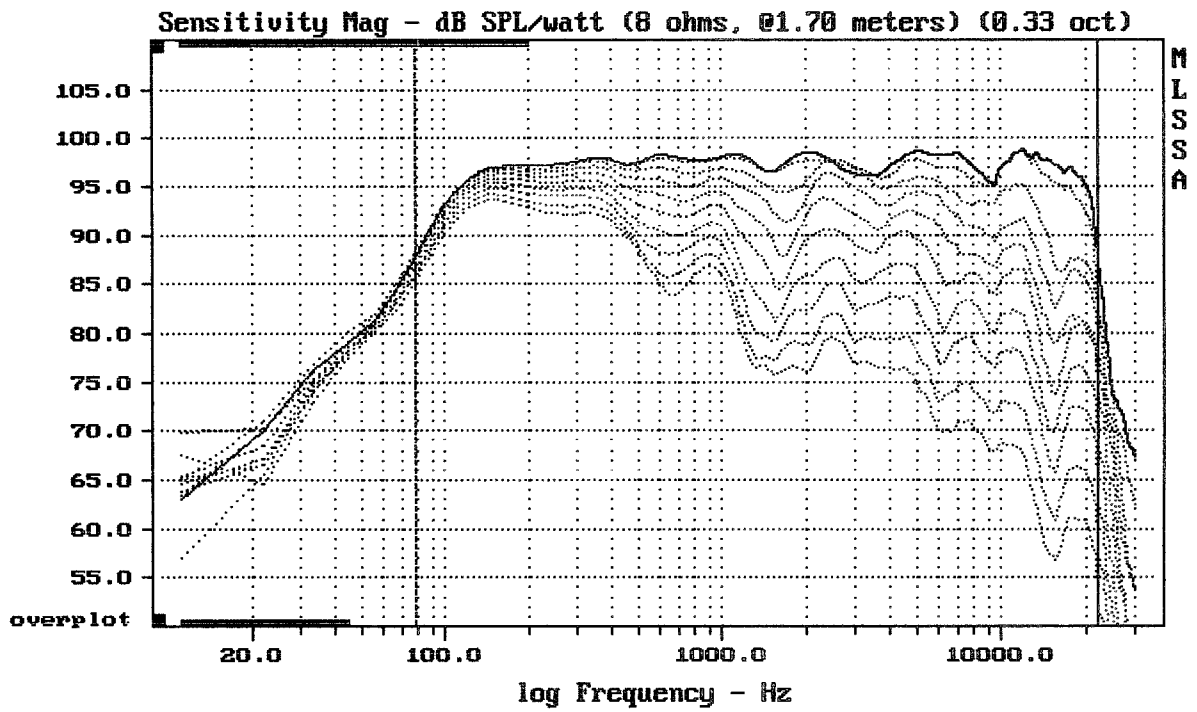
15CL76 + D3300T1/16 + C9060





---

Overlay Compare: dev= +27/-11, std= 7.7, avg= -29

---

15CL76 + D3300TI/16 + C9060

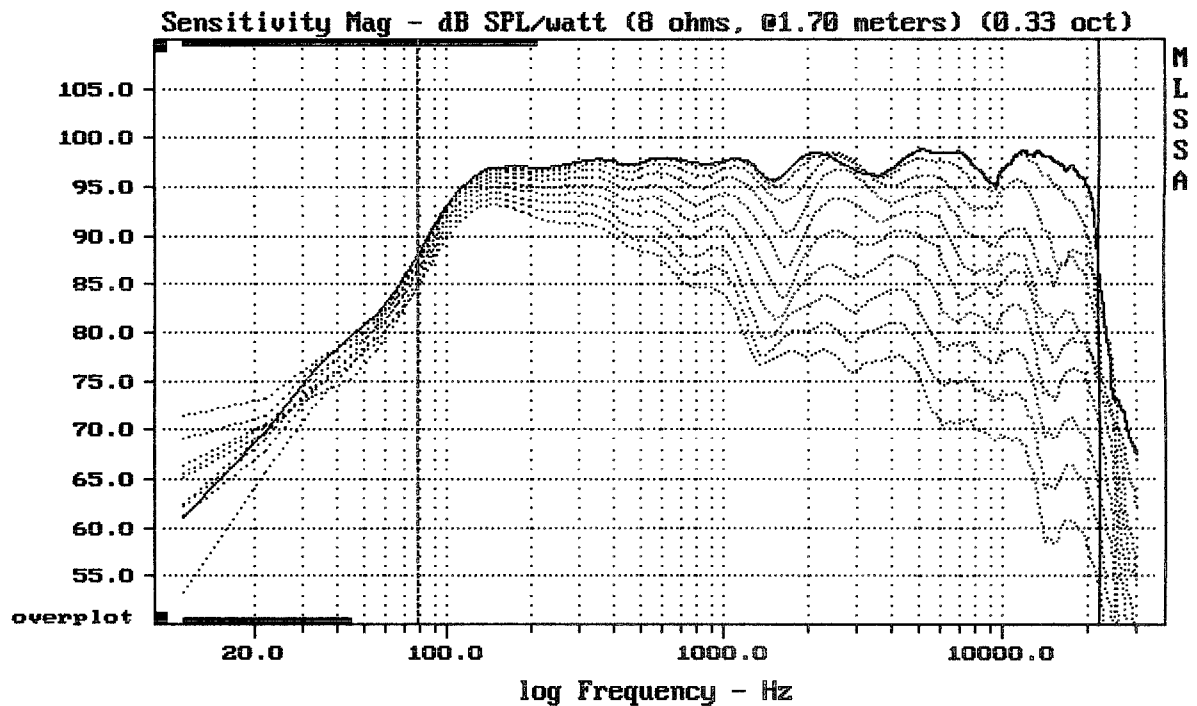
MLSSA: Frequency Domain





---

Overlay Compare: dev= +26/-10, std= 7.9, avg= -29

---

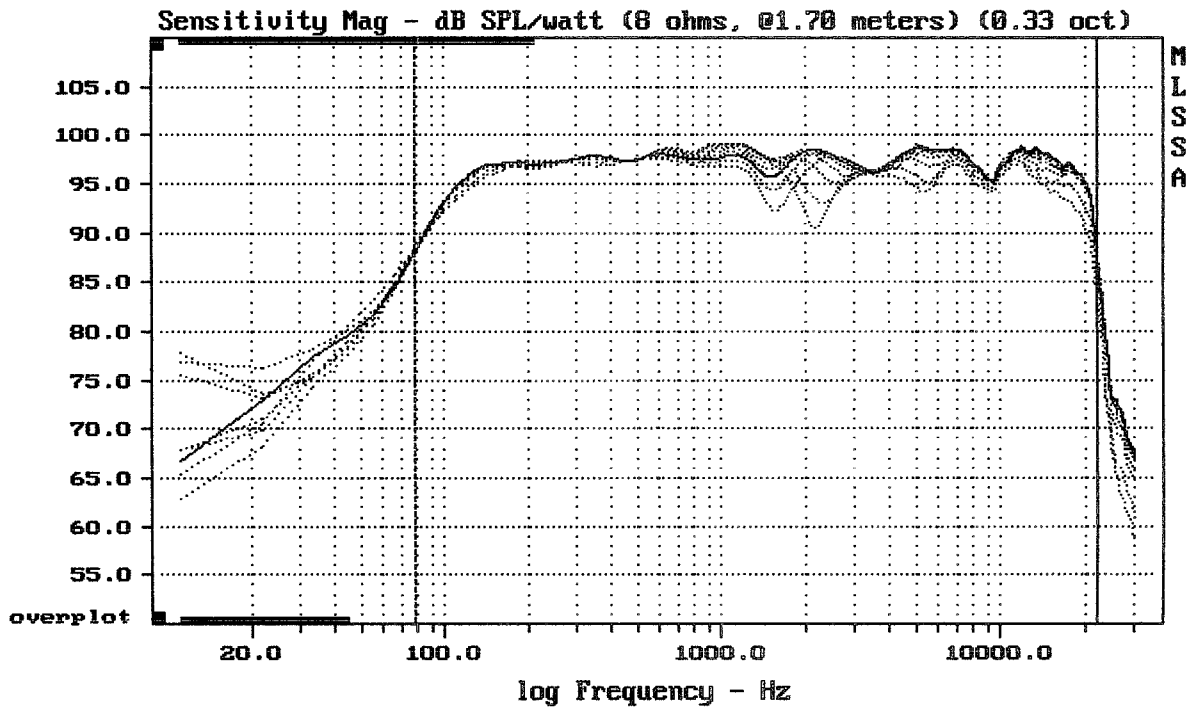
15CL76 + D3300TI/16 + C9060



CURSOR: y = 84.1246 x = 22005.9475 (1983)

15CL76 + D3300TI/16 + C9060

MLSSA: Frequency Domain

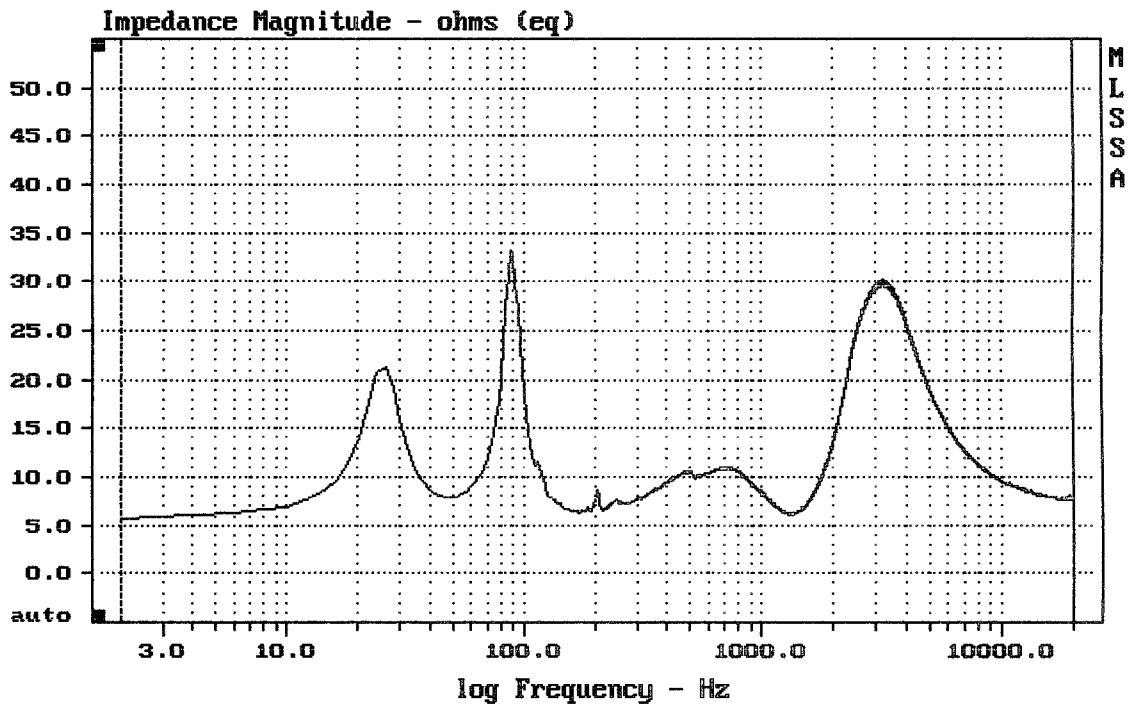

mean: 11.93, rms: 13.44, std: 6.18, max: 33.09, min: 5.66

15CL76 + D3300TI/16 + C9060